

TOSHIBA

東芝壓縮式抽濕機 使用說明書 <家庭用>



型號

RAD-Y200H

RAD-Y250H

RAD-Y300H

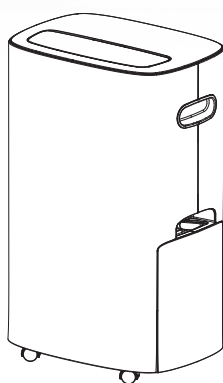

- 感謝使用東芝壓縮式抽濕機
- 為了使您能安全正確地使用本機，請在使用前仔細閱讀說明書
- 本手冊含重要操作指引，請妥善保管，以備日後之用。

與冷氣機不一樣，壓縮機式抽濕機沒有使房間變冷的功能。反而在使用時會因機體發熱提高室溫。

目錄

安全注意事項	2~4
各部分名稱	5~6
功能選擇	7
衣類乾燥	8
準備及確認	8
濾網安裝方法	9
運轉的方法	10~12
連續排水時	13
保養注意事項	14~15
運轉及性能	16
遇故障時處理方法	17
規格	18

安全注意事項

請務必遵守

為了使用者或他人的安全及財產保障不受損害，請仔細閱讀並遵守以下內容(表示和圖示)。

表示說明



警告 表示可能導致死亡或重傷



注意 表示可能導致輕傷或物體損害

圖示說明



表示禁止



表示務必遵守



警告

為防止火災、觸電、受傷等



務必遵守

異常、故障時應馬上停止使用
可能會導致火災、觸電、受傷，需
馬上切斷電源，聯繫東芝香港有限公
服務中心檢查及修理。

例如：

- 總開關保險絲短路
- 混入其他異物或水
- 機體漏水
- 電源線和插頭過熱或電源線損壞
- 運轉聲音過大
- 按鍵不靈敏
- 運轉時發出焦味



禁止拆卸

禁止拆機、修理、改造
可能會導致火災、觸電、受傷。
如需維修請聯絡東芝服務中心



禁止

發熱物體不可靠近 (如暖爐)
塑膠零件溶解會引起火災

抽濕機的使用說明



禁止

- 禁止在附近放置及使用噴霧器，易造成火災和爆炸。
- 導風板，進風口和出風口蓋縫隙不可塞入棒狀物和異物，內部風扇高速運轉時可能造成損傷。

- 避免電源線破損或加工；
放置重物、加熱、拉扯所產生的破損，
可能導致火災或觸電。
- 請勿使用損壞的電源線；
使用損壞的電源線可能導致短路、火災或
觸電；請諮詢購買的經銷商或服務站。
- 拔下電源插頭時請勿強拉電源線，
如果拉扯電源線有可能損壞電源線導致短路、
火災、觸電。
- 在移動或收起抽濕機的時候，
請勿拉扯電源線，
這樣可能會造成短路或損壞電源線內部
的導線，並可能導致火災或觸電。

警告

電源、電源插頭、電線



務必遵守

**以下事項必須遵守
可能會導致觸電和火災。**

- 使用220V的交流電插座
- 不可使用延長線。
- 要確認插頭是否插妥
- 定期清理插頭上的灰塵和污垢。



禁止

以下異常情況禁止使用

可能會導致漏電、火災、發熱、短路、
起火、故障等。

- 插頭損壞、電線損毀及插座鬆動時
不可使用。
- 電源線不可損毀、用力彎曲、拉扯、
扭曲重壓、被腳輪及門夾住、加
工、加熱。
- 請不要在連轉停止前斷電。
使用時不可拉扯電源線。



禁止濕手 不可用濕手插拔插頭。
可能會導致觸電。

注意

使用場所



務必遵守

以下異常情況禁止使用

- 擺放於平穩的地方或傾斜度2°
以下的地方使用
- 否則運轉聲會變大或令機體移動、傾
斜，導致水箱水溢出而弄濕傢俱
等，並可能導致觸電、漏電和火災。
- 機體附近不可放置其它物品可能會
導致發熱、起火和產生故障。



禁止

不要在以下場所使用

- 容易觸水的地方（浴室等）
可能會導致觸電、漏電和火災。
- 會洩漏可燃性氣體，油的場所。抽
濕機附近有易燃氣體，可能
會導致火災和爆炸。
- 桌上等高處，機體掉落時可能會損
壞。
- 抽濕機及排水管周圍的溫度不可低
於冰點，排水管內的水可能會結冰
並在融化時弄濕傢俱，導致觸電。
漏電或火災。水箱同時會破裂及漏
水。
- 使用於藥物及化學品的場所，如醫院
工廠、實驗室和美容院等。
因空氣中的化學品會使抽濕功能下降
可能會導致漏水、發熱、起火和火
災。
- 屋外（陽光直射、雨水淋濕的場所）
可能會導致漏水、發熱、起火和火
災。
- 本產品只限室內使用
- 不要在狹窄密閉的地方使用，可能
會導致發熱或火災。
- 抽濕機吹出的風不可直接對著燃燒
器具，可能會導致不完全燃燒。

安全注意事項(續)

注意

電源插頭，電線



- 拔插頭時，不可拉扯電源線，要爪握插頭拔出。處理不當可能會導致觸電，短路而引起火災。



拔插頭

- 長時間不使用時請拔掉插頭。絕緣不好的情況下會導致觸電、漏電和火災。



禁止

不可用作以下用途

- 食品、醫藥品、美術品、資料保存及特殊用途會導致保存質量下降。
- 抽濕後的水不可飲用及作飼養使用，會危害身體健康。



禁止

- 不適用於幼童，小童，長者及不能獨立操作本機器的人。長時間對著吹風會影響身體健康及產生脫水現象。

保養



拔插頭

- 待運轉停止後才拔出插頭，否則插頭可能會受損，導致觸電。



務必遵守

- 長時間連續運轉時，進風柵格和排水管應定期拆下清洗。否則可能會導致機體發生過熱，漏水現象。長時間在同一場所使用時，請檢查機體底部有沒有漏水。漏水會弄濕地板及造成附近物品損毀。



禁止

- 抽濕機不可直接用水清洗。可能會導致漏電、觸電。

抽濕機的使用



務必遵守

- 使用連續排水時應檢查排水管道，若弄濕傢俱可能會導致觸電、漏電、火災。
- 檢查排水管是否彎曲或接受到機體上。



禁止

- 注水的容器例如花瓶，不可放置在產品的上方。可能會導致觸電，漏電，火災。
- 不可傾倒、掉下、可能會導致破損、漏水、觸電、故障。
- 不可取下水箱的浮子。可能會導致機體不連轉、溢水弄濕傢俱觸電、漏電
- 不可堵塞或放置濕衣服到進風口或出風口。可能會導致發熱、起火、衣物損壞。
- 不可直接對植物吹風。會受影響。
- 請不要使用噴霧式殺蟲劑或揮發性稀釋劑擦拭機體。可能因為破損導致傷害及漏水弄濕屋內財物，或由於短路導致火災或觸電。
- 請不要坐或爬到機器上面，有可能由於滑落、跌倒導致傷害。

移動、存放機體



務必遵守

- 移動機器時，應先停止運轉，倒掉水箱中的水，再握緊把手移動。可能會弄濕傢俱、觸電、漏電、火災。



禁止

- 腳輪在移動中受阻時應停止向前，轉換移動方向。可能會導致地板或毛毯損壞
- 不可在傾倒狀態下移動和存放機體。可能會導致損壞、漏電、觸電、故障、發出異常聲音。

各部分名稱

正面

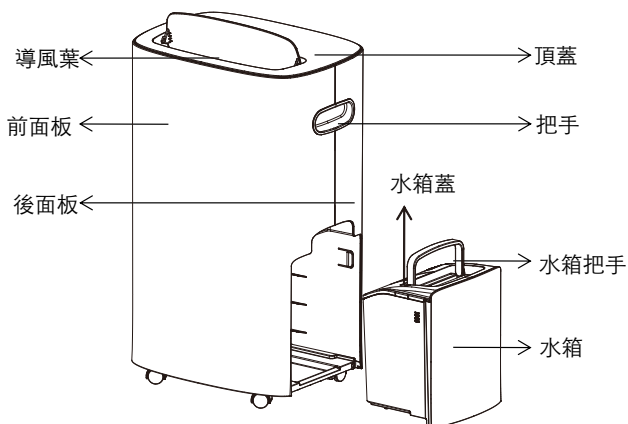

背面

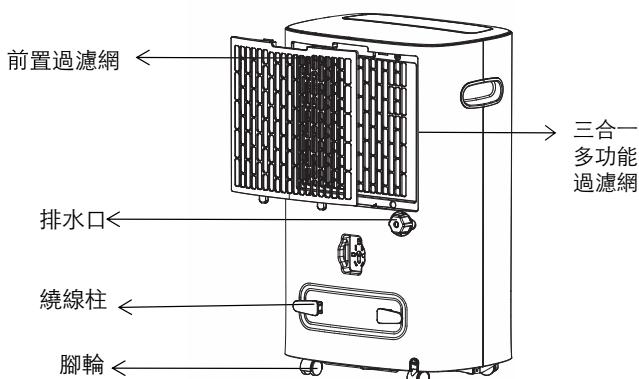

水箱

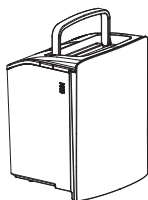

要求

水箱的浮子不可取下及拆卸。若取下浮子，就無法檢知滿水，若漏水可能會導致機體不能正常運作。

設置場所

為了使抽濕機有效的運作，請按右圖放置，如果空間不足，可能會導致除濕機能力下降。

注意

- 開動抽濕機前，請將水箱中的水清空。
- 抽濕機運作時請減少開門窗，這樣做可以節省能源。
- 安放抽濕機的位置，務必在機體周圍預留一定的空間，要求上方最小50厘米，前後左右最小20厘米。如右圖。
- 本機在使用時發現噪音大時：建議在本機下墊上墊子或減震橡膠板等，這樣可以減少振動和噪音，還能減少木地板或地毯的凹陷。

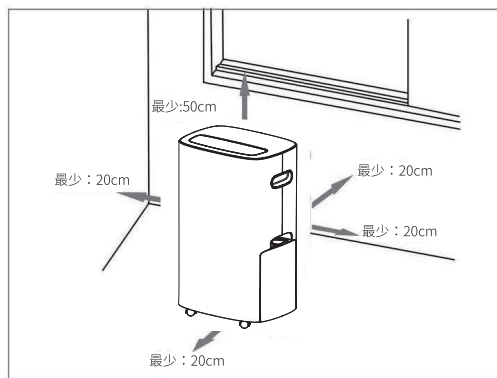

各部分名稱(續)

控制面板

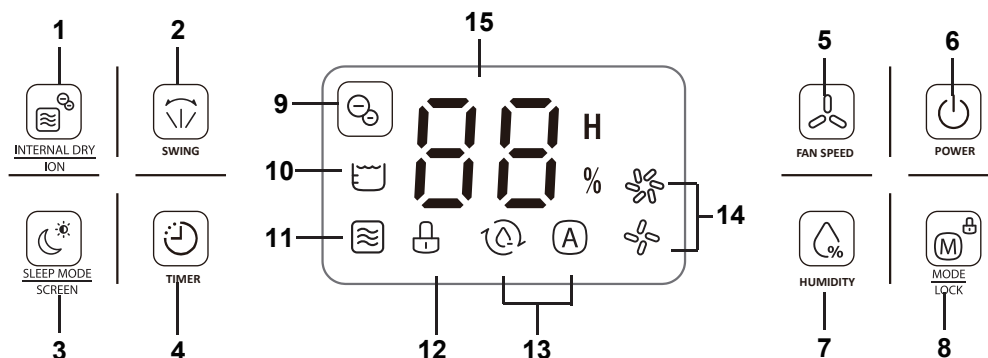

按鍵功能

1. **功能鍵**: 機體內部乾燥功能, 負離子功能;
2. **擺風鍵**: 擺風功能;
3. **睡眠鍵**: 睡眠模式;
4. **時間掣**: 定時設置;
5. **風速鍵**: 調整送風速度;
6. **電源鍵**: 開啟/關閉機器;
7. **濕度調節鍵**: 設定濕度, 30%–80%循環;
8. **模式鍵**: 自動抽濕模式, 乾衣模式;

顯示圖案

9. **負離子圖案**: 負離子功能運作指示圖案, 長按負離子鍵3秒此圖案顯示;
10. **水滿圖案**: 水箱滿水時, 顯示此圖案;
11. **機內乾燥圖案**: 機內乾燥功能運作指示圖案, 按下正負離子鍵顯示此圖案;
12. **童鎖圖案**: 童鎖功能運作指示圖案, 長按模式鍵3秒顯示此圖案;
13. **模式圖案**: 左邊為乾衣模式圖案, 選擇乾衣模式時顯示此圖案; 右邊為自動除濕模式圖案, 選擇自動除濕模式時顯示此圖案;
14. **風速圖案**: 上方為高風速圖案, 選擇高風速時顯示此圖案; 下方為低風速圖案, 選擇低風速時顯示此圖案;
15. **顯示屏**: 環境濕度顯示, 濕度設置, 以及定時狀態顯示定時時間。

功能選擇

- 詳細操作方式請參照11~13頁

以下情況時

想對房間除濕時

想令房間除濕，抑制天花板、牆壁上的水珠及發霉時



連轉種類

想保持合適的濕度時

- 自動抽濕模式

自動抽濕，選中此頁，如果房間濕度>設定濕度+5%，則壓縮機啟動，風機設定風速運行，如果房間濕度<設定濕度-5%，則壓縮機停止，風扇停止運轉，如果房間濕度在設定濕度+5%到設定濕度-5%之間，整機按原運行狀態運行，設定濕度的初始值為50%

- 乾衣模式

- 開啟乾衣模式下，不論房間裡的相對濕度如何，壓縮機都會啟動，配合高風速運行，風速亦可調節。

想乾燥衣物時

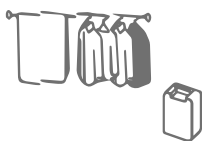

以暖風進行乾燥

- 調教風速鍵[強]或風速鍵[弱]
- 請放在抽濕機的風容易吹乾衣物的地方。(9頁)

注意

- 運轉時會有以下聲音、抽濕機底

背面發出
[咻咻]、[咕—咕—]的聲音
機體開始運轉時會有令凝劑的循環聲。
循環穩定後聲音會變小。

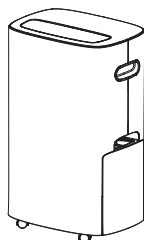

屬於正常現象。

抽濕機底部有[咕]、
[嗡嗡]的壓縮機運轉聲。

因壓縮機運轉，此處
溫度會變高。

機體內部乾燥功能

按下功能鍵啟動機體內部乾燥功能，能防止機內長霉，再按下功能鍵則關閉此功能。

衣類乾燥

正確使用乾衣模式

- 濕衣物需要等距離擺放
出風口應正面對著衣服進行乾燥，才能乾得更快，衣服之間等距離擺放才會乾得更快。
- 抽濕機的擺放位置
定時變更抽濕機及衣服位置，衣服會乾得更快。
- 根據不同衣服種類變換擺放位置
 - 厚衣服—難乾，正面迎風吹。
 - 牛仔褲或裙 - 易乾，離機體較遠吹乾。
 - 薄衣服 - 易乾，遠離機體的地方吹。
- 衣服乾燥後要盡快收起
潮濕季節或下雨天氣，已乾燥的衣服需盡早收起，否則會再次受潮。

提示

- 以下情況時，濕衣服比較難乾。
 - 衣服多
 - 衣服厚
 - 衣服排放間距小
 - 曬衣服的房间大
 - 房間的溫度低

準備及確認

水箱的安裝

水箱沒有裝好或滿水時，機體將不能運轉。

取出方法

將手伸進側面水箱上方的把手，輕輕取出水箱。

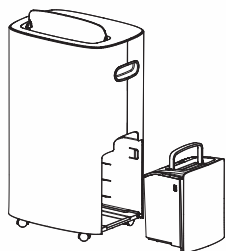

安裝方法

- ① 將水箱蓋裝上，水箱把手旋轉放下
- ② 把水箱輕輕地放回正確位置，再重新開啟抽濕機
 - 講把水箱把手整理好，把水箱輕輕地裝回原位

注意

- 水箱蓋、水箱排水口唯蛻已裝好。否則可能曾漏水。
- 水滿時請把水箱中的水清空。

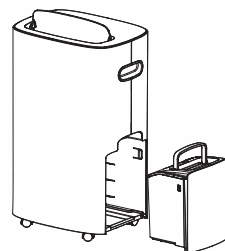

濾網安裝方法

將三合一多功能過濾網安裝於過濾網框，這樣可以淨化空氣。

- 取下機身後過濾網框。
- 將配備的三合一多功能過濾網裝入過濾網框。
- 將過濾網框裝回機體上。

注意 加上濾網後抽濕性能會下降，您可在抽濕時除下三合一多功能濾網，以達致最佳抽濕效果。

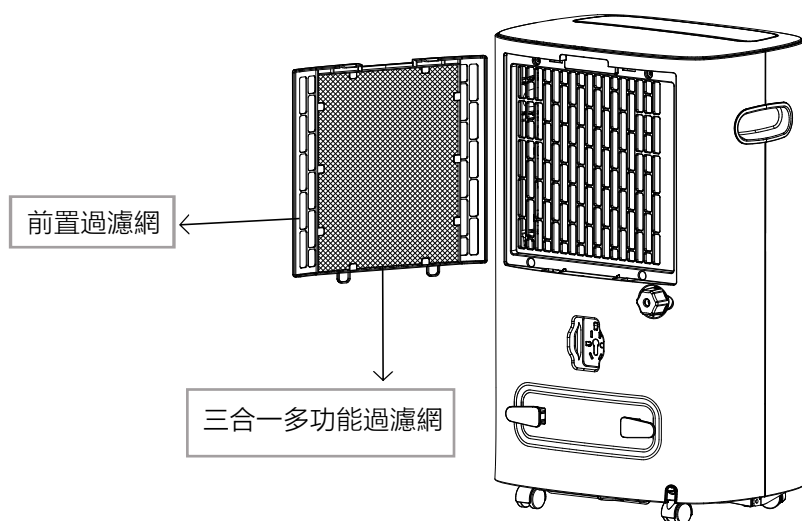

運轉的方法



警告



禁止

電源線不要損毀、彎曲、拉扯、捆綁及以重物壓著，不要壓在腳輪下、門下，也不要加工、加熱。

可能會導致觸電、火災、發熱、短路、起火等故障。

1 接通電源

- 警報響1聲。

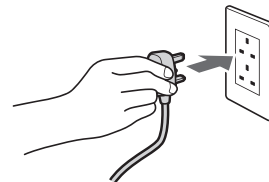

2



電源開關鍵

- 按此鍵開啟和關閉抽濕機。

3



模式鍵

- 在開機或定時開機時按此鍵可選擇運行自動抽濕模式或乾衣模式，所選擇模式對應的指示燈會亮起。
- 長按模式鍵3秒可啟動兒童鎖功能，再長按3秒關閉兒童鎖功能。

4



濕度調節鍵

- 在自動抽濕模式下可設定濕度,在30%-80%之間循環，每5%為一個單位。

運轉的方法（續）

5 風速鍵

- 使用自動抽濕和乾衣模式下可選擇風速，高風或低風之間循環選擇。
-

6 擺風鍵

- 按此鍵開啟和關閉擺風功能。
-

7 功能鍵

- 按下功能鍵啟動機體內部乾燥功能。
 - 長按功能鍵3秒可啟動負離子功能。
 - 再長按3秒關閉負離子。
-

8 睡眠鍵

- 按下此鍵可開啟/關閉睡眠模式，按住為按鍵3秒可關/開啟屏顯功能。
-

9 時間掣

- 24小時定時設置，按下此鍵，設置機器定時開關。在定時模式下，調節時間從1-24小時，每1小時為一個單位。
- 在運轉過程操作時間掣按鍵，可設定定時關機時間。
- 在停止狀態下操作時間掣按鍵，可設定定時開啟時間。
- 如果您想取消定時設置，在定時設置確認時按下時間掣即可。

運轉的方法 (續)

倒水箱水的方法

除濕後的水會流入水箱

- 水箱滿水時，機器停止運轉，[滿水]燈亮，警報[嗶-嗶-嗶-]

1 慢慢的抽出水箱，避免濺水。

2 提起水箱把手，慢慢移動。

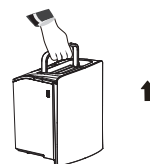

注意

速輯時抽出水箱

- 警報[嗶-嗶-嗶]
- 沾在排水口周圍水可能會滴下，請擦掉。

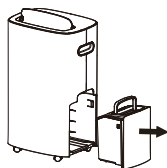

3 傾側水箱，慢慢將水倒出。

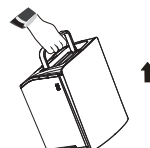

4 將水箱放回機器。

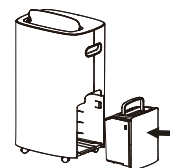

連續排水時 詳見第13頁

移動抽濕機時

注意



禁止

腳輪被卡著時應停止移動，轉移移動方向，可能是被地板或毛毯卡著。

- 在腳輪易被卡著的地方和表面凹凸不平的地方，請提起機器移動。

1 停止運轉、拔掉插頭、倒掉水箱內的水。

2 捲好電源線，緊握機器把手慢慢移動。

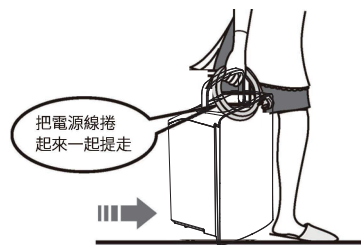

- 避免電源線纏繞腳輪。
遇到台階或改變移動方向時緊握住把手提起機器。

提示

- 若長時間在同一地點使用，地板或毛毯可能會留有印痕。

連續排水時

注意



連續排水時應確認排水管已正確安裝

否則可能會弄濕家具、觸電、漏電、火災等。

提示

- 請檢查排水管是否彎曲，沒有向上傾斜擺放。



禁止

抽濕機機體及排水管的周圍溫度在0°C以下時不可使用。

機體、管內的水一旦結冰，在冰塊融化時可能會弄濕家具，導致

觸電、漏電、火災。水箱可能因破裂而漏水。

與排水地點距離較近時，可直接安裝排水管，連續排水。可長時間運轉，節省倒掉水箱水的時間。

排水管規格

長度：外接水管不可過長（建議長度小於0.6米），水管末端高度須低於機身排水口高度10厘米以上，水管要保持順暢，否則可能無法正常排水。

排水管直徑：內徑9毫米，外徑13毫米。

注意

- 請不要使用伸縮管，會導致水積在管內，不能排出。

處理以下步驟前，先停止運轉，並把電源插頭從插座上拔掉。

- 1 除下機背後面的排水口水蓋，拔出水塞。將9.0 毫米水管連接到排水口上。

- 2 除下機背後面的排水口水蓋，拔出水塞。將標準螺紋的花園軟管裝在螺紋排水口上。

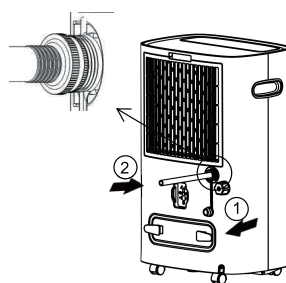
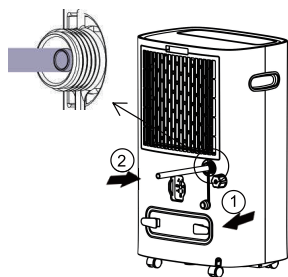

注意

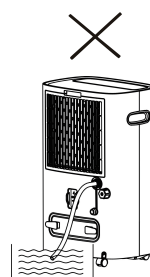
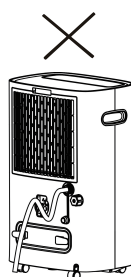
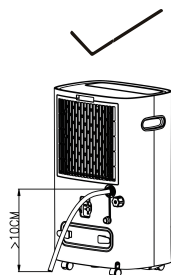

如果您不想經常去倒水箱裡的水，可以在本機後面連接一個排水管(管的內徑為9.0毫米)排水。也可使用，具有標準螺紋的花園軟管，其具有1 $\frac{1}{16}$ 英寸（1.0625英寸或26.98毫米）的外徑和11.5TPI的螺距。

保養注意事項



警告



禁止濕手

不要濕手拔插頭
可能會觸電。



注意



拔插頭

清洗的時候應先切斷電源
否則可能會引致受傷或觸電。



禁止

不可取下水箱的浮體
可能會導致機器不能運轉、漏水、弄濕物品、觸電、漏電。

機體

用柔軟及扭乾的濕布擦拭表面。

- 電源插頭上的灰塵要定期清潔。
- 頑固的污垢要用中性清潔劑沾濕軟布，扭乾後擦拭。
- 操作面板要用乾布擦拭，不可用水擦拭。
- 不要用汽油、天拿水、酒精、石油、去污粉、刷子清洗，會產生變形及刮花。

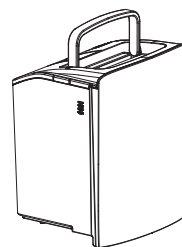

水箱（一週一次）

1 從機內抽出水箱

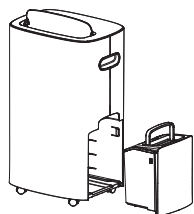

2 打開水箱蓋。

- 水箱蓋向上打開。

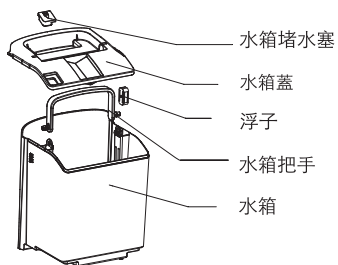

3 清洗水箱內側與水箱蓋

- 請不要用毛刷強行擦拭，易刮花水箱。

4 擦乾水箱外的水，蓋上水箱蓋。

- 水箱把手與水箱蓋縫隙蓋上後安裝好。

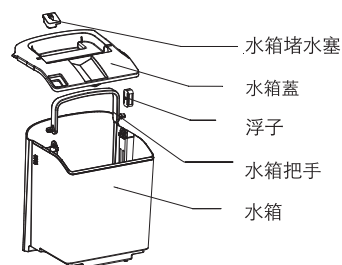

5 裝入機體內

- 放入機體時，水箱放平並慢慢推放至機體最內側。

保養注意事項 (續)

1 三合一多功能過濾網 (2周1次)

過濾網的髒物可用吸塵機吸乾淨

- 把吸塵機的吸力調低。

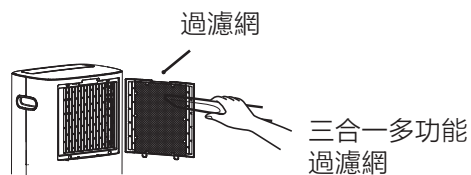

2 取下過濾網框，取出三合一多功能過濾網

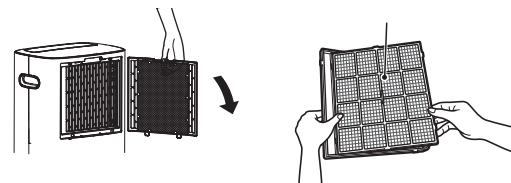

3 三合一多功能過濾網的灰塵，用吸塵機吸乾淨，然後水洗。



4 用毛巾擦乾後，放在通風的地方吹乾。

- 充分吹乾後在安裝。

三合一多功能過濾網禁止事項：

- a、不可以用自來水以外的水清洗
- b、不可揉搓濾網
- c、不可以加熱乾燥
- d、不要直接陽光照射乾燥
- e、乾燥時候不能施加物理壓力

產品型號	過濾網
	零件編號
RAD-Y200H、RAD-Y250H、RAD-Y300H	41226233

運轉及性能

除濕能力

除濕能力（除濕風量[強]運轉）

- 用以下方法運轉時相當於1日（24小時）的除濕量。
（室溫26.7℃、室內濕度60%、不設定濕度、擺葉全開下進行除濕風量[強]運轉）
用其他使用方法運轉和不同的擺葉閉合程度，會使除濕量變小。

室內溫度、濕度和除濕量間的關係

- 室內溫度不變時的除濕量
... ..濕度越高除濕量越高，濕度越低除濕量越低。
- 室內溫度不變時的除濕量
... ..溫度越高除濕量越高，溫度越低除濕量越低。
濕度為60%時的例子

- 機器在設定濕度以下，運轉模式為[設定濕度]時，
會自動停止除濕運轉，風扇停止運轉。
此時除濕量雖會變少，但並非異常。

除濕原理

- ① 吸入空氣經過蒸發器會變冷。
- ② 濕空氣經過蒸發器時表面結霜，
繼而變成水滴會流到水箱裏。

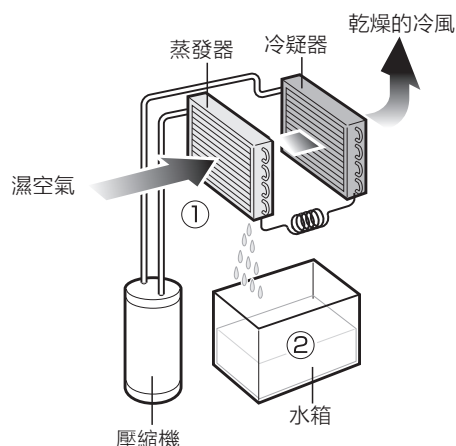

常溫空氣經過蒸發器後，水蒸氣遇冷液化，在蒸發器表面形成水滴。

機器運行中的除霜過程

- 室內溫度約在16℃以下時，機器內部會結霜，為了確保機器正常運行，在除濕過程中通常會每約38分鐘進行一次除霜（每次約8分鐘），此時機器的運轉模式轉為送風運轉。
- 除霜過程中，數碼管會顯示“P1”。
- 除霜過程中，請不要拔掉插頭，及強行停止運轉。

運轉中的室溫上升

- 抽濕機沒有製冷功能
相反會在運轉過程中產生熱能，室溫會上升約1℃~4℃。
- 因須關閉門窗運轉抽濕機，所以會因室內其他使用中的電器產品發熱及陽光照射等令室內溫度上升約1℃~4℃。

運轉聲音

- 除霜過程中，請不要拔掉插頭，及強行停止運轉。
- 運轉開始時，由於冷媒流動聲音會較大，但安定運轉時聲音會變小，這不是異常聲音。

遇故障時處理方法

- 申請修理前，請確認以下問題

故障排除

1. 如果抽濕機出現了以下列問題，可以按以下方法解決。

狀況	可能的原因	解決方法
抽濕機不運作	電源插頭是否穩妥插上？	把電源插頭插在插座上。
	水箱的水是否滿了？ (水箱的水滿了或水箱放置的位置不對)	把水箱裡的水倒掉，然後再把水箱裝回去。
	環境溫度過低或高。	建議在5°C~32°C環境下使用。
抽濕功能效果不明顯	房間的溫度或濕度是否太低？	在乾燥的季節，抽濕量會減低。
	出風口和進風口是否被阻擋？	將阻擋出風口和進風口的物品清理乾淨。
不出風	進風柵格是否被阻塞了？	將阻擋進風柵格的物品整理乾淨。
運行時噪音異常	是否放置不妥，以至本機傾斜或不穩？	請把抽濕機放置於平穩的地方使用。
	進風柵格是否被阻塞了？	將阻擋進風柵格的物品整理乾淨。
	有"嚇嚇"聲	冷媒流動的聲音屬正常現象
有水漏出	排水管連接鬆弛	接好排水管
	排水系統受阻	清除水管阻塞物
有結霜現象	環境溫度較低，處於待化霜狀態	屬正常功能現象，可用內部乾燥功能除霜

2. 顯示代碼說明

顯示代碼	說明
FL	整機處於水滿警報提示
E1	盤管傳感器檢測異常
E2	室溫傳感器檢測異常
P1	整機處於除霜狀態，屬於正常現象
CL	整機處於機內乾燥狀態，屬正常現象
LC	整機處於兒童鎖啟動狀態

規格

1. 產品參數

型號		RAD-Y200H	RAD-Y250H	RAD-Y300H
電源		220V ~ 50Hz		
除濕能力 (L/日)	26.7°C 60%	12	14.9	18
	30°C 80%	21	27	30
額定效率 (W)	26.7°C 60%	215	269	298
	30°C 80%	265	319	358
集水箱容量 (L)		4.0		
防水溢容量 (L)		3.7		
重量 (kg)		14.5	14.5	14.5
外形尺寸 (mm) (長×深×高)		350×260×560		
使用溫度範圍		5°C~32°C		

*安裝三合一多功能過濾網後除濕性能會下降。

2. 熔斷絲參數

電壓： 250VAC

電流： 3.15A



處理：

請勿將廢棄的產品與其他未經分類的廢棄物放置在一起，此種廢棄物應當單獨放置以備其他特殊使用。

一切數據只供參考，產品功能或因技術提升而改動，恕不另行通知。

TOSHIBA

TOSHIBA Compressor Dehumidifier Instruction Manual <Family use>



Model

RAD-Y200H

RAD-Y250H

RAD-Y300H

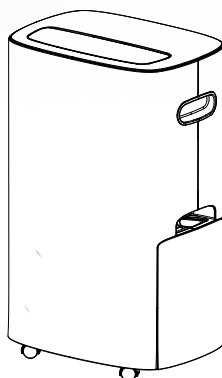

- Thank you for choosing Toshiba Compressor Dehumidifier.
- Please read this Instruction Manual carefully before using the Dehumidifier to ensure proper operation.
- This Manual contains instruction that is essential to the operation of the Dehumidifier, please retain it for future reference.

Compressor Type Dehumidifier differs from air-conditioner that it does not have a cooler function. On the contrary, the room temperature may rise as the Unit produces heat during operation.





Table of Contents

Safety Precautions.....	2~4
Component Parts	5~6
Function Options	7
Laundry Drying	8
Preparation and Confirmation	8
Filter installation method	9
How to Operate	10~12
Continuous Drainage	13
Maintenance Tips	14~15
Operation & Performance	16
Troubleshooting	17
Specifications	18

Safety Precautions

Strict observation

To prevent injury to user or others and damage to property, please carefully read and observe the following precautions presented in signs and symbols.

Sign	Symbol
 WARNING May result in fatal or severe injury.	 Prohibited
 CAUTION May result in minor injuries or property damage.	 Strict Observation

WARNING

To prevent fire, electric shock or injury

 **Strict Observation**

Stop using the Dehumidifier immediately if abnormality or malfunction takes place. Abnormal operation of the Dehumidifier may result in fire, electric shock or injury that the Unit should be switched off and unplugged immediately, then contact Toshiba Repairing Service & Parts Centre for check up and repair. Examples of abnormality

- Short circuit
- Foreign objects or liquid inserted
- Water leaks from the Unit
- Power cord and plug overheated or power cord damaged
- Unusual loud operating noise
- Function keys not working
- Burning smells from normal operation

 **Prohibited**

Do not disassemble, repair or modify the Dehumidifier as this may cause fire, electric shock or injury. Please contact Toshiba Repairing Service & Parts Centre for repair.

 **Prohibited**

Do not put the Dehumidifier near heat-generating devices, such as heater, as they may melt the plastic parts of the Unit that causes fire.

Operating Instruction

 **Prohibited**

- Do not place or apply spray near the Dehumidifier, which may cause fire or explosion.
- Do not insert any foreign objects into the swing Louver, Air Intake or Air Outlet, which may result in injury when the internal fan is running at high speed.

- Do not damage or modify the power cord. Power cords that are damaged, modified, trapped under heavy objects, heated up or stretched may cause fire or electric shock.
- Do not use damaged power cord, which may result in short circuit, fire or electric shock. Please consult your dealer or Toshiba Repairing Service & Parts Centre.
- Do not remove the power plug by pulling the power cord as this may damage the power cord and cause short circuit, fire or electric shock.
- Do not move and store the Dehumidifier by pulling the power cord as this may cause short circuit or damage the wiring of the power cord, and result in fire or electric shock.



WARNING

Power supply, power plug, and power cord



Strict
Observation

The following rules must be strictly observed, or it may cause electric shock and fire.

- Exclusively use 220V AC power sockets
- Do not use an extension cord
- Ensure that the plug is fully inserted into the socket
- Dust off and clean the power plug regularly



Prohibited

Do not operate the Dehumidifier in the following abnormal situations

It may result in electric shock, fire, heat generation, short circuit, ignition, and malfunction etc.

- Do not operate the Unit with damaged power plug or power cord and loose power socket.
- Do not damage, bend, stretch, twist, press, modify, and heat up the power cord, or get it caught under the Casters or doors.
- Do not disconnect the power supply until the unit comes to a complete stop. Do not drag the power cord when the unit is operating.



No Wet Hand

Do not plug in or unplug the Dehumidifier with wet hand. Doing so could result in electric shock.



CAUTION

Set up environment



Strict
Observation

Do not operate the Dehumidifier in the following abnormal situations

- Place and use the Dehumidifier on a stable and leveled surface with a slope less than 2°.
- An unlevelled surface will cause excess operating noise or vibration, or leave the Unit in a tilted position that the water in the tank may overflow and wet the floor and surrounding objects, which in turn result in electric shock, electric leakage and fire.
- Do not place any objects on or close to the Dehumidifier, it may result in heat generation, fire and malfunction.



Prohibited

Do not install the Dehumidifier in the following setting

- A place where it is likely to come into contact with water such as bathroom. This could cause electric shock, electric leakage and fire.
- Where the unit may be subject to oil or flammable gas leakage. The flammable gas around the Dehumidifier could cause fire or explosion.
- Elevated position such as on a table, as the Dehumidifier may drop and cause damage to the Unit.
- Where the ambient temperature of the Dehumidifier and drain hose is below freezing point. Water inside the drain hose may freeze, that may wet the surrounding objects when it thaws, and result in electric shock, electric leakage or fire. The Water Tank may consequently break and leak.
- Where drugs and chemicals are used, such as hospital, factory, laboratory and beauty salon. Chemicals in the air may affect the performance of the Unit, cause leakage, heat generation, ignition and fire.
- Outdoor location where the Dehumidifier is exposed to direct sunlight or rain that may result in leakage, heat generation, ignition and fire.
- This Dehumidifier is for indoor use only.
- Where space is narrow and enclosed that may cause heat generation or fire.
- Do not use combustion appliances in the path of the airflow of the Dehumidifier, as this may cause incomplete combustion.

Safety Precautions (Cont.)

CAUTION

Power plug and power cord



Strict
Observation

- Do not remove the power plug by pulling the power cord, but by grabbing hold of the plug, as mishandling may cause result in fire caused by electric shock and short circuit.



Unplugging

- Unplug the Unit from the power source when not using it for an extended period of time. Insufficient insulation may cause electric shock, electric leakage and fire.



Prohibited

Do not use the Unit for the following purposes

- Food, pharmaceuticals, artworks, data storage, and special purpose. Doing so may deteriorate the quality of the items stored.
- Water from the Dehumidifier is not suitable for human or animal consumption as it is hazardous to health.



Prohibited

- This Dehumidifier should be kept away from infant, children, elderly person or anyone who cannot operate the Unit independently. Pointing airflow from the Unit directly at a body for a prolonged period of time may be harmful to health and cause dehydration.

Maintenance



Unplugging

- Unplug only after the unit comes to a complete stop. Otherwise, the plug may be damaged and cause electric shock.



Strict
Observation

- After running the Dehumidifier for a long period of time, Air Intake and Drainage Hose should be taken down to clean regularly. Otherwise, overheating or leakage may occur. Please check for leakage underneath the Unit after using the Unit in the same spot for a long period of time. Leakage will wet the floor and ruin surrounding items.



Prohibited

- Do not wash the Dehumidifier with water. This may cause electric leakage and electric shock.

Operating the Dehumidifier



Strict
Observation

- Check the Drainage Hose during the Continuous Drainage Operation. Wetting furniture may result in electric shock, electric leakage, and fire.
- Check to ensure the drain hose is free of bent and properly inserted.



Prohibited

- Do not put objects filled with water, such as vase, on the Unit. This may cause electric shock, electric leakage and fire.
- Do not tilt or drop the Dehumidifier or it may result in damage, leakage, electric shock and malfunction.
- Do not remove the Float from the Water Tank. This may cause intermittent operation of the Unit, leakage that wet the surrounding items, electric shock and electric leakage.
- Do not block the Air Intake and Air Outlet. Do not cover the Air Intake and Outlet with laundry. This may cause heat generation, fire, and damage to the clothing.
- Do not point the airflow directly at plants.
- Do not use pesticide spray or volatile thinner to wipe the body of the Unit. This may cause damage to the Unit and leakage that wet the property, or short circuit that result in fire or electric shock.
- Please do not sit or climb on top of the machine, it may injury caused by slipping or falling.

Moving the Unit and Storage



Strict
Observation

- Before moving the unit, always switch it off, unplug and remove water from the Water Tank, and firmly hold the Handle to lift it. Mishandling may wet the surrounding items, electric shock, electric leakage and fire.



Prohibited

- Stop pushing forward if the Casters are unable to roll smoothly. This may cause damage to the flooring or carpet.
- Do not move or store the unit in horizontal position. This may cause damage, electric leakage, electric shock, malfunction and abnormal noises.

Component Parts

Front

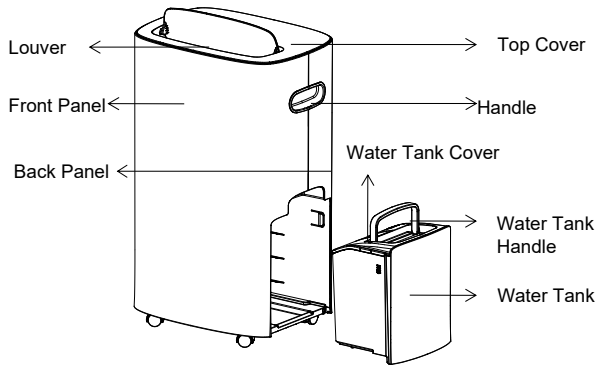

Rear

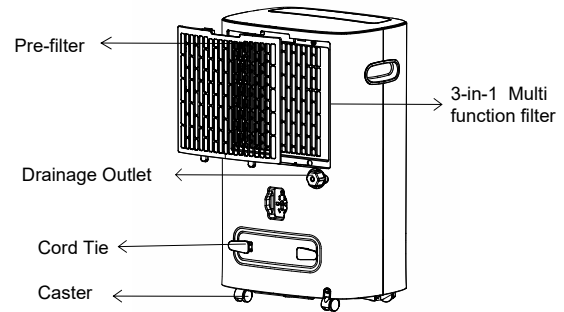

Water Tank

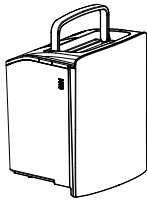

Do not remove the Float from the Water Tank, or otherwise the Dehumidifier cannot detect the water level that may cause leakage and malfunction.

Installation setting

Keep enough space around the Dehumidifier to ensure effective operation. Please place the Unit according to the specifications shown in the diagram to the right. Insufficient space may impact on the performance of the Dehumidifier.

Caution

- Drain the Water Tank before use.
- Minimise the frequency of opening and closing doors and windows to save energy.
- Keep enough space around the Dehumidifier. Allow at least 50cm of air space above the Unit and at least 20 cm on four sides, as shown in the diagram.
- Operating noise: It is recommended to place the Dehumidifier on top of a mat or rubber slab to reduce vibration and noise, which may also prevent creating carpet depression or dents on wood flooring.

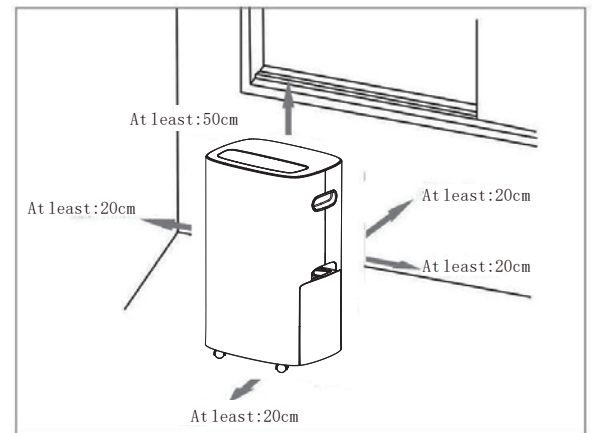

Component Parts (Cont.)

Control panel

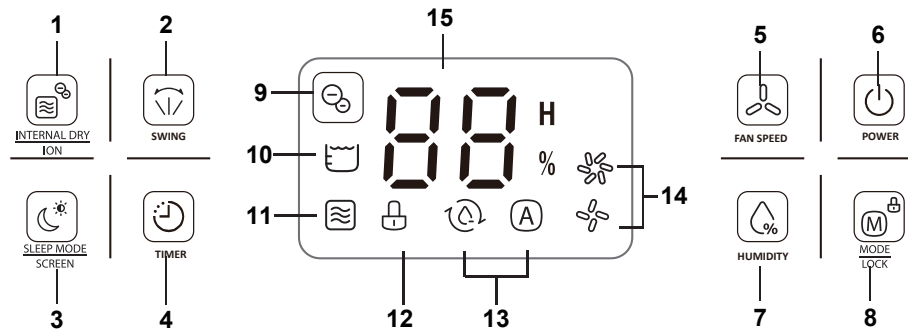

Key Function

1. Functional Key: Internal drying function of the body; Negative ion function;
2. Swing key: Swing function of louver;
3. Sleep key: Sleep key: Sleep mode;
4. Timer key: Timing setup;
5. Fan speed key: Fan speed adjustment;
6. Power key: Turn on/off the machine;
7. Humidity adjustment key: Humidity set between 30% and 80% in circle;
8. Mode key: Dehumidifying and dry cloth function.

Display icon

9. Negative ion icon: the icon indicate for the operation of anion function, long press the negative ion button for 3 seconds, the icon will display.
10. Full water tank icon: this icon will be displayed when the water tank is full.
11. Drying icon inside the machine: this icon indicating the operation of drying function inside the machine, press the negative ion key to activate the function.
12. Child lock icon: this icon indicating the on/off of child lock function, long press the mode button for 3 seconds to display the icon;
13. Mode icon: these icons are indicate the operating mode correspondingly, the left icon is the laundry mode icon; the right icon is the auto mode icon
14. Fan speed icon: these icons indicate the operating fan speed; the upper icon is the high fan speed option; the lower icon is the low fan speed option;
15. Digital display: indicating the ambient humidity of standby and operating status respectively; setting the humidity level in auto mode; timer setting in timing mode.

Function Options

• Please refer to P11-13 (How to Operate) for detailed instruction.

Situation	Operation Mode
<p>To dehumidify</p> <p>To remove moisture and suppress the mildew growth on the ceiling and wall.</p>	<p>To keep the optimal humidity of a space</p> <ul style="list-style-type: none"> • Automatic Mode <p>In this Mode, the Unit operates intermittently. When the current humidity is higher than the preset humidity level by 5%, the compressor turns on and the Fan starts operating with the preset Fan Speed. When the current humidity is lower than the preset humidity level by 5%, the compressor stops operating, the fan stops running. When the current humidity is within the $\pm 5\%$ range of the preset humidity level, the Unit operates at the default operation mode with the humidity level preset at 50%.</p> <ul style="list-style-type: none"> • Laundry Drying Mode <p>In this Mode, regardless of the current humidity, the compressor turns on and the Fan operates at High Speed, with the Fan Speed adjustable.</p>

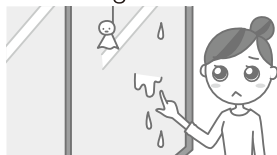

To dry laundry

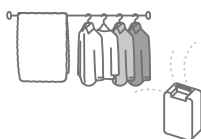

To dry laundry with warm dry air

- Select high or low fan speed.
- Place the laundry at the spot where the warm dry air can reach to.

Caution

- During normal operation, the Dehumidifier may make different operating noises and heat up the bottom of the Unit.

The Unit makes a cracking popping noise from the cooling system at the back when it starts operating but it quiets down after warm-up.

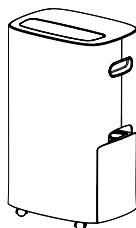

The Unit makes a buzzing noise when the compressor (placed at the bottom of the Unit) turns on.

The bottom part of the Unit heats up as a result of the operation of the compressor.

Internal Dry Operation

The Internal Dry Operation can dry the inside of the Unit to suppress mildew growth. This function can be activated by pressing the Internal Dry Operation function key, and deactivated by pressing the same function key again.

Drying Laundry

Proper use of the Laundry Drying Mode

- Hang and space the laundry evenly
Pointing airflow from the Unit directly at the laundry and spacing the laundry evenly could shorten the laundry drying time.
- Position of the Dehumidifier
Shifting the position of the Dehumidifier and the laundry to shorten the drying time.
- Sort the laundry according to fabric type and thickness and position the laundry accordingly.
 - Heavyweight clothing takes a long time to dry so it should face the Air Outlet directly.
 - Denim jeans and dress takes a short time to dry that it could be placed further away from the Unit.
 - Lightweight clothing takes a short time to dry that it could be placed further away from the Unit.
- Take down the laundry as soon as it is dry
On humid or rainy days, laundry should be taken down as soon as it is dry, or otherwise it will absorb moisture from the air.

Tips

- The drying time will be longer in the following situations:
 - The laundry is in high volume
 - The laundry is heavy weight cloth
 - The room temperature is low
 - Insufficient space between the laundry
 - The room for drying laundry is big

Preparation and Confirmation

Water Tank Insertion

The Unit cannot operate if the Water Tank is not properly inserted or when it is full of water.

Taking out the Tank

Put your hand into the clasp above the side tank, and gently remove the tank.

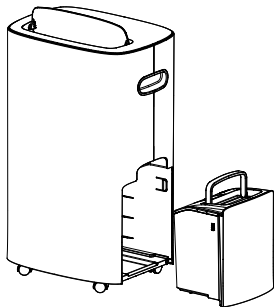

Inserting the Tank

- ① Put the water tank cover on, and rotate the water tank handle down.
 - ② Gently put the water tank back to the correct position, and then restart the dehumidifier
- Please tidy the handle of the water tank and gently put the water tank back in place.

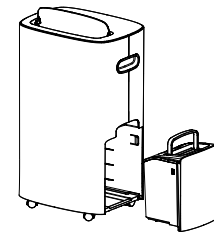

Caution

- Confirm that the water tank cover and water tank drain are installed, otherwise water may leak.
- When the water tank is full, please empty the water in the tank.

Filter installation method

Install the 3-in-1 Multi function filter onto the filter frame, so that the intake air can be purified.

- Remove the filter frame behind the fuselage.
- Install the 3-in-1 Multi function filter into the filter frame.
- Put the filter frame back into the machine.

Note: The dehumidification performance will be decreased after adding the filter. You can remove the 3-in-1 Multi function filter during dehumidification to achieve the best dehumidification result.

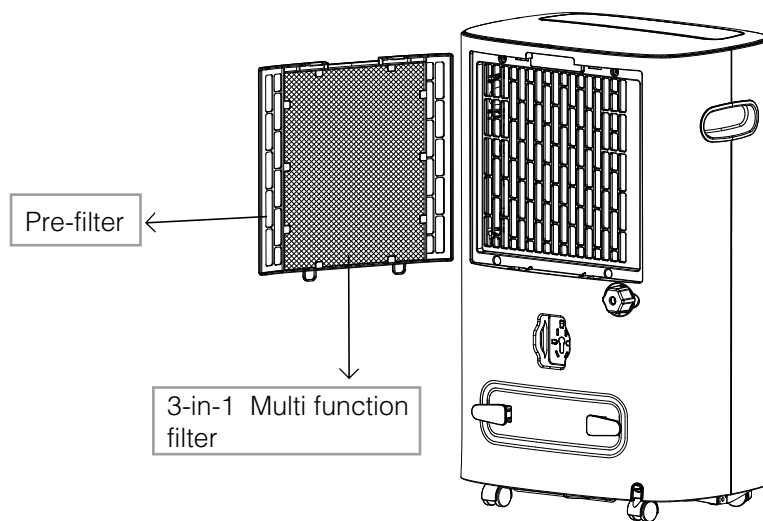

How to Operate (Dehumidification and Internal Dry Operation)



Warning



Prohibited

Power cord cannot be damaged, bent, stretched, tied up or trapped under heavy objects, got caught under the casters or doors, modified, or heated up. It may result in electric shock, fire, heat generation, short circuit and ignition.

1 Plug In

- Alarm beeps once.

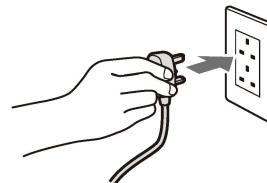

2 Power Switch

- Press the switch to turn on or off the Dehumidifier.

3 Modes of Operation

- Choose between Automatic Mode and Laundry Drying Mode when turning on the Dehumidifier. The corresponding indicator of the Mode chosen will illuminate.
- The Child Lock function can be activated and deactivated by pressing and holding the switch for 3 seconds.

4 Humidity Selector

- The humidity level can be set in Automatic Mode, with increment or decrement by 5% between 30-80%.

How to Operate (Cont.)

5 Fan Speed

- Fan Speed can be adjusted in both Automatic Mode and Laundry Drying Mode between High airflow mode and Low airflow mode.
-

6 Swing

- Press this button to turn on/off the swing function.
-

7 Function

- Press Function button to activate the internal dry function.
 - Press Function button and hold for 3 seconds to activate Negative Ions Operation.
 - Press Function button and hold for 3 seconds to deactivate Negative Ions Operation.
-

8 Sleep

- Press and hold this button for 3 seconds to turn on/off the display.
-

9 Timer

- Press Timer button to set up Timer for switching the Unit on and off at specific times, within a 24 hour period.
- The Unit can be set to turn on and off at specific times during the operation of the unit.
- The Unit can be set to turn on at specific time when it is not operating.
- Timer setting can be cancelled by pressing the Timer button when asked to confirm the Timer setting. The On and Off Timer can be set within a 24 hour period, with 1 hour as the unit of time.

How to Operate

How to empty the Water Tank

Moisture in the air is condensed and drops into the Water Tank.

- When the Water Tank is full, the Dehumidifier stops operating, illuminates the 'Full' indicator and beeps to alert.

1 Pull out the Water Tank slowly to prevent splash.

Caution

Pulling out the Water Tank

- Alarm set off
- Water residual around the Drainage Outlet may drip down that have to be wiped away.

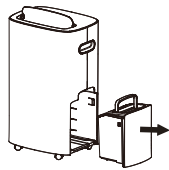

2 Grab the Handle of the Water Tank to lift it slowly.

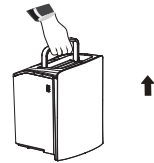

3 Tilt the Water Tank to slowly release the water.

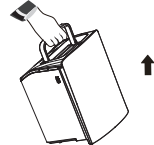

4 Insert the Water Tank back into the Unit.

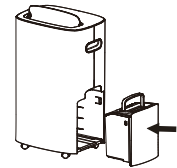

Please go to P13 for Continuous Drainage

Moving the Dehumidifier



Caution



Prohibited

Stop moving the Unit when the Casters are stuck by flooring or carpet, and go sideways.

- Lift the Unit up to go over bumpy areas and where the casters get stuck easily.

1 Switch off the Unit, unplug it and remove water from the Water Tank.

2 Coil up the power cord and transport the Unit by grasping the Handle firmly.

- Be cautious to keep the power cord from getting caught in the casters. Lift the Unit up by holding the Handle firmly to go over stairs or change direction of movement.

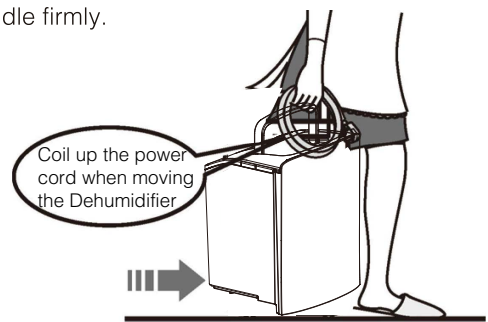

Tips

- Placing the Dehumidifier in the same spot for a long period of time may leave depression on carpet or dents on wood flooring.

Continuous Drainage

Caution



A hose has to be properly installed for Continuous Drainage operation, or it may result in dampening the surrounding objects, electric shock, electric leakage or fire.

Tips

- Check to make sure the hose is free of bends, and is not placed hole-side up.



Do not drain water continuously if the ambient temperature of the Dehumidifier and drain hose is below 0°C. Water inside the Unit and hose may freeze that may wet the surrounding objects when it thaws, and result in electric shock, Prohibited electric leakage and fire. Water Tank may consequently break and leak.

If a drain is available, the Dehumidifier can continuously drain water by installing a hose. This would enable the Unit to operate for a long period of time without the need to empty the Water Tank.

Specification of the drain hose (Plastic hose readily available in the market)

Length: The length of the drain hose is suggested to be under 0.6 m. The end of the hose is placed below the Drainage Outlet by a minimum of 10 cm. Keep the hose free from clog to ensure proper drainage.
Internal Diameter: Internal and external diameter of the hose are 9 mm and 13 mm respectively.

Caution

- Do not use expandable hose, as the hose may not be drained completely.

Stop the Dehumidifier before taking the following steps, and unplug it from the power socket.

1

Remove the Lid and valve of the Drainage Outlet from the back of the Unit, and insert the 9 mm hose onto the Drainage Outlet.

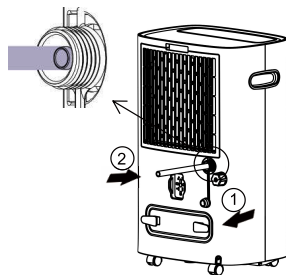

2

Remove the Lid and valve of the Drainage Outlet from the back of the Unit, and insert the screw type garden tube onto the screw type Drainage Outlet.

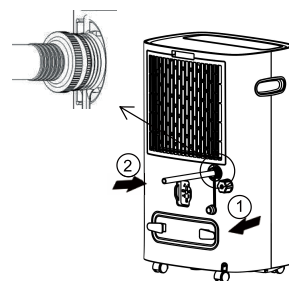

Caution

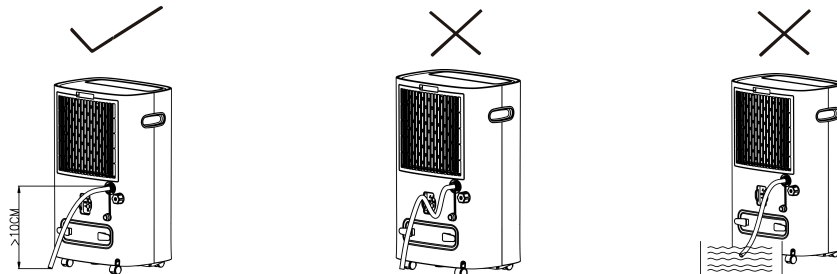

This Dehumidifier can continuously drain water by attaching a drain hose (with an internal diameter of 9 mm) onto the Drainage Outlet, saving the trouble of emptying the Water Tank. It is also possible to attach a screw type garden tube of an external diameter of 1 1/16 inch (1.0625 inch or 26.98 cm) and a screw pitch of 11.5 TPI.

Maintenance Tips



Warning



No Wet Hand

Do not plug in or unplug the Dehumidifier with wet hand. Doing so could result in electric shock.



Caution



Unplugging

Turn off the Unit and unplug the power cord before cleaning it to prevent electric shock.



Prohibited

Do not remove the Float from the Water Tank. Doing so could result in inoperability, leakage, dampening surrounding objects, electric shock, and electric leakage.

Main Body

Use soft and slightly damp cloth to wipe the Unit.

- Wipe dust off the Power Plug regularly.
- Remove stubborn dirt with soft cloth and neutral kitchen detergent.
- Clean Control Panel only with a dry cloth, and use no water.
- Do not use gasoline, thinners, alcohol, cleansing powder, or brush to prevent deforming or scratching the Unit.

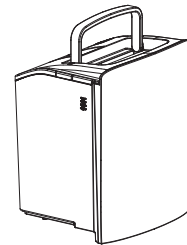

Water Tank

1

Pull out the Water Tank from the Unit.

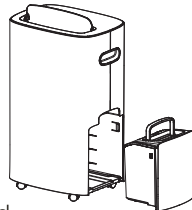

2

Remove the Water Tank Lid.

- Lift the Lid to open.

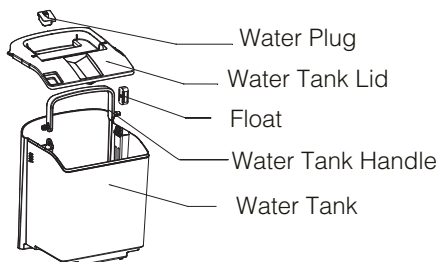

3

Clean the interior and the Lid of the Tank.

- Do not brush the Tank to prevent scratches.

4

Wipe dry the exterior of the Water Tank, put the Lid back on and insert the Water Tank into the Unit. Press down the Water Tank Handle and Lid to ensure proper installation.

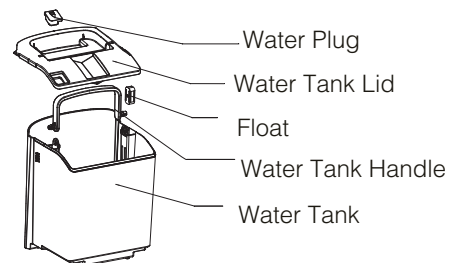

5

Insert the Water Tank back into the Unit.

- Hold the Water Tank horizontally and push it inside gently to install the Tank.

Maintenance notes (continued)

3-in-1 Multi function filter (once every 2 weeks)

- 1** The dirt of the filter can be cleaned by a vacuum cleaner
 - Slow down the suction power of the vacuum cleaner.
- 2** Remove the filter frame and take out the 3-in-1 Multi function filter
- 3** Use a vacuum cleaner to clean up the dust on the 3-in-1 Multi function filter and then wash it with water.
- 4** Wipe dry water with a towel and dry it in a well-ventilated place.
 - Install after fully drying.

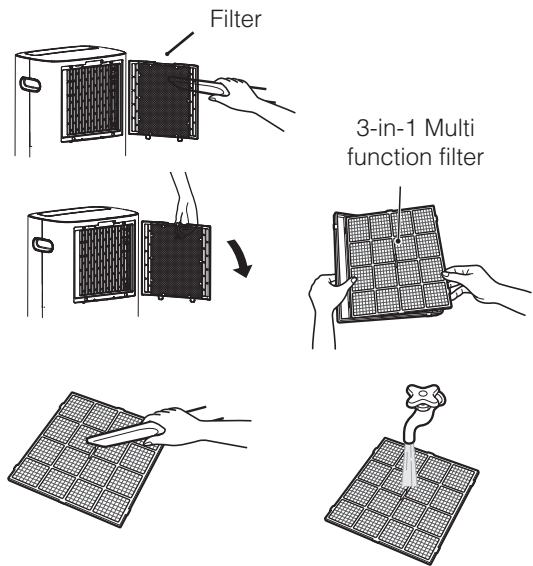

Prohibited items for 3-in-1 Multi function filter:

- a. Do not use water other than tap water for dry cleaning
- b. Do not rub the filter
- c. Can not be heated and dried
- d. Don't dry it under direct sunlight
- e. Do not apply physical pressure when dry

Product Model	Filter
	Item No
RAD-Y200H、RAD-Y250H、RAD-Y300H	41226233

Operation and Performance

Dehumidifying capacity

Dehumidifying capacity (Operation at High Fan Speed)

- Operating the Dehumidifier under the conditions set out below, the dehumidifying capacity is the amount of moisture removed per day (24 hours): High Fan Speed Operation at a room temperature of 26.7°C, indoor humidity of 60%, with no preset humidity level, and the Louver fully open. Operating with other settings and different Louver swing angle would diminish the dehumidifying capacity.

The correlation among room temperature, humidity and dehumidifying capacity

- Dehumidifying capacity at constant room temperature
The amount of dehumidifying increases with increasing humidity level and vice versa. Eg. Humidity level at 60%.
- When the Unit operates at the preset Humidity Level, it stops Dehumidifying The fan stops running. The amount of moisture removed may be small in such a situation but this is not a malfunction.
- When the machine is below the set humidity and the operation mode is [Set Humidity], it will automatically stop the dehumidification operation and the fan will stop running. Although the dehumidification volume will decrease at this time, it is not abnormal.

How does a dehumidifier work?

- ① The Unit draws moist air from the environment and cools it with evaporator.
- ② As moist air passes through the evaporator coils, moisture freezes and transforms into water droplet that drips down into the Water Tank.

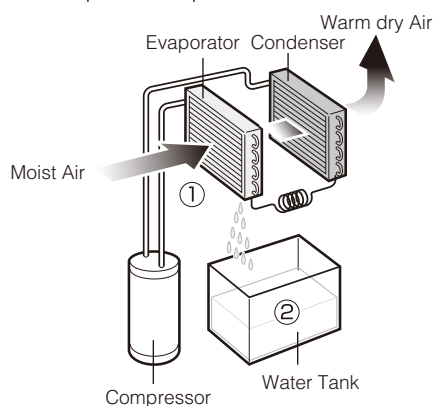

Indoor air passes through the evaporator coils and condenses on the cold coil into water droplets.

Defrost cycle during operation

- When the room temperature drops below 16°C, the Dehumidifier may frost. The Defrosting cycle will be activated during Dehumidifying Operation every 38 minutes (takes about 8 minutes) by switching to Fan Operation, to ensure proper operation of the Unit.
- Display indicates “P1” during Defrosting Operation.
- Do not unplug the power cord to force abort the Defrosting Operation.

Rise of room temperature during operation

- The Dehumidifier does not have a cooler function.
- The Unit generates heat during operation that the room temperature may rise by 1°C -4°C.

Operating noise

- Do not unplug the power cord to force abort the Defrosting Operation.
- The noise of the movement of the refrigerant is rather loud at start-up but it quiets down after warm-up.

Troubleshooting

- Please check the following items of the Dehumidifier before calling for service.

Symptoms and remedies

1. The remedies that could resolve the symptoms listed below.

Symptom	Possible Cause	Remedy
The Unit does not operate	Is the power cord properly inserted?	Plug the power cord fully into the power socket.
	Is the Water Tank full? (Water Tank is full of water or it is not properly inserted)	Empty the Water Tank and insert it back into the Unit.
	Is the ambient temperature too low or too high?	It is recommended to operate the Dehumidifier between an ambient temperature range of 5-32°C.
Poor dehumidification results	Is the temperature or humidity of the room too low?	Low humidity reduces dehumidifying effectiveness.
	Is the Air Outlet or Air Intake clogged?	Remove the items blocking the Air Outlet and Air Intake.
No air comes out	Is the Air Intake blocked?	Clear the items blocking the Air Intake.
The Unit makes abnormal operating noises	Is the Unit placed on a slope or uneven surface that causes it to tilt or wobble?	Place the Unit on a stable and leveled surface.
	Is the Air Intake blocked?	Clear the items blocking the Air Intake.
	The sound of flowing water	This is caused by the flow of refrigerant inside the Unit.
Water leakage	The drain hose is loosely attached	Securely insert the drain hose.
	The Drainage system is blocked	Unclog the hose.
Frosted up	Low ambient temperature causing the Unit to activate the defrost operation.	This is not a malfunction that defrosting operation could be activated by the Drying Inside Operation.

2. Error message code description

Code	Description
FL	Water Tank Full alarm
E1	Coil Sensor failure
E2	Ambient Temperature Sensor failure
P1	Defrosting Operation activated
CL	Drying Inside Operation activated
LC	Child Lock Mode activated

Specifications

1. Product Parameters

Model		RAD-Y200H	RAD-Y250H	RAD-Y300H
Power Supply		220V ~ 50Hz		
Dehumidification Capacity (Litre per day)	26.7°C 60%	12	14.9	18
	30°C 80%	21	27	30
Power Consumption (W)	26.7°C 60%	215	269	298
	30°C 80%	265	319	358
Water Tank Capacity (L)		4.0		
Overflow protection capacity (L)		3.7		
Weight (kg)		14.5	14.5	14.5
Dimensions (mm) (W x D x H)		350×260×560		
Operating temperature range		5°C~32°C		

The dehumidification performance will be decreased after adding the 3-in-1 Multi function filter.

2. Fuse Parameters

Voltage: 250 VAC

Current: 3.15A



Disposal:

Please do not dispose of this Unit along with other unclassified garbage. This Unit should be placed separately for special usage.

All data are given for reference only. Please note that technical upgrade may cause the product function to undergo changes without prior notice.