



使用說明書

電風扇
F-ALB60HK(B)

TOSHIBA

小心

仔細閱讀安全操作規則和說明。

警告

1. 如果電源線損壞，必須由製造商或其服務代理商或具有類似資格的人員更換，以避免危險。
2. 8歲以上的兒童以及身體、感官或精神上有障礙的人，或缺乏經驗和知識的人員可以使用本電器，前提是他們已獲得有關安全使用本電器的監督或指導，並瞭解相關的危險。兒童不得玩耍本產品。兒童不得在沒有監督的情況下進行清潔和維護。



3. **正確處置廢棄設備！**

此標記表示不得將本產品與其他生活垃圾一起處置。為了防止不受控制的廢物處理對環境或人類健康可能造成的危害，請將廢棄設備移交到指定回收點對其進行處理，以便回收廢棄的電子電機設備，促進物質資源的可持續再利用。要退回舊設備，請使用回收系統或與產品零售商聯繫，以安全回收利用此產品。

4. 僅限室內使用。
5. 在不使用設備時以及在清潔之前，請從插座上拔下電源插頭。
6. 為避免觸電危險，請勿將設備、電源線或插頭浸入水中或其他液體中。

產品簡介

■ 各部件名稱

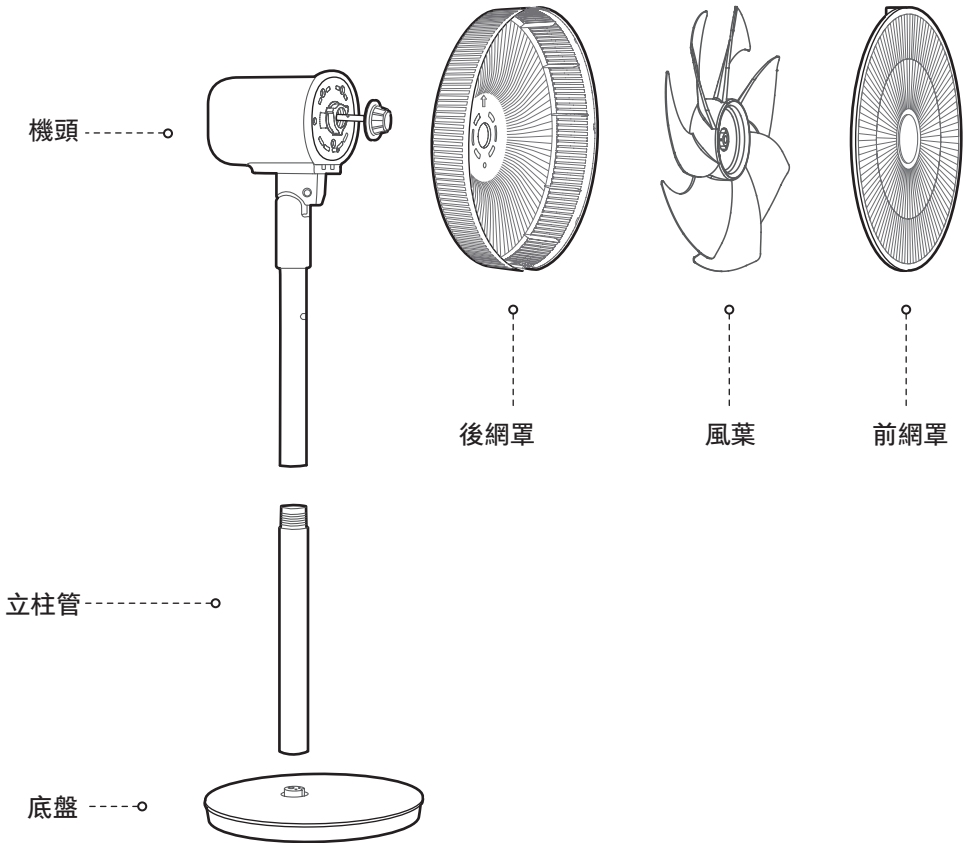

■ 控制面板

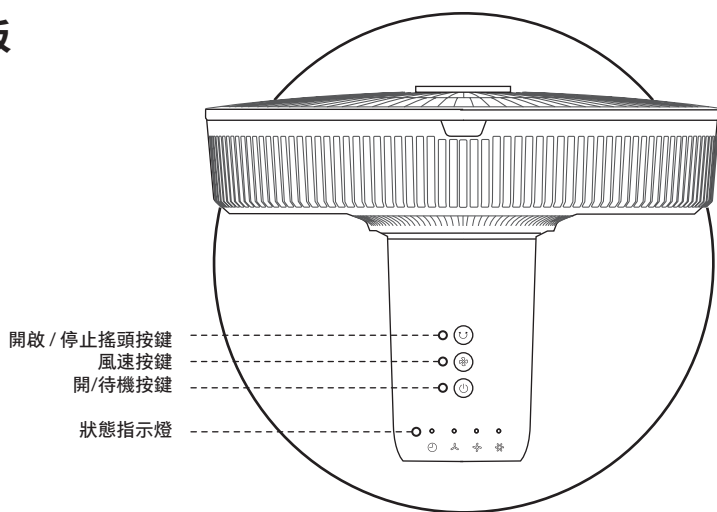

安裝說明

■ 安裝準備

安裝前請先從電機前殼上，順時針方向取出風葉索母，再逆時針方向取出網罩索母。

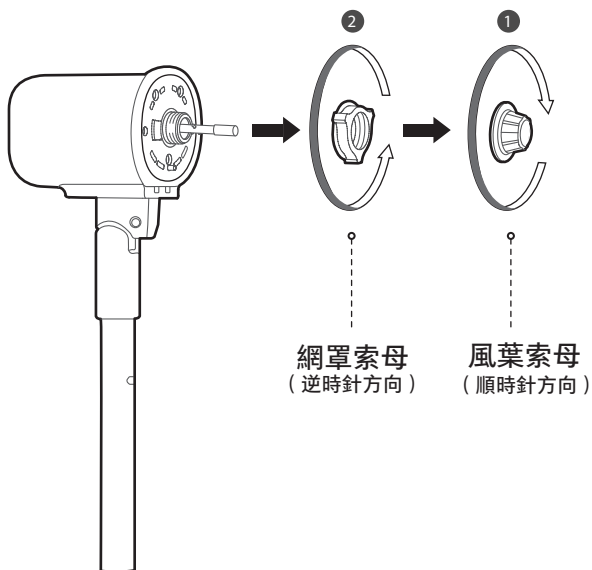

■ 安裝步驟

底盤安裝

按圖示方向將立柱管和底盤插口對位，再將立柱管插入底盤插口並卡穩；

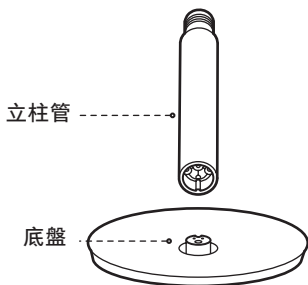

將螺栓插入底盤底部的孔位，擰緊螺栓固定立柱與底盤。

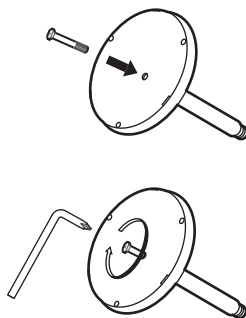

立柱管安裝

先將機身與立柱管的孔位對準，然後旋轉進去固定，完成立柱管的安裝，注意務必旋轉到位！

上立柱管的箭頭標識要在下立柱管的標識範圍內。

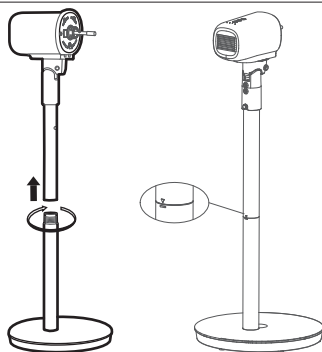

後網罩安裝

按圖示方向將風扇後網罩按箭頭方向朝上，圓孔與電機前殼上的凸點對位；

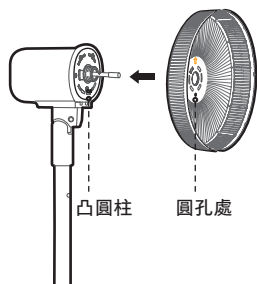

在電機頭部掛上後網罩後，順時針方向旋轉網罩索母，鎖定後網罩。

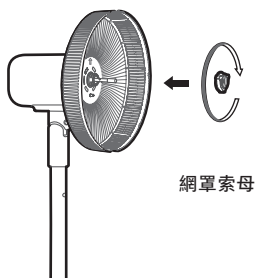

風葉安裝

將風葉和電機軸對位並穿上，風葉上有警示貼的一面朝外；逆時針方向旋轉風葉索母，將風葉鎖定。

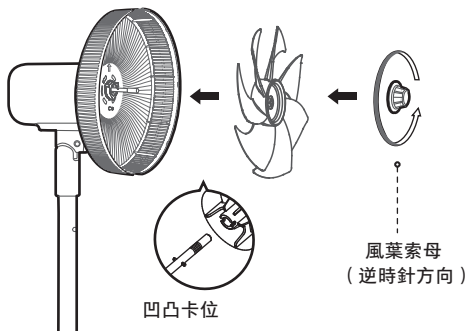

前網罩安裝

先找好前、後網罩卡扣位，將前網罩卡穩後網罩卡扣；

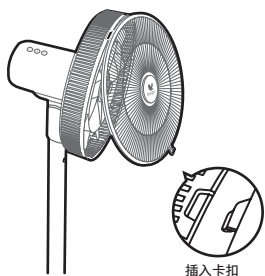

雙手按順序按壓網罩，聽到“啲”一聲，安裝到位；

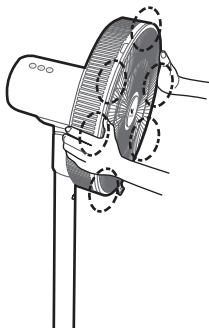

再將前網罩底部網扣卡穩，將網罩螺絲插入網扣孔位，使用螺絲刀擰緊固定。
注：1. 網罩螺絲固定在後網罩卡扣處，用戶需擰下螺絲再安裝。
2. 務必裝上網罩運行。

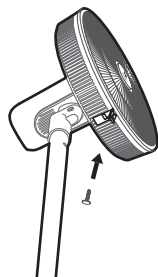

通電使用

安裝完成後，接入電源，聽到“滴”一聲後，風扇通電成功。

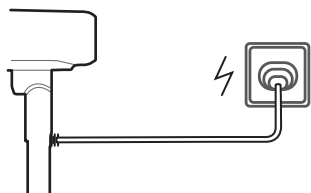

使用說明

機頭面板

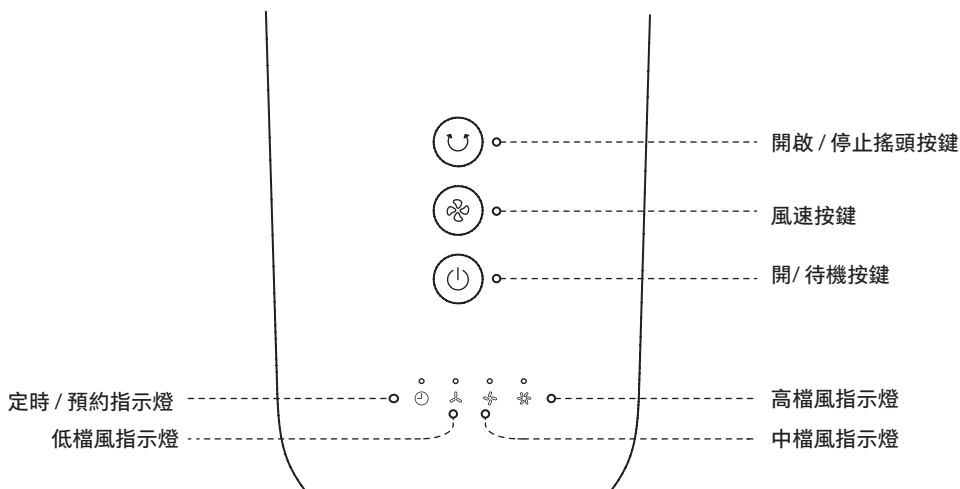

機頭按鍵說明

| 圖示 | 功能說明 |
|----|--------------------|
| | 開 / 待機 |
| | 切換正常風風檔，按低→中→高→低循環 |
| | 開啟 / 停止搖頭送風 |

指示燈說明

| 圖示 | 功能說明 |
|----|----------------|
| | 指示定時 / 預約狀態 |
| | 正常風低檔，1檔 |
| | 正常風中檔，2檔 |
| | 正常風高檔，3檔；強勁風模式 |

注：①定時開機 / 預約開機設定1小時，定時 / 預約指示燈亮；設定2小時，定時 / 預約指示燈和低檔風指示燈亮；設定3小時，定時 / 預約指示燈、低檔風指示燈和中檔風指示燈亮；設定4小時，4個指示燈均亮。

②為減少光線的干擾，機器具備熄屏功能，60秒內如無操作，所有指示燈會熄滅。此時風扇在無顯示下運行或停止，屬正常情況，不是故障。

■ 遙控器面板

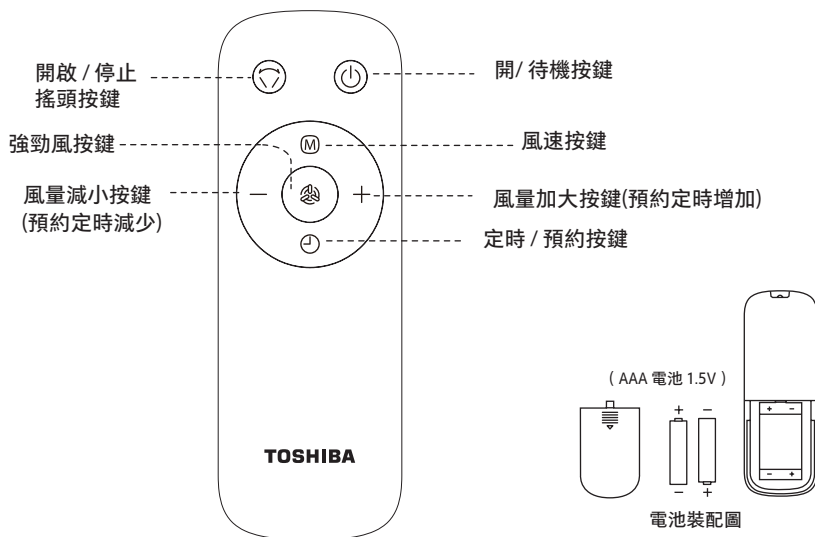

遙控器使用範圍
遙控器在產品正面5米內，左右角度在30度範圍內正常使用。

請使用型號為"AAA"的錳電池或鹼性電池，不要使用不可回收電池。

遙控器按鍵說明

| 圖示 | 功能說明 |
|----|--|
| | 開 / 待機 |
| | 開啟 / 停止搖頭送風 |
| | 切換正常風風檔，按低→中→高→低循環 |
| | 切換正常風風檔，風速檔位遞增 切換時間，定時 / 預約時間遞減 |
| | 切換正常風風檔，風速檔位遞減 切換時間，定時 / 預約時間遞減 |
| | 開啟 / 關閉定時關機，1小時後關機 開啟 / 關閉預約開機，1小時後開機 先按定時鍵，5s內按“+，-”鍵則調整增加或減少定時，共4小時定時（1，2，3，4） |
| | 開啟 / 關閉強勁風 |

保養說明

風扇幾乎不需要保養。不要試圖自己修理。如果需要維修，請把它交給有資質的維修人員。

1. 在清潔和組裝之前，必須拔下風扇的電源線。
2. 為確保電機有充分的通風，請確保電機背面的通風孔沒有灰塵。請勿拆卸風扇以清除灰塵。
3. 請用軟布蘸中性清潔劑擦拭外部部件。
4. 請勿使用任何研磨性清潔劑或溶劑，以免刮傷表面。請勿使用以下任何一種清潔劑：汽油、稀釋劑。
5. 請勿讓水或任何其他液體進入電機外殼或內部零件。

清潔

1. 清潔前，請務必拔下電源插頭。
2. 塑膠部件應使用蘸有中性肥皂液的軟布清潔。用乾布徹底清除肥皂膜。

OWNER'S MANUAL

Electric Fan
F-ALB60HK(B)

TOSHIBA



CAUTION

Read Rules for Safe Operation and Instructions Carefully.

WARNING

1. If the supply cord is damaged, it must be replaced by manufacturer, its service agent or a similarly qualified person in order to avoid a hazard.
2. This appliance can be used by children aged from 8 years and above and persons with reduced physical, sensory or mental capabilities or lack of experience and knowledge if they have been given supervision or instruction concerning use of the appliance in a safe way and understand the hazards involved. Children shall not play with the appliance. Cleaning and user maintenance shall not be made by children without supervision.



3.  Correct Disposal of this product

This marking indicates that this product should not be disposed with other household wastes throughout the EU. To prevent possible harm to the environment or human health from uncontrolled waste disposal, recycle it responsibly to promote the sustainable reuse of material resources. To return your used device, please use the return and collection systems or contact the retailer where the product was purchased. They can take this product for environmental safe recycling. The packaging material is recyclable. Dispose of the packaging in an environmentally friendly manner and make it available for the recyclable material collection-service.

4. Indoor and household use only.
5. When the appliance is not in use and before cleaning, unplug the appliance from the outlet.
6. To protect against the risk of electrical shock, do not disassemble the fan and do not immerse the unit, cord or plug in water or other liquid.

Product Introduction

■ Name of Each Component

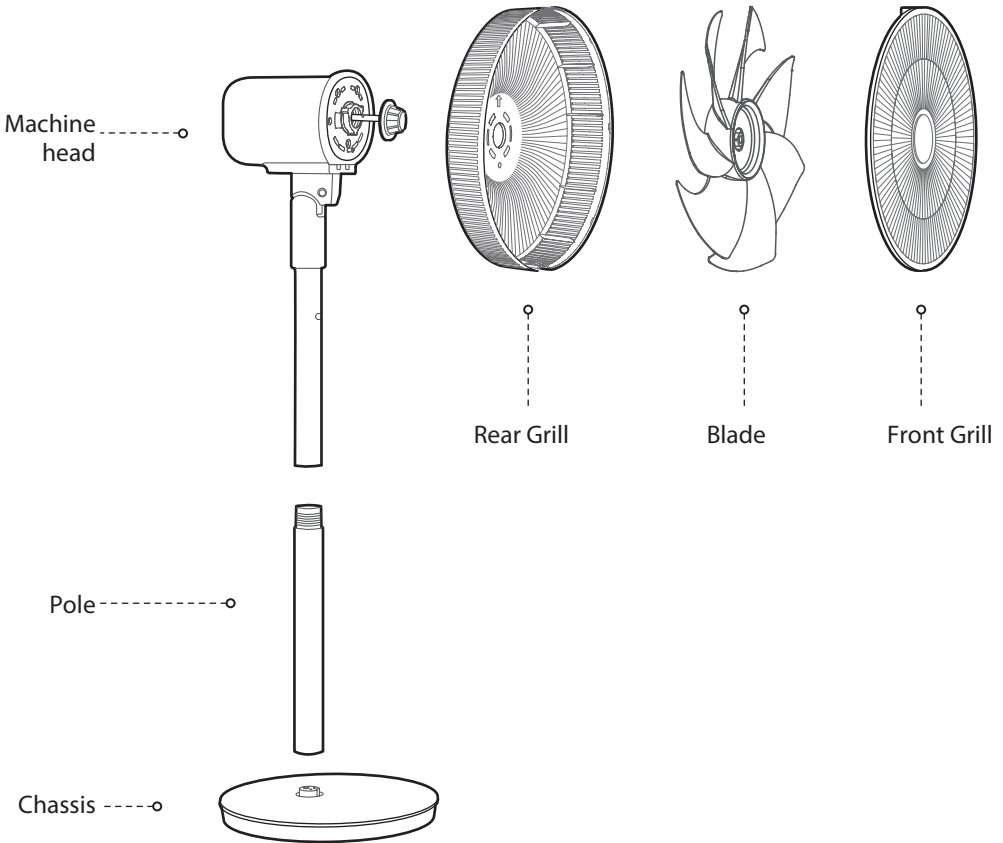

Control Panel

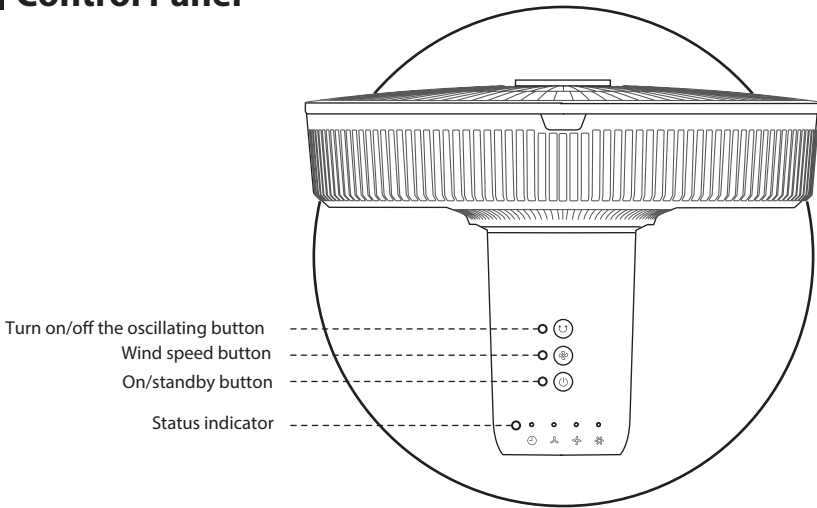

Installation Instructions

Installation preparation

Please take out the lock nut of blade from the front enclosure of the motor clockwise, and then take out the lock nut of grill counterclockwise before installing.

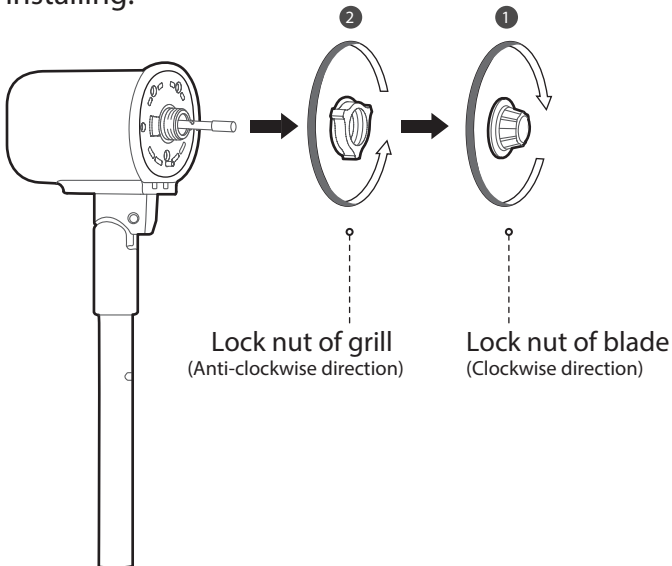

Installation Procedures

Chassis Installation

Position the pole and chassis sockets in the direction shown, insert the pole into the chassis socket and stabilize it;

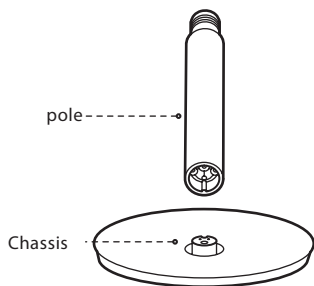

Insert the bolt into the hole at the bottom of the chassis and tighten the bolt to fix the pole and chassis.

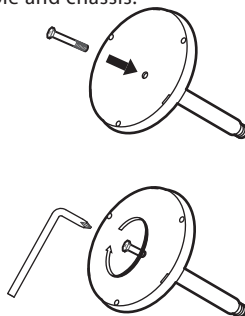

Pole Installation

First, you need to align the hole of the machine body with the pole, then rotate it in and fix it to complete the installation of the pole, be sure to rotate in place.

The arrow mark of the upper column tube is to be within the identification range of the lower column tube.

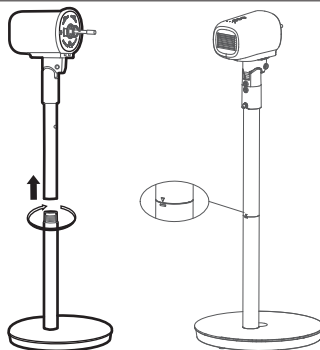

Rear Grill Installation

According to the direction shown, make the rear grill of the fan upward in the direction of the arrow, and make the round hole aligned with the salient point on the front enclosure of the motor;

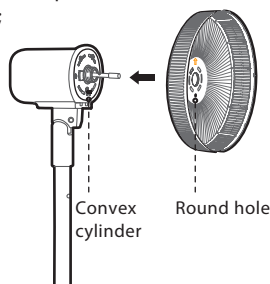

After the motor head is hung on the rear grill, rotate the plastic nut clockwise to lock the rear grill.

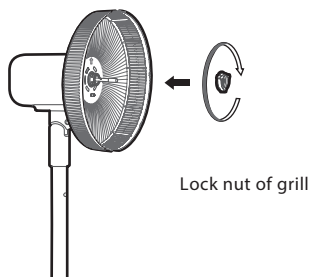

Blade Installation

Align the blade with the motor shaft and put it on, and the side with warning label of the blade faces outward; Rotate the spinner counterclockwise to lock the blade.

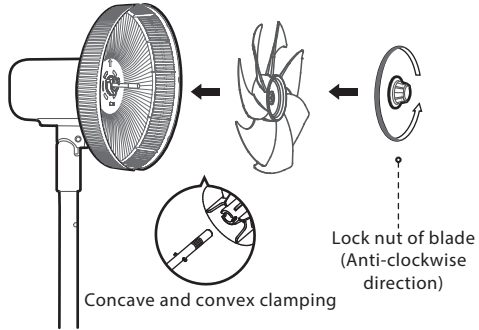

Front Grill Installation

First, find the front and rear grill clamping, and stabilize the front grill to the rear grill buckles;

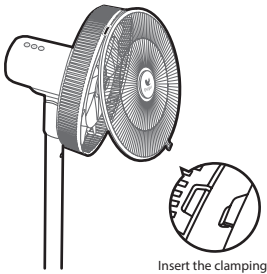

Press the mesh enclosure by both hands in sequence, and when you hear a "click", the installation is in place.

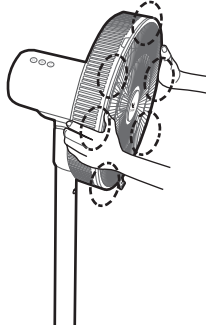

Then fasten the net buckle at the bottom of the front grill, insert the mesh enclosure screw into the hole of the net buckle, and tighten it with a screwdriver.

Note: 1. The mesh enclosure screw is fixed at the rear grill clamping, and the user needs to unscrew the screw and then install it.
2. Be sure to install the net cover when running.

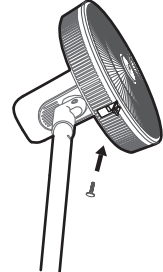

Power Up

After installation, plug on the machine. After hearing the "drop", the fan is powered on successfully.

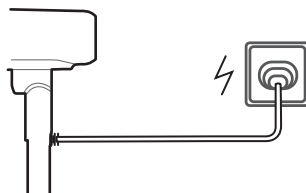

Instructions for Use

Panel of machine head

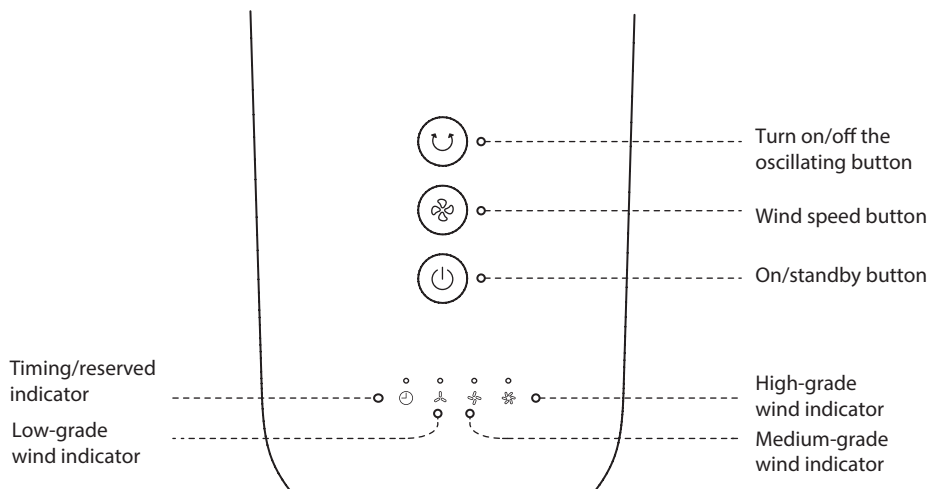

Instructions of buttons on the machine head

| Icon | Function description |
|------|--|
| | Startup/Standby |
| | Switch to the normal wind grade by pressing the low→medium→high→low to cycle |
| | Turn on/off shaking the head to supply wind |

Descriptions for the indicators

| Icon | Function description |
|------|---|
| | Indicate timing/reserved status |
| | Normal wind of low grade, grade 1 |
| | Normal wind of medium grade, grade 2 |
| | Normal wind of high grade, grade 3, Strong wind model |

Note: ① If timing turning off/on reserved is set for 1 hour, the timing/reserved indicator will be on; if it is set for 2 hours, timing/reserved indicator and low-grade wind indicator will be on; if it is set for 3 hours, timing/reserved indicator, low and medium-grade wind indicator will be on; if it is set for 4 hours, 4 indicators will be all on;

② The machine has a screen-off function in order to reduce the interference of light, which means if there is no operation within 60 seconds, all the indicators will go out. At this time, the fan runs or stops without display, which is normal and is not a malfunction.

Panel of Remote controller

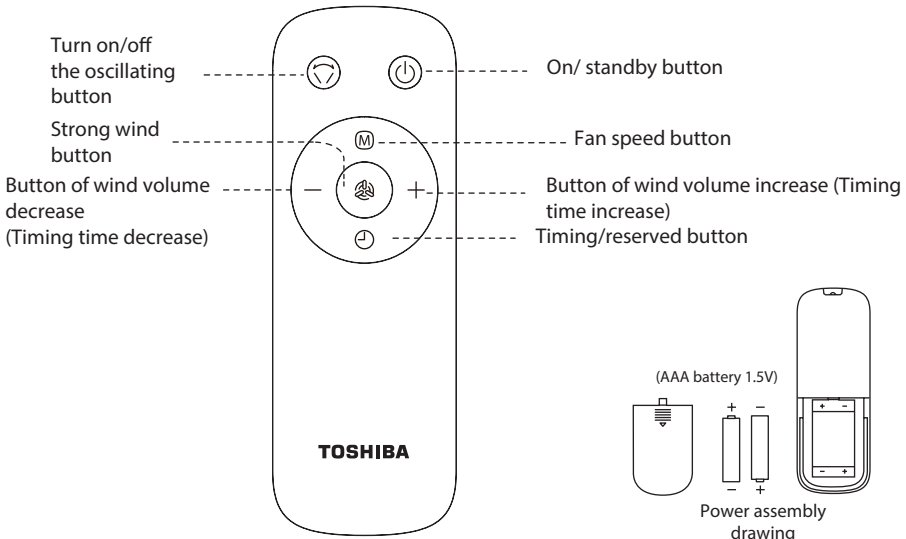

Control range of remote controller
The remote controller control can be normally used within 5 meters in front of the product and in the left and right angles of 30 degrees.

Please use a manganese or alkaline battery of type "AAA" and do not use a non-recyclable battery.

Specifications for remote controller buttons

| Icon | Function description |
|------|---|
| | Turn on/Standby |
| | Turn on/off oscillating to supply wind |
| | Switch to the normal wind grade by pressing the low→medium→high→low to cycle |
| | Switch to the normal wind grade, wind speed and grade are increasing; Switch the time, the timing/reserved time is increasing. |
| | Switch to the normal wind grade, wind speed and grade are decreasing; Switch the time, the timing/reserved time is decreasing. |
| | Turn on/off timing powering off, it will power off 1 hour later; Turn on/off reserved powering on, it will power on 1 hour later. Press the timing button first, then press the "+、-"button within 5 seconds, you can adjust the increase or decrease of the timing time, for 4 hours timing range in total(1,2,3,4). |
| | Turn on/off strong wind |

MAINTENANCE INSTRUCTION

The fan requires little maintenance. Do not try to fix it by yourself. Refer it to qualified service personnel if service is needed.

1. Before cleaning and assembling, fan must be unplugged.
2. To ensure adequate air circulation to the motor, keep vents at the rear of the motor free of dust. Do not disassemble the fan to remove dust.
3. Please wipe the exterior parts with a soft cloth soaking a mild detergent.
4. Do not use any abrasive detergent or solvents to avoid scratching the surface.
Do not use any of the following as a cleaner: gasoline, thinner.
5. Do not allow water or any other liquid into the motor housing or interior parts.

CLEANING

1. Be sure to unplug from the electrical supply source before cleaning.
2. Plastic parts should be cleaned with a soft cloth moisten with mild soap.
Thoroughly remove soap film with dry cloth.

#DetailsMatter