



使用說明書

空氣循環扇
F-DCE70HK(W)



TOSHIBA

目錄

重要安全說明.....	02
安全操作規則.....	04
零件名稱.....	05
配件清單.....	05
產品安裝.....	06
控制面板說明.....	08
遙控器按鈕說明.....	08
如何使用.....	09
自動關機功能.....	12
設定擺放位置.....	12
規格.....	13
清潔與保養.....	13
故障排除.....	13

非常感謝你選購東芝風扇。

- 為確保正確及安全使用本風扇，請在使用前仔細閱讀本說明書並充分理解其內容。
- 閱讀完本說明書後，請將其保存在易於查閱的地方。

重要安全說明

安全注意事項

請務必遵守以下指示！

本說明書提供的指示，在使用風扇時必須遵守，以防止對使用者、其他人及財產造成危險。





⚠ 注意

- 本節描述了安全事項的內容和重要性，以防止對使用者或其他人造成人身傷害或財產損失。請充分理解以下內容後閱讀內容，並務必遵守所描述的安全注意事項。
- 請勿用手操作，因為如果在運轉時用手移動風扇，將導致關機重置位置發生偏差。



⚠ 注意事項

請仔細閱讀安全操作規則和說明。

⚠ 警告

 警告	電線如有損壞，請由製造商或代理商或具類似資格的專業人士更換，以免發生危險。
 警告	只供室內使用。
 警告	請勿將裝置、電線或插頭浸泡在水中或其他液體中，以免觸電。
 警告	關閉電源並拔掉插頭，待電器冷卻後再進行清潔。

 警告	本電器不適合生理、感官或精神能力衰弱或缺乏經驗和知識的人員（包括兒童）使用，除非電器是在負責他們安全的人員監督或指導下使用。應監督兒童以確保他們不會玩弄電器。
 警告	請將電器置於兒童或體弱人士無法觸及的地方。請勿讓他們在無人看管的情況下使用本產品。
 警告	請勿在產品安裝完成前連接電源。
 警告	移除保護外殼前，請確保產品已與電源斷開連接。
 警告	請勿用濕手插拔電源插頭，以免觸電。
 警告	請避免在酸鹼性油、殺蟲劑、窗簾等物品附近使用。
 警告	只能使用配對的變壓器。切勿使用其他變壓器，以免發生危險。
 禁止	產品運作時，請勿將手指或尖銳物品伸入網罩。

 禁止	禁止在有易墜落懸掛物、易受撞擊或放置不穩定的地方使用。請將產品平穩放置，切勿傾斜或翻倒。
 禁止	移動產品前請先關閉電源。
 禁止	請避免長時間在陽光直射或高濕度環境下使用。

安全操作規則

⚠ 可能導致輕微傷害或財產損失的事項。

 警告	使用前，請檢查使用的電壓與產品標示的電壓是否相同。
 警告	當你離開機器或機器不在使用時，請關閉電源並拔掉電源插頭，以避免電路故障及意外。
 警告	使用前，請檢查電源線和插頭是否損壞。若電源線損壞，必須由製造商、其維修部門或類似部門的專業人員更換，以避免危險。
 警告	請勿在窗戶附近使用風扇，因為雨水可能會導致觸電。

零件名稱

注意：

說明書中的圖片僅供參考。包裝盒內的實際產品為準。

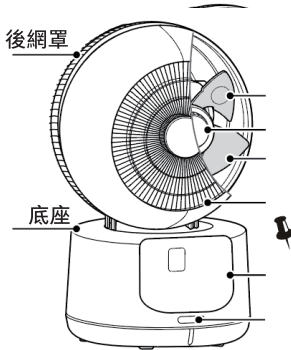

- 扇葉警告標籤
- 扇葉蓋
- 扇葉
- 前網罩
- 注意：請勿堵塞
- 控制面板
- 接收部件

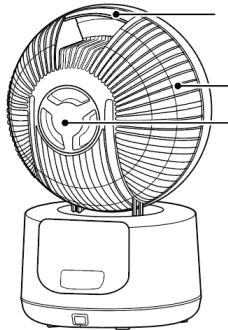

提手

後網罩

後網罩固定螺母

配件清單



遙控器 × 1



電池 × 2



使用說明書 × 1

產品安裝

安裝方法

1. 將機身背面朝向前。打開後網罩至後網罩鎖桿鬆開的狀態。用雙手握住後網罩，注意不要觸碰到機身。插入機身時，請將後網罩的孔對準機身的網罩螺母接口並進行安裝。順時針轉動網罩螺母至「Lock」位置，確保後網罩已牢固固定。

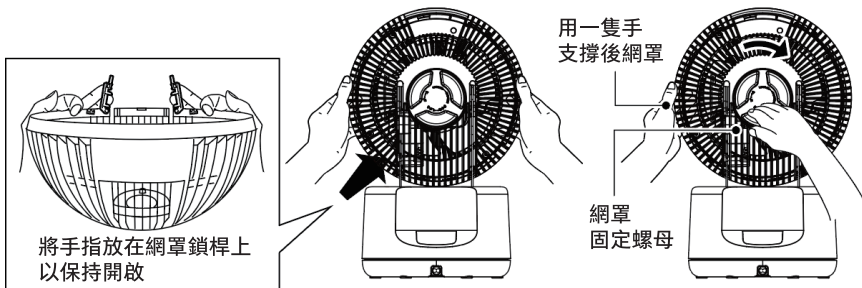

2. 將機身正面朝上。關閉後網罩鎖桿，確保後網罩已鎖定。

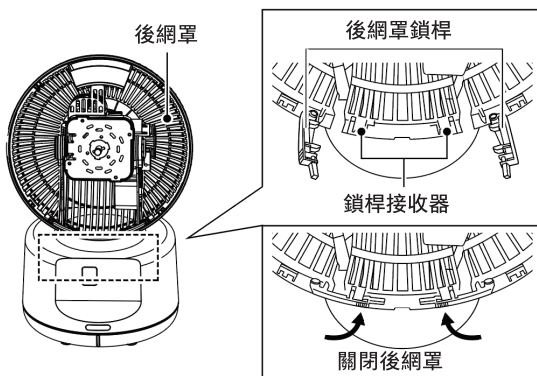

3. 將扇葉背面上的凹槽與馬達軸上的插銷對齊，並確保扇葉已穩固安裝到位。

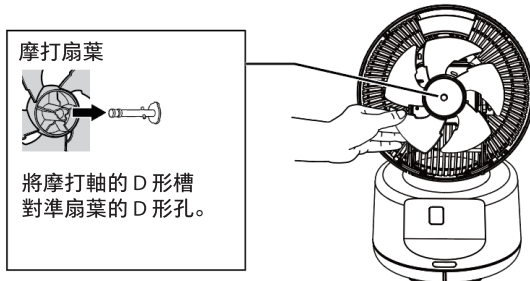

產品安裝

安裝方法

4. 將前網罩上標有「●」的記號朝上，雙手握住，並將「●」記號與後網罩上的「☐」記號對齊。順時針轉動正面網罩上標有「●」的記號，與後網罩上的「☐」記號對齊。

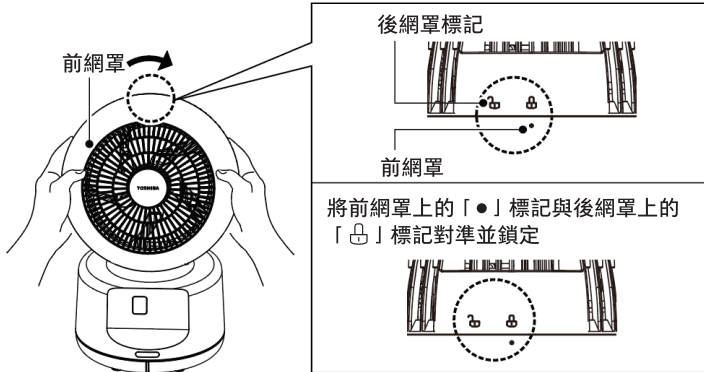

注意：

- 請確保正面網罩的「●」記號與後網罩的「☐」記號已正確對齊。
- 網罩在運轉時可能會鬆脫。
- 清潔後，請等待機身完全乾燥後再使用。

5. 最後，請使用螺絲將前後網罩在機身把手處固定。

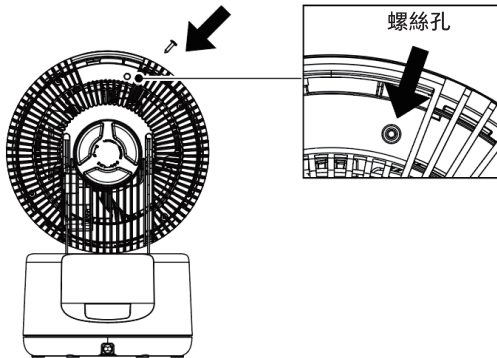

控制面板說明

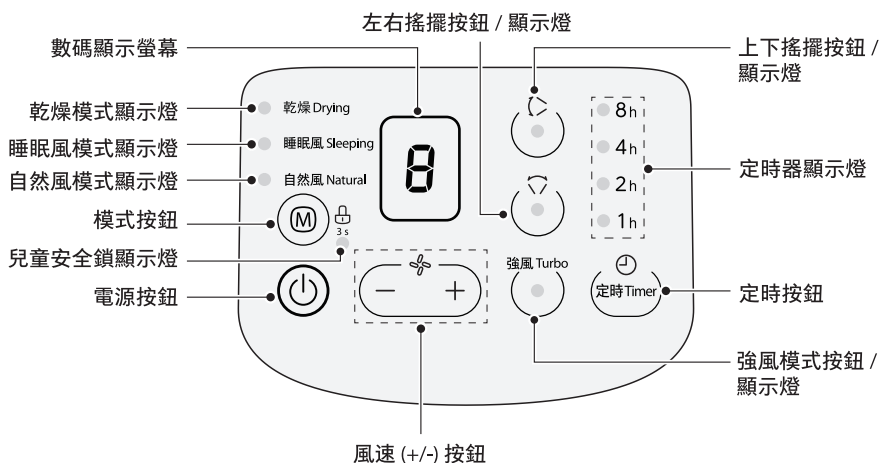

遙控器按鈕說明

注意：

- 遙控器可在產品前方 5 米範圍內，偏差角度在 30° 以內正常使用。
- 遙控器電池含有許多重金屬、酸和鹼等物質，對人體健康構成威脅；廢棄電池應分類回收。

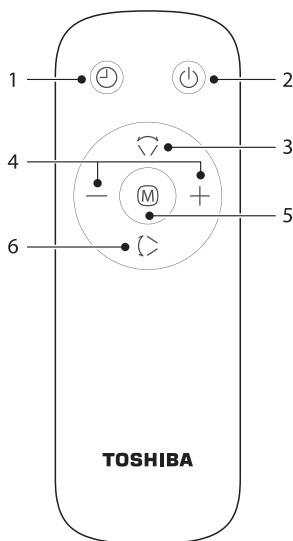

編號	按鈕	說明	功能
1		定時按鈕	• 設定關機的定時器。
2		電源 / 待機按鈕	• 開啟 / 待機按鈕。
3		左右搖擺按鈕	• 啟動或停止左右搖擺送風。
4		增加 / 減少按鈕	• 調整風速檔位。
5		模式按鈕	• 風扇運轉時，短按此按鈕可切換模式（正常模式→乾燥模式→睡眠風模式→自然風模式→強力模式循環）。
6		上下搖擺按鈕	• 啟動或停止上下搖擺送風。

遙控器按鈕說明

電池安裝

- 用手指滑開電池盒蓋。
- 插入 2 粒 AAA 電池，並確保電池放置如圖所示（圖 1）。
- 按照所示方向滑動電池盒蓋，裝回電池盒蓋（圖 1）。

圖 1

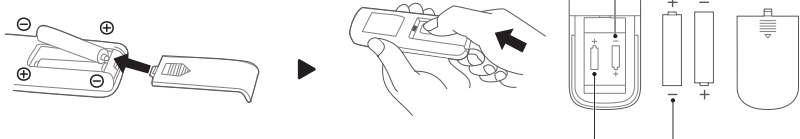

注意：

- 遙控器使用“AAA”型碳性鋅錳電池。
- 請勿使用充電電池。
- 非充電電池不得充電。
- 請以正確極性插入電池。耗盡的電池應從電器中取出並妥善處理。
- 如果長時間不使用本電器，請取出電池，電源端子不得短路。
- 請勿將遙控器電池放入回收桶，否則電池可能會爆炸或漏液。
- 請勿混用新舊電池。請勿混用鹼性、標準（碳鋅）或充電式（鎳鎘）電池。

如何使用

- 操作主機操作部分說明。你也可以使用遙控器執行相同操作。

1. 請完全插到最入。

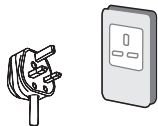

蜂鳴器會響起，所有指示燈會亮起約 1 秒。

2. 按下電源按鈕開始運轉。



風扇開始吹風。
再次按下電源按鈕停止。

(示例)
風量 1

3. 調整風量

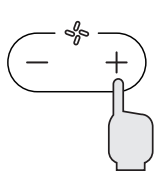

(示例)
風量 1-9

每次按下風速 (+) 按鈕，皆可將風力強度在 9 個級別間切換，相對應的風量指示燈會亮起。

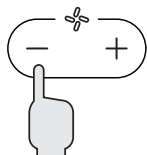
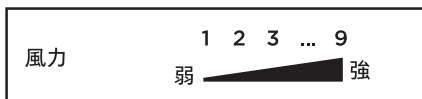

(示例)
風量 1-9

每次按下風速 (-) 按鈕，風量會降低一個級別，直到達到最低級別 1，相對應的風量

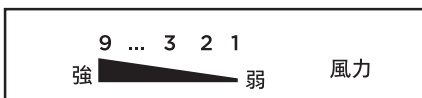

4. 上下左右擺動

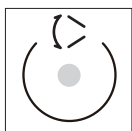

(示例)
開啟上下擺動

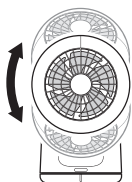

按下「」按鈕，產品會發出「嗶」聲。

「」按鈕燈會亮起，開始上下擺動運轉。

再次按下「」按鈕即可停止擺動，按鈕燈會熄滅。

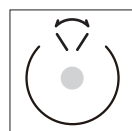

(示例)
開啟左右擺動

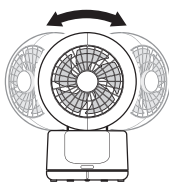

按下「」按鈕，產品會發出「嗶」聲。

「」按鈕燈會亮起，並開始左右擺動。

再次按下「」按鈕即可停止擺動，按鈕燈會熄滅。

5. 強風模式

強風 Turbo



(示例)
開啟上下和
左右擺動

按下「」按鈕，產品會發出「嗶」聲。「」按鈕燈會亮起。

在此風力模式下，風扇將以最高速度運轉，並同時啟用左右和上下擺動。在此模式下，擺動功能無法關閉。

要結束此模式，請再次按下「」按鈕，按鈕燈會熄滅。

在此模式下，數碼顯示螢幕會像跑馬燈一樣顯示。

6. 預約關機設定時間：1-15 小時

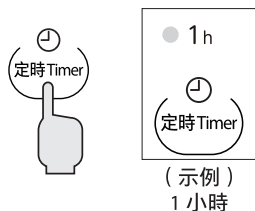

操作時按下預約關機按鈕即可設定預約關機（可設定的時間為 1-15 小時）。

對應設定時間的指示燈會亮起。

定時器的持續時間對應於定時器燈上的累積數碼顯示。

- 如要取消預約關機設定，請按下預約關機按鈕以關閉預約關機指示燈。或按下電源按鈕停止、開機及重新啟動。
- 當預約關機未開啟時，無法在關機狀態下設定功能。

7. 選擇風力模式



按下「**M**」按鈕，可在五種風力模式（正常、乾燥、睡眠、自然、強風）之間循環選擇。

<p>乾燥模式</p> <p>● 乾燥 Drying</p>	<ul style="list-style-type: none">• 「● 乾燥 Drying」燈亮起，啟動乾燥模式，同時啟用上下及左右擺動功能。• 在此模式下，上下及左右擺動按鈕的指示燈也會亮起，如有需要亦可關閉擺動功能。
<p>睡眠風模式</p> <p>● 睡眠風 Sleeping</p>	<ul style="list-style-type: none">• 「● 睡眠風 Sleeping」燈亮起，啟動睡眠風模式，同時啟用上下及左右擺動功能，如有需要亦可關閉擺動功能。• 有三種風速可供選擇。• 在此模式下，按鈕會靜音。
<p>自然風模式</p> <p>● 自然風 Natural</p>	<ul style="list-style-type: none">• 「● 自然風 Natural」燈亮起，啟動自然風模式，同時啟用上下及左右擺動功能• 並有三種風速可供選擇。• 在此模式下，上下及左右擺動按鈕的指示燈也會亮起，如有需要亦可關閉擺動功能。

8. 設定兒童鎖

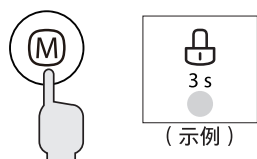

為防止兒童誤按按鍵，可鎖定主機上的按鍵。

- 在裝置運作期間，長按「**M**」按鈕超過 3 秒。「**3 s**」指示燈會亮起，而除了「**⏻**」按鈕外，所有按鈕都會被鎖定，無法操作。（仍然可以停止操作。）
- 要解除鎖定，請再次長按「**M**」按鈕超過 3 秒。「**3 s**」指示燈會關閉。

自動關機功能

若連續運轉 24 小時後無任何操作，風扇將自動關機。

設定擺放位置

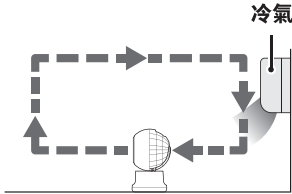

使用冷氣時

為了循環在地板積聚的冷空氣，將風扇背面朝向空調的出風口，並將氣流水平吹出。

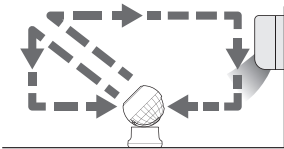

使用暖氣時

為了循環在天花板附近積聚的暖空氣，將風扇背面朝向空調的出風口，並將氣流向上吹向天花板。

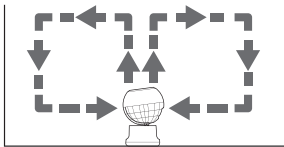

循環空氣時

透過將氣流導向容易積聚空氣的天花板，或使用擺動功能，可以減少室內溫度和濕度分佈不均的情況。

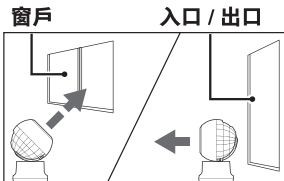

換氣時

將風扇放置在窗戶或房間門口附近，以促進空氣排出或吸入（換氣）。

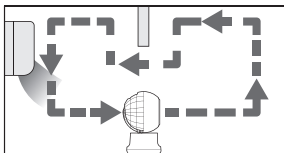

在兩個房間之間循環空氣時

將風扇放置在兩個房間的交界處，以促進它們之間的空氣流通。

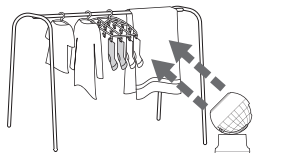

晾曬衣物時

將風扇放置在使氣流能夠直接吹到所有衣物的位置。

規格

型號	F-DCE70HK(W)
操作電壓	220-240V~
額定頻率	50/60Hz
功率	20W
噪音	≤64dB(A)
產品淨重	2.5kg
產品尺寸(WxDxH)	226x209x344mm

清潔與保養

注意事項

- 清潔本產品前，請務必關閉電源開關並拔下電源插頭。
- 清潔保養後，務必等待其完全乾燥後再接通電源使用或存放。
- 長時間不使用時，請拔下電源插頭。建議用原包裝包好，存放在乾燥的地方。
- 請勿直接用水沖洗機身。請使用沾有少許中性清潔劑的軟布輕輕擦拭機身表面，然後擦乾。請勿使用汽油等溶劑。
- 禁止自行拆卸改裝。建議定期檢查及清潔風扇，以延長使用壽命。

故障排除

風扇使用中出現異常時，請在送修前檢查以下幾點。

問題	檢查下列項目
風扇葉片不轉動。	<ul style="list-style-type: none">• 風扇葉片是否安裝正確？• 電源插頭是否正確插入插座？• 是否有風扇葉片接觸保護蓋？
風扇葉片轉動但發出怪聲。	<ul style="list-style-type: none">• 螺旋集線器蓋是否正確固定了風扇葉片？• 前後護網是否安裝正確？• 是否有風扇葉片接觸保護蓋？• 風扇葉片和保護蓋是否乾淨？
無法用遙控器操作	<ul style="list-style-type: none">• 電池是否已耗盡？<ul style="list-style-type: none">- 請重新裝入電池。• 發射部分是否朝向主機？或是否有任何障礙物？<ul style="list-style-type: none">- 操作範圍只可於約為 5 米，左右角度約 30°，且無障礙物情況下進行。• 電池的保護膜是否已移除？<ul style="list-style-type: none">- 產品出廠時，會放入保護膜以防止遙控器電池消耗。請在使用前將其移除。

#DetailsMatter



USER MANUAL

AIR CIRCULATION FAN
F-DCE70HK(W)



TOSHIBA

CONTENTS

IMPORTANT SAFETY INSTRUCTIONS 02

SAFE OPERATING RULES 04

PART NAME 05

LIST OF PARTS..... 05

PRODUCT INSTALLATION..... 06

DESCRIPTION OF CONTROL PANEL 08

DESCRIPTION OF REMOTE-CONTROL BUTTONS..... 08

HOW TO USE..... 09

AUTOMATIC SHUT DOWN FUNCTION 12

SETTING PLACE 12

SPECIFICATIONS..... 13

CLEANING AND MAINTENANCE..... 13

TROUBLESHOOTING 13

Thank you very much for purchasing Toshiba fan.

- In order to use this fan correctly and safely, please read this manual carefully and fully understand its contents before using it.
- After reading this manual, please keep it handy for easy reference.

IMPORTANT SAFETY INSTRUCTIONS

Safety precautions

Always follow these instructions!

This manual provides instructions that must be observed when using the fan in order to prevent danger to the user, other persons, and property.





NOTE









- This section describes the content and importance of safety matters to prevent personal injury or property damage to users or others. Please read the text with a full understanding of the following content, and be sure to abide by the safety precautions described.
- Do not operate with hand as it will cause the shutdown reset position to deviate if the fan is moved by hand during operation.



CAUTION

Read Rules for Safe Operation and Instructions Carefully.

WARNING





 Warning	If the supply cord is damaged, it must be replaced by manufacturer or its service agent or a similarly qualified person in order to avoid a hazard.
 Warning	Indoor use only.
 Warning	To protect against the risk of electrical shock, do not immerse the unit, cord or plug in water or other liquid.
 Warning	When the appliance is not in use and before cleaning, unplug the appliance from the outlet.

 Warning	<p>This appliance is not intended for use by persons (including children) with reduced physical, sensory or mental capabilities, or lack of experience and knowledge, unless they have been given supervision or instruction concerning use of the appliance by a person responsible for their safety. Children should be supervised to ensure that they do not play with the appliance.</p>
 Warning	<p>Keep electrical appliances out of reach from Children or infirm persons. Do not let them use the appliances without supervision.</p>
 Warning	<p>Do not connect the power supply until the product is installed.</p>
 Warning	<p>Make sure the product is disconnected from the power supply before removing the protective casing.</p>
 Warning	<p>Do not plug or unplug the power plug with wet hands to avoid the risk of electric shock.</p>
 Warning	<p>Avoid using it near acid-base oils, insecticides, curtains and other items.</p>
 Warning	<p>Only the matching adapter can be used. Do not use other adapters so as to avoid danger.</p>
 Prohibited	<p>When the product is running, do not put your fingers or sharp objects into the grille.</p>

 Prohibited	<p>It is prohibited to use it in places where there are hanging objects that are easy to fall, where it is susceptible to impacts, or where the placement is unstable. The product should be placed stably when using it, please do not tip over or tilt.</p>
 Prohibited	<p>Cut off the power supply before moving the product.</p>
 Prohibited	<p>Avoid use in direct sunlight or high humidity environments for long periods of time.</p>

SAFE OPERATING RULES

 Matters that may cause minor injury or property damage.

 Warning	<p>Before use, please check whether the voltage used is the same as the voltage marked on the product.</p>
 Warning	<p>When you leave the machine or when the machine is not in use, turn off the power and unplug the power plug to avoid circuit failure and accidents.</p>
 Warning	<p>Before use, check whether the power cord and plug are damaged. If the power cord is damaged, it must be replaced by the manufacturer, its maintenance department or a specialist from a similar department in order to avoid danger.</p>
 Warning	<p>Do not use the fan near a window, as rain may cause an electric shock.</p>

PART NAME

Note:

The pictures in the manual are for reference only. The actual product in the packaging box shall prevail.

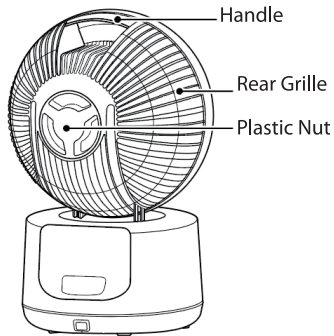
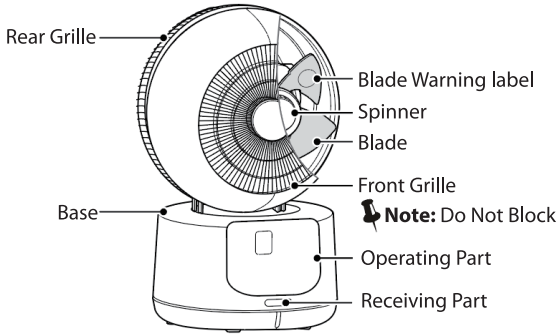

LIST OF PARTS



Remote control x1



Battery x2



User Manual x1

PRODUCT INSTALLATION

INSTALLATION METHOD

1. Place the back of the body facing the front. Open the rear grille to the state where the rear grille lock rod is open. Hold the rear grille with both hands, and be careful not to touch the main body. When inserting the main body, align the hole of the rear grille with the grille nut interface of the main body and install it. Turn the grille nut clockwise to the "Lock" position to ensure that the rear grille is firmly fixed.

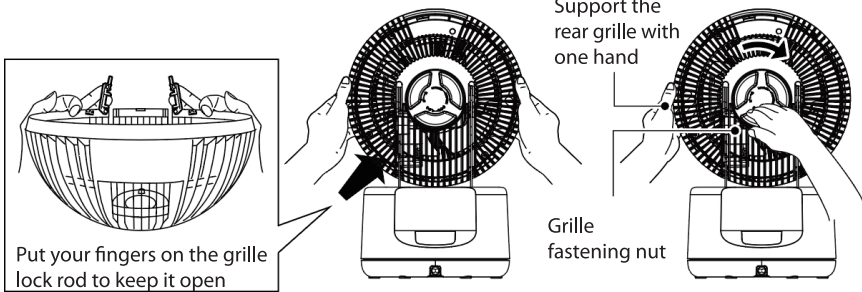

2. Place the front of the body facing up. Close the rear grille lock rod to ensure that the rear grille is locked.

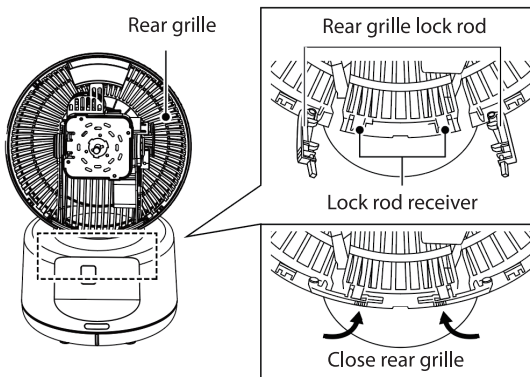

3. Align the recess on the back of the fan blade with the pin on the motor shaft, and ensure that the blade is securely inserted into place.

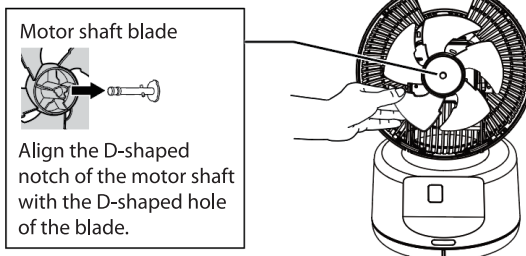

PRODUCT INSTALLATION

INSTALLATION METHOD

4. With the “●” mark on the front grille facing up, hold it with both hands, and align the “●” mark with the “⊕” mark of the rear grille. Turn the “●” mark on the front grille clockwise to align with the “⊕” mark of the rear grille.

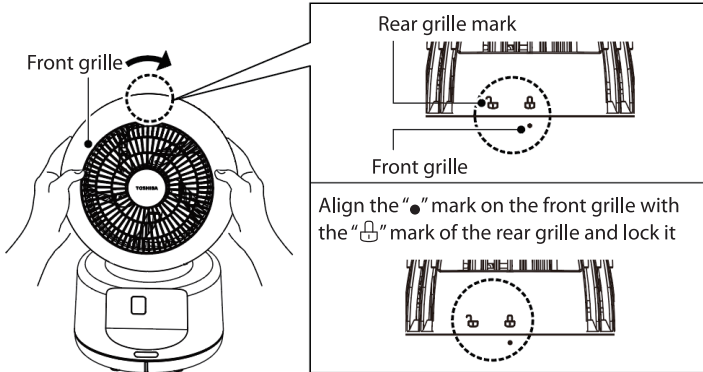

Note:

- Make sure that the “●” mark of the front grille and the “⊕” mark of the rear grille are correctly aligned.
- The grille may fall off during operation.
- After cleaning, wait for the body to dry before using it.

5. Finally, use screws to secure the front and rear mesh covers at the handle of the fuselage.

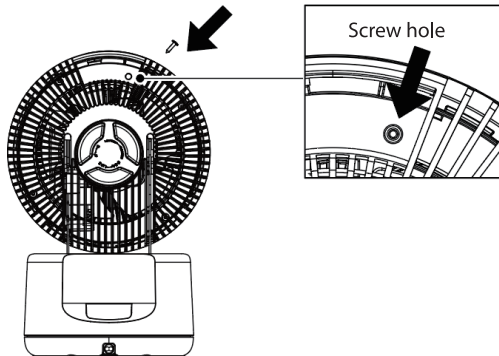

DESCRIPTION OF CONTROL PANEL

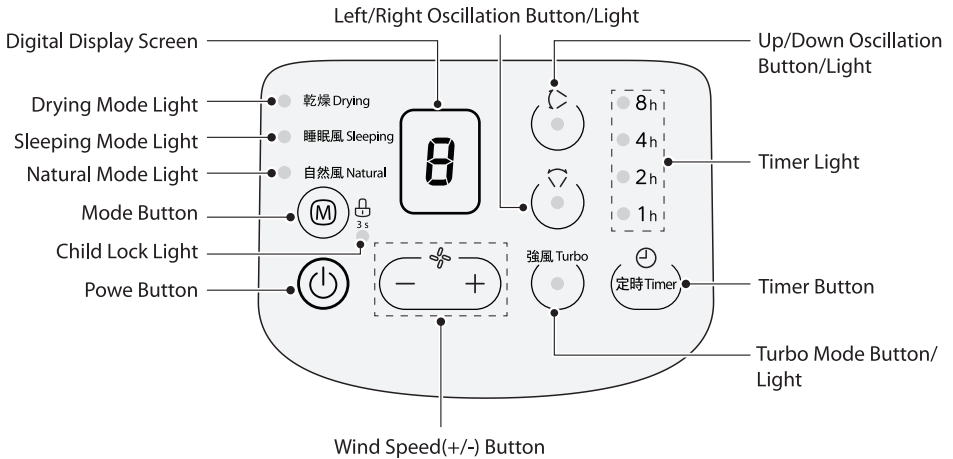

DESCRIPTION OF REMOTE-CONTROL BUTTONS

Note:

- The remote control can be used normally within 5m from the front of the product and the deviation angle is within 30°.
- Remote control batteries contain many heavy metals, acids and alkali and other substances, which threaten human health; used batteries should be classified and recycled.

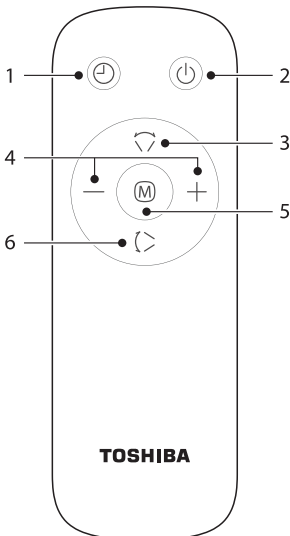

No	Button	Description	Function
1		Timer Button	• Set the timer for shutdown.
2		Power/Standby Button	• On/standby button.
3		Left/Right Oscillation Button	• Start or stop horizontal oscillator.
4		Increase/Decrease Button	• Adjust the wind speed level.
5		Mode Button	• When the fan is on, short press this button to switch modes (normal mode → drying mode → sleeping mode → natural model → turbo mode cycle.).
6		Up/Down Oscillation Button	• Start or stop vertical oscillator.

DESCRIPTION OF REMOTE-CONTROL BUTTONS

BATTERY INSTALLATION

- Remove the battery compartment cover by sliding with fingers.
- Insert Qty. 2 AAA batteries, and make sure the batteries are placed as shown (Figure 1).
- Install battery compartment cover by sliding the cover in the direction shown (Figure 1).

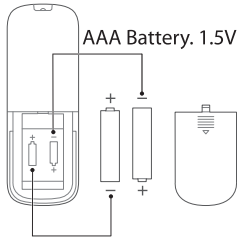
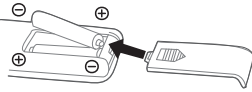

Figure 1



Note:

- The remote control uses AAA carbon-zinc batteries.
- Do not use rechargeable batteries.
- Non-rechargeable batteries are not to be recharged.
- Battery are to be inserted with the correct polarity. Exhausted batteries are to be removed from the appliance and safely disposed of.
- If the appliance is to be stored unused for a long period, the batteries are removed, the supply terminals are not to be short-circuited.
- Do not put the remote-control battery into re, or the battery may explode or leak.
- Do not mix old and new batteries. Do not mix alkaline, standard (carbon-zinc) or rechargeable (nickel-cadmium) batteries.

HOW TO USE

- **Operations on the main body operating part are explained. You can also perform the same operation with the remote control.**

1. Please insert it all the way in.

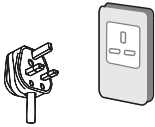

The buzzer sounds, and all the indicators light up for about 1 second.

2. Press the power button to start running



(Example)
Air volume 1

The air blows.
Press the power button again to stop.

3. Adjust the air volume

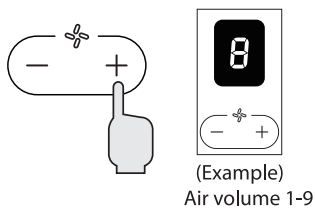

Each time you press the wind speed (+) button, you can switch the blowing intensity in 9 levels, and the air volume indicator light corresponding to the air volume will light up.

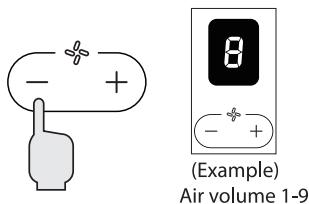

Each time you press the wind speed (-) button, the air volume will decrease by one level until it reaches the minimum level 1, and the corresponding air volume



4. Up/down left/right oscillator

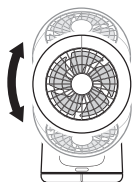
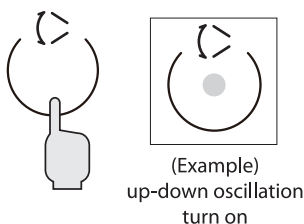

Press the “” button, and the product will emit a “beep” sound. The “” button light will turn on, and the up-down oscillation will start operating. To stop the oscillation, press the “” button again, and the button light will turn off.

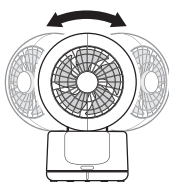
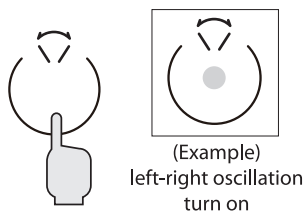

Press the “” button, and the product will emit a “beep” sound. The “” button light will turn on, and the left-right oscillation will start operating. To stop the oscillation, press the “” button again, and the button light will turn off.

5. Turbo mode

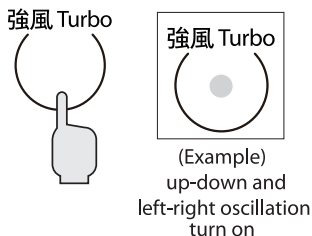

Press the “ 強風 Turbo” button, and the product will emit a “beep” sound. The “ 強風 Turbo” button light will turn on. Under this wind mode, the fan operates at maximum speed with both horizontal and vertical oscillation enabled. In this mode, the oscillation function cannot be turned off. To exit this mode, press “ 強風 Turbo” button again, and the button light will turn off. In this mode, the digital display screen displays like a running light.

6. Schedule off operation setting time: 1-15 hours

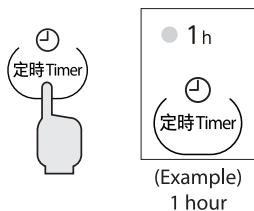

Press the schedule off button during operation to set the schedule off (the time can be set to 1-15h hours).

The indicator light corresponding to the set time lights up.



The duration of the timer corresponds to the cumulative digital display on the timer light.

- If you want to cancel the schedule off setting, please press the schedule off button to turn off the schedule off indicator. Or press the power button to stop, turn on and restart.
- When schedule off isn't turned on, functions cannot be set in power-off state.

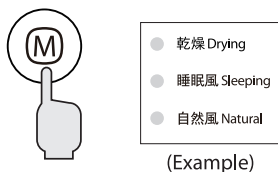
7. Select wind mode

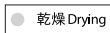

Press “**M**” button to select normal mode, drying mode, sleeping mode, natural model, turbo model circulating among the five wind modes.

<p>Drying mode</p> 	<ul style="list-style-type: none"> • “乾燥 Drying” Light on, activating the drying mode, while both vertical and horizontal swing functions are enabled. • In this mode, the indicator lights for the vertical and horizontal swing buttons will also turn on, and the swing functions can be turned off if needed.
<p>Sleeping mode</p> 	<ul style="list-style-type: none"> • “睡眠風 Sleeping” Light on, start the sleeping mode. There are three levels of sleep wind to choose; while both vertical and horizontal swing functions are enabled. • In this mode, the buttons are on mute.
<p>Natural mode</p> 	<ul style="list-style-type: none"> • “自然風 Natural” Light on, activating the Natural mode, while both vertical and horizontal swing functions are enabled. And there are three levels of natural wind to choose. • In this mode, the indicator lights for the vertical and horizontal swing buttons will also turn on, and the swing functions can be turned off if needed.

8. Set Child Lock

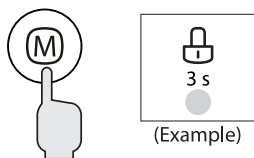

To prevent children from accidentally pressing keys, the buttons on the main unit can be locked.

- While the device is running, press and hold the “**M**” button for more than 3 seconds. The “ $\frac{\text{M}}{3\text{s}}$ ” indicator light will turn on, and all buttons except the “**⏻**” button will be locked and cannot be operated. (Stopping operation is still possible.)
- To unlock, press and hold the “**M**” button again for more than 3 seconds. The “ $\frac{\text{M}}{3\text{s}}$ ” indicator light will turn off.

AUTOMATIC SHUT DOWN FUNCTION

The fan will automatically shut down if there is no operation after 24 hours of continuous operation.

SETTING PLACE

Air conditioner

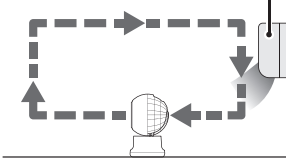

When using cooling

To circulate the cold air that accumulates on the floor, position the fan with its back to the air conditioner's vent and direct the airflow horizontally.

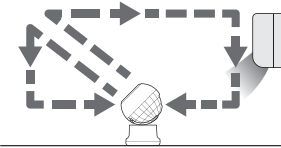

When using heating

To circulate the warm air that accumulates near the ceiling, position the fan with its back to the air conditioner's vent and direct the airflow upward toward the ceiling.

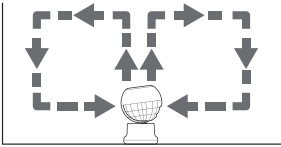

When circulating air

By directing airflow toward the ceiling where air tends to stagnate or using the oscillation function, you can reduce uneven temperature and humidity distribution in the room.

Window Entrance/Exit

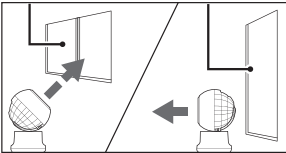

When ventilating

Place the fan near windows or room entrances to facilitate air exhaust or intake (ventilation).

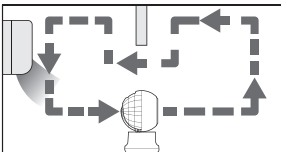

When circulating air between two rooms

Position the fan near the boundary between two rooms to promote air circulation between them.

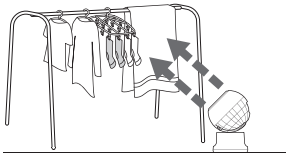

When drying laundry

Place the fan so that the airflow directly reaches the entire laundry load.

SPECIFICATIONS

Model	F-DCE70HK(W)
Operating voltage	220-240V~
Rated Frequency	50/60Hz
Power	20W
Noise	≤64dB(A)
Product Weight	2.5kg
Product Size (WxDxH)	226x209x344mm

CLEANING AND MAINTENANCE

Precautions

- Before cleaning this product, be sure to turn off the power switch and unplug it.
- After cleaning and maintenance, be sure to wait until it is fully dry before powering on for use or storage.
- Please unplug the power cord when not in use for a long time. It is recommended to wrap it in the original packaging and store it in a dry place.
- Do not rinse the machine body directly with water. Use a soft cloth containing a little neutral detergent to gently wipe the surface of the machine, and then wipe it dry. Do not use solvents such as gasoline.
- It is prohibited to disassemble the machine for modification. It is recommended to check and clean the machine regularly to extend its service life.

TROUBLESHOOTING

If the fan appears abnormal during use, please check the following points before repair.

Problem	Check the following
The fan blades do not rotate.	<ul style="list-style-type: none"> • Are the fan blades installed correctly? • Is the power plug inserted into the socket correctly? • Is there a fan blade contact protective cover?
The fan blades rotate but make a strange sound.	<ul style="list-style-type: none"> • Does the spiral hub cap secure the fan blades in place correctly? • Are the front and rear guards installed correctly? • Is there a fan blade contact protective cover?
Cannot operate with the remote control	<ul style="list-style-type: none"> • Are the batteries exhausted? <ul style="list-style-type: none"> - Reload the battery. • Is the transmitting part facing the main unit? Or are there any obstacles? <ul style="list-style-type: none"> - The operation can only be carried out within the angle range of about 30° left and right at a distance of about 5m without obstacles. • Has the protective film on the battery been removed? <ul style="list-style-type: none"> - When the product leaves the factory, a protective film is inserted to prevent the battery of the remote control from being consumed. Please remove it before use.

#DetailsMatter