

使用說明書

微波爐

MM-2MM20PC(WH)

操作前請先閱讀本說明書。

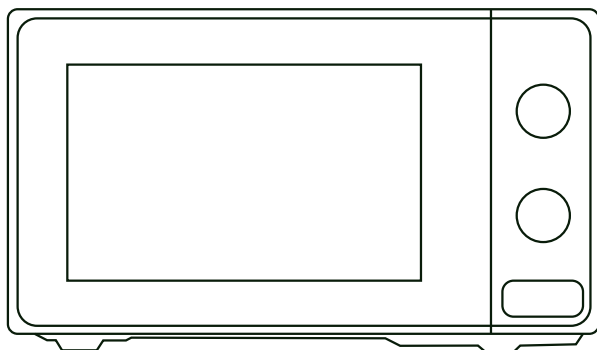

TOSHIBA

目錄

產品安全

避免接觸過量微波能量的預防措施	ZH-01
重要安全說明	ZH-03
減少接地安裝人士受傷的風險	ZH-07
清潔	ZH-09
器皿	ZH-10
可在微波爐中使用的物料.....	ZH-11
不可用於微波爐的材料	ZH-13

產品設置

設定爐具	ZH-14
------------	-------

使用說明

第一次使用前	ZH-17
操作	ZH-18

清潔及保養

清潔	ZH-19
故障排除	ZH-21



注意

操作本產品前，請閱讀、理解及遵循本說明書。
請確保妥善保管本小冊子，以供日後參考。

避免接觸過量微波能量的預防措施

- (a). 爐門開啟時請勿操作微波爐，因為這可能會接觸到微波能量而造成傷害。請勿破壞或更改安全連鎖。
- (b). 請勿在爐具正面及爐門之間放置任何物品，或讓泥土或清潔劑殘留物在密封表面積聚。
- (c). **警告：** 爐門或爐門密封條如有損壞，必須由合資格人士修理，然後才操作微波爐。

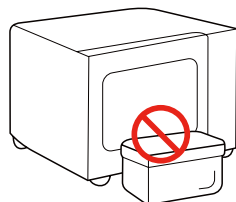

附錄

如果設備沒有保持清潔，其表面可能會變質，從而影響設備的使用壽命並導致危險。

規格

型號	MM-2MM20PC(WH)
額定電壓	220V~50Hz
額定輸入功率（微波）	1270W
額定輸出功率（微波）	800W

重要安全說明



警告

為減少使用產品時發生火災、觸電、人身傷害或接觸過量微波爐能量的風險，請遵循以下基本預防措施：



請閱讀並遵循：「《避免接觸過量微波能量的預防措施》」。



在缺乏負責其安全的人士監督或指導之下，身體感到不適、精神狀態不佳或缺乏相關經驗與知識的人士（包括兒童），均不適宜使用本產品。



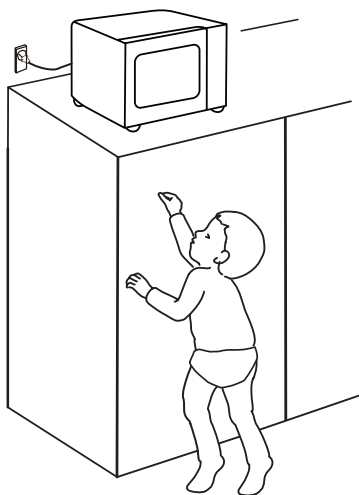

應看管兒童，確保他們不會把玩產品。





電線如有損壞，請由製造商、代理商或具類似資格的專業人士更換，以免發生危險。

重要安全說明

 **警告：** 更換燈泡之前，請確保已關閉產品電源，以免觸電。

 **警告：** 除合資格人士外，任何涉及拆除防微波外罩的保養或維修操作均十分危險。

 **警告：** 切勿在密封容器中加熱液體及其他食物，否則可能會爆炸。

 使用塑膠或紙製容器加熱食物時，請注意微波爐，因為可能會著火。



 僅使用適合在微波爐使用的器皿。

 如果冒煙，請關閉產品或拔下電源插頭，並保持爐門關閉，以消滅火種。

 微波加熱飲品可導致延遲沸騰，因此在處理容器時必須小心。

 奶瓶及嬰兒食品瓶中的內容物，應在食用前攪拌或搖動，並檢查溫度，以免燙傷。

 微波爐應定期清潔，並清除所有食物沉積物。

重要安全說明

請保持微波引導區清潔。當微波引導區或腔體上有食物飛濺的殘留物時，請使用柔軟的濕布進行清理。如果不清理食物殘渣，可能會導致微波爐腔內出現無害的火花或一些煙霧，爐腔內也可能出現變色。

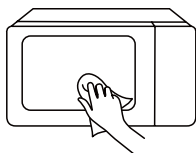

 沒有保持微波爐清潔，可能會導致表面變質，從而對產品的使用壽命產生不良影響，並導致危險。

 請僅使用推薦用於此爐具的溫度探針。（如微波爐配備使用溫度感應探針設備。）

 微波爐在操作時必須開啟飾門。（適用於帶有裝飾門的爐具。）

 本產品供家居及類似環境使用，如：

1. 店舖內的員工廚房區域、辦公室及其他工作環境；
2. 供客戶於酒店、汽車旅館及其他住宅類型環境；
3. 農舍；
4. 民宿類型環境。

 微波爐用於加熱食物及飲品。用於乾燥食物或衣物，以及加熱保溫墊、拖鞋、海綿、濕布等可能會導致受傷、著火或火災的危險。

重要安全說明

 本產品僅供獨立使用。

 產品背面應靠牆擺放。

 切勿在微波爐加熱連殼雞蛋或整隻焗蛋，否則可能會在微波加熱後爆炸。

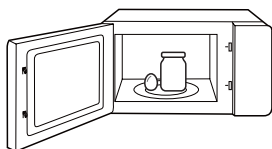

 切勿將本產品安裝在裝飾門後面，以免過熱。
(不適用於帶裝飾門的電器。)

 除非已在櫥櫃對微波爐進行測試，否則請勿將微波爐放入櫥櫃。

 微波烹調期間不得使用金屬容器盛載食物及飲品。

 不得使用蒸汽清潔器清潔產品。

請仔細閱讀並保存以備日後參考

減少接地安裝人士受傷的風險

本產品必須接地。如發生電氣短路，接地可通過為電流提供逃逸通路來降低觸電危險。

本產品配備帶有接地線及接地插頭的電源線。插頭必須插入正確安裝並接地的插座。

警告 - 接地使用不當可導致觸電。如未充分理解接地說明，或對產品是否正確接地存有疑問，請諮詢合資格電工或維修人員。如需要使用延長線，請僅使用 3 線延長線。



危險

觸電危險：

觸摸部分內部組件，可導致嚴重的人身傷害或死亡。請勿拆解本產品。

減少接地安裝人士受傷的風險



觸電危險：

接地使用不當可導致觸電。在正確安裝產品並將其接地之前，請勿插入電源插座。

1. 產品隨附短電源線，以減低長電源線纏繞及絆到造成的危險。
2. 如使用長電源線或延長線：
 - (1). 電源線組或延長線標記的電氣額定值應至少與產品的電氣額定值一樣大。
 - (2). 延長線必須為接地型 3 線電源線。
 - (3). 應妥善擺放長電源線，使其不會掛在檯面或桌面，以免被兒童拉扯或意外絆倒。

清潔

確保從電源插座拔下產品插頭。

1. 使用後，用濕布清潔微波爐腔。
2. 用一般的方法在肥皂水中清潔配件。
3. 爐門框、密封條及附近零件骯髒時，必須小心用濕布清潔。
4. 請勿使用粗糙的研磨劑或鋒利的金屬刮刀來清潔微波爐爐門玻璃，否則會劃傷表面，導致玻璃破碎。
5. 清潔提示——為了能更輕鬆清潔烹調食物會接觸到的腔壁：將半個檸檬放入碗中，加入 300 毫升（1/2 品脫）水，並用 100% 微波火力加熱 10 分鐘。用柔軟的乾布擦拭微波爐。

器皿



人身傷害危險：

除合資格人士外，任何涉及拆除防微波外罩的保養或維修操作均十分危險。

請參閱「可用於微波爐的材料」或「不可用於微波爐的材料」的說明」

部分非金屬器皿可能不適用於微波。如有疑問，可以按照以下步驟測試相關器皿。

器皿測試：

1. 在適用於微波爐的容器加入 1 杯冷水（250毫升），並與相關器皿一同放入微波爐。
2. 以最大火力煮一分鐘。
3. 小心觸摸器皿。如果空的器皿很熱，請勿將其用於微波爐烹調。
4. 烹調時間切勿超過1分鐘。

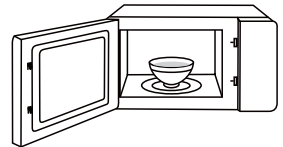



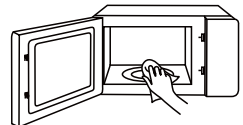





保持爐腔和波導蓋區域清潔

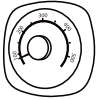

可在微波爐中使用的物料

器皿	備註
 烤盤	請遵循製造商說明。 燒烤盤底部必須在轉盤上方至少 3/16 英寸（5 毫米）。 不正確使用可能會導致轉盤破裂。
 餐具	僅限可用於微波的餐具。請遵循製造商說明。請勿使用破裂或有缺口的盤子。
 玻璃瓶	務必取下蓋子。僅用於加熱食物至溫熱。大部分玻璃瓶均不耐熱，且可能會破裂。
 玻璃器皿	僅限耐熱微波爐玻璃器皿。確保沒有金屬裝飾。 請勿使用破裂或有缺口的盤子。
 微波爐烹調袋	請遵循製造商說明。請勿用金屬帶索緊。 預留縫隙以便蒸汽逸出。
 紙碟及紙杯	僅用於短時間烹飪/加熱。烹調時請勿離開。
 廚房紙	用於覆蓋食物進行加熱和吸收油脂。僅用於短時間烹調，烹調時請勿離開。
 烘焙紙	用於覆蓋食物以防止飛濺或包裹蒸煮的食物。

可在微波爐中使用的物料

器皿	備註	
 塑膠	僅限可用於微波的餐具。請遵循製造商說明。應標有「可用於微波」標籤。部分塑膠容器會因內裏的食物變熱而變軟。「蒸煮袋」和密封塑膠袋應按照包裝說明切開、穿洞或開孔。	
 保鮮膜	僅限可用於微波的餐具。用於在烹調期間覆蓋食物以保留水分。請勿讓保鮮膜接觸食物。	
 溫度計	僅使用適用於微波爐者（肉類及糖類溫度計）。	
 食品蠟紙	用於覆蓋食物，以防止飛濺並保留水分。	

不可用於微波爐的材料

器皿	備註	
 鋁盤	可能引起擊穿。將食物轉移到適用於微波的盤子。	⊗
 帶金屬手柄的食品紙箱	可能引起擊穿。將食物轉移到適用於微波的盤子。	⊗
 金屬或金屬飾面的器皿	金屬會隔離食物吸收微波能量。 金屬裝飾可能會引起擊穿。	⊗
 金屬紮帶	可能引起擊穿並導致微波爐著火。	⊗
 紙袋	可能導致微波爐著火。	⊗
 塑膠泡沫	塑膠泡沫處於高溫時，可能會熔化或污染內裏的液體。	⊗
 木材	在微波爐使用時，木材會變乾，並可能裂開或破裂。	⊗

產品設置

設定爐具

(如果設備與本說明書中的圖片有任何差異，則概以實際產品為準)。

微波爐零件和附件名稱

從紙箱及微波爐腔取出微波爐及所有材料。



轉盤環組件



使用說明書

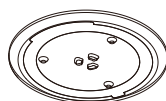

玻璃轉盤



轉盤軸

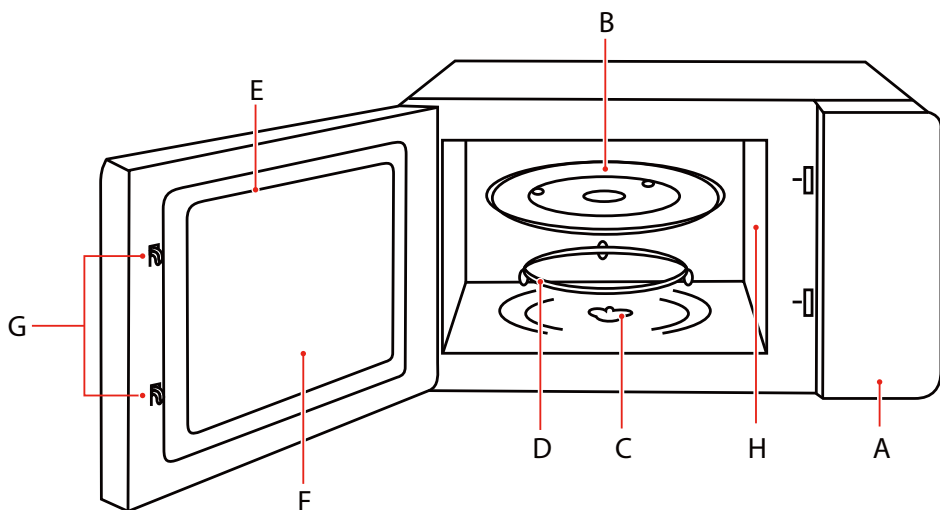

- A. 控制面板
- B. 玻璃托盤
- C. 轉盤軸
- D. 轉盤環組件

- E. 爐門組件
- F. 觀察窗
- G. 安全連鎖系統
- H. 波導蓋

設定爐具

轉盤安裝

清潔烹飪艙並放置轉盤。

新安裝時，請確保所有包裝和運送膠帶都已從轉盤軸移除。

在第一次使用設備準備食物之前，你需要將轉盤正確放置。你必須清潔烹飪艙和附件。

你也可以就其參閱清潔部分。

如何把轉盤放好：

1. 將轉盤環組件③，放入烹飪室的凹槽中。
2. 將玻璃托盤①，放在轉盤環組件③上。將凸起的弧形線裝入玻璃托盤底部的中心，位於軸的三個輻條之間。確保玻璃托盤①妥為接觸烹飪艙下方中央的轉盤軸②。軸上的滾輪應貼合轉盤底脊內。

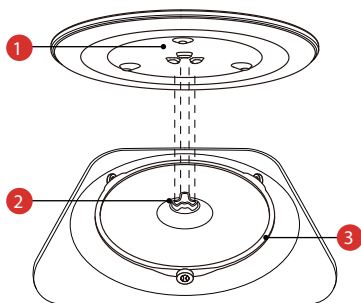

- 1) 玻璃托盤
- 2) 轉盤軸
- 3) 轉盤環組件

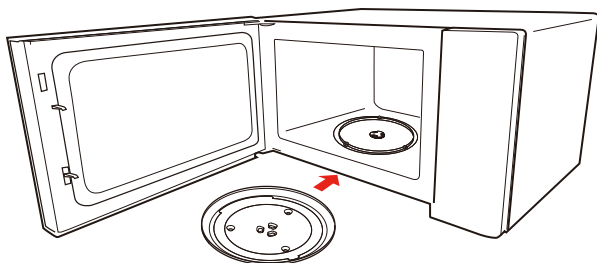

注意

- 永遠不要在沒有轉盤的情況下使用此電器。確保正確貼合。轉盤可以順時針或逆時針轉動。
- 切勿將玻璃托盤倒置。玻璃托盤永遠不應受限制。
- 烹調期間必須使用玻璃托盤及轉盤環組件。
- 烹調期間所有食物及食物容器均須放上玻璃托盤。
- 千萬不要限制轉盤移動。
- 玻璃托盤或轉盤環組件如有損壞或破裂，請聯絡就近的授權服務中心。

工作台安裝

拆除所有包裝材料及配件。檢查微波爐是否有任何損壞，如凹痕或爐門破損。微波爐如有損壞，請勿安裝。

微波爐：取下微波爐表面的所有保護膜。請勿取下附在微波爐腔上用於保護磁電管的波導蓋。

安裝

1. 選擇一個進氣口及/或出氣口均有足夠空間的水平表面。
 - a. 安裝高度應不少於 85 厘米。
 - b. 產品背面應靠牆擺放。在烤箱上方至少留出 30 厘米的間隙。爐具與任何相鄰的牆壁之間，需要有至少 20 厘米的間隙。
 - c. 請勿拆除微波爐底部的支架。
 - d. 阻塞進氣口及/或出氣口會損壞微波爐。
 - e. 將微波爐置於遠離收音機及電視的地方。操作微波爐可能會干擾收音機或電視接收信號。

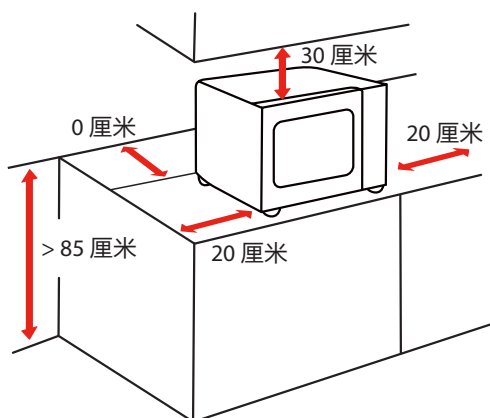

側面	距離 厘米
頂部	30 厘米
左側	20 厘米
右側	20 厘米
背面	0 厘米
正面	開放

2. 將微波爐插入標準家用插座。確保電壓及頻率與額定標籤上標示的相同。



注意

- 請勿將微波爐安裝在爐灶或其他發熱電器之上。如果安裝在熱源附近或上方，微波爐可能會損壞，保證將會無效。

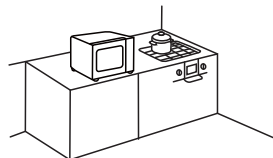

操作期間，可接觸表面可能會變熱

第一次使用前

第一次使用爐具時，可能會產生難聞的氣味，這是正常現象。

本節告訴你在第一次使用微波爐準備食物之前需要如何處理。事先閱讀標題為「**產品安全**」的章節。

在你可以使用你的新電器之前，你需要把轉盤正確放好。你亦必須清潔烹飪艙和附件。



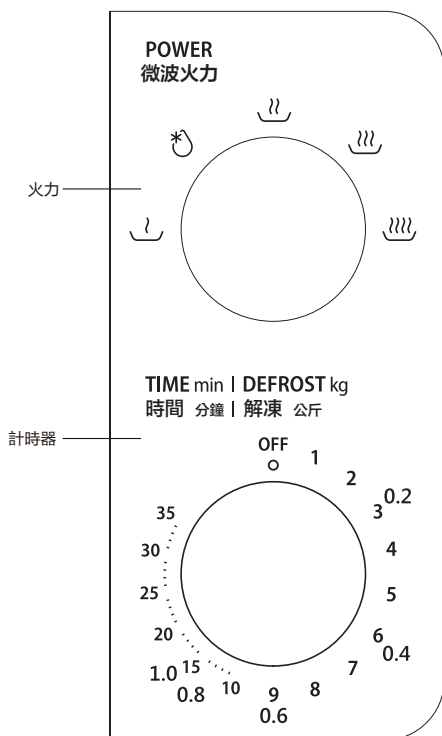

- 永遠不要在沒有轉盤的情況下使用此電器。
- 確保其正確貼合。轉盤可以順時針或逆時針轉動。

操作



1. 通過將功率旋鈕旋轉到所需的水平，以設定烹飪功率。
2. 根據你的食物烹飪指南，通過旋轉計時器旋鈕到所需時間，以設置烹飪時間。
3. 在完成設定好功率等級及時間後，微波爐會自動開始烹飪。
4. 烹飪時間結束時，裝置將發出「咚」一聲以表示停止。
5. 不使用本設備時，請確保將時間設定為「0」。

功能 / 功率	輸出	應用
低 	17% 微波	軟化雪糕
中低(解凍) 	33% 微波	燉湯、軟化牛油或解凍
中 	55% 微波	燉湯、魚
中高 	77% 微波	飯、魚、雞肉、肉碎
高 	100% 微波	翻熱、牛奶、煲水、蔬菜、飲品



從爐具中取出食物時，請確保將定時器開關調至 0 (零)，以關閉爐具電源。
如果不這樣做，並在沒有食物在內的情況操作微波爐，則可能導致過熱和損壞磁控管。

清潔

透過妥善保養及清潔，您的產品將保持外觀，並在一段長時間維持正常運作。這裡將說明應如何正確保養及清潔產品。



- 爐門上的玻璃刮痕可能發展成裂縫。切勿使用玻璃刮刀、鋒利或具研磨性的清潔用品或清潔劑。
- 如果清潔不當，設備的表面可能會受損。微波能量可能會逸出。定期清潔電器，並立即清除任何食物殘渣。
- 請勿將電器浸泡在水中或者在水柱下清洗。

清潔劑

為確保使用正確的清潔劑，以免損壞各個表面，請遵循表內說明。使用前請徹底清洗新的海綿布。

切勿使用：



粗糙或研磨性清潔劑



金屬或玻璃刮刀清潔門板



金屬或玻璃刮刀清潔門封條



堅硬的百潔布或海綿



酒精含量高的清潔劑

電器正面

熱肥皂水：

用抹布清潔，然後用軟布擦乾。
切勿使用金屬或玻璃刮刀進行清潔。

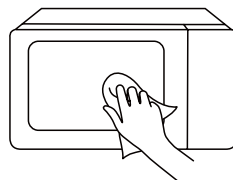

不銹鋼器具的正面

熱肥皂水：

用抹布清潔，然後用軟布擦乾。

立即清除水垢、油脂、澱粉和白蛋白的飛濺和斑塊。這些斑塊或飛濺物下，可形成腐蝕。切勿使用玻璃清洗劑或金屬或玻璃刮刀清潔。

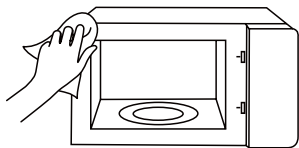

以不銹鋼製成的烹飪間隔

熱肥皂水或醋溶液：

用抹布清潔，然後用軟布擦乾。切勿使用爐具噴劑或任何其他腐蝕性的爐具清潔劑或研磨材料。洗滌墊、粗糙的海綿和鍋具清潔劑亦不合適使用。這些物品會擦花表面。待內裡表面完全變乾。

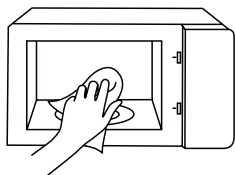

烹飪艙中的凹槽

濕布：

不得讓水通過轉盤驅動裝置流入電器。用布擦乾轉盤驅動器。

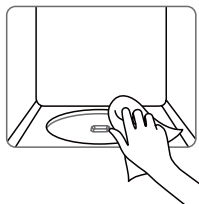

轉盤和滾環

熱肥皂水：

當把轉盤放回其凹槽時，必須正確接合。



門板

玻璃清潔劑：

用抹布清潔。切勿使用玻璃刮刀。

故障排除

正常

微波爐干擾電視接收信號

微波爐運行時可能會干擾收音機及電視接收信號。這與攪拌機、吸塵器及電風扇等小型電器的干擾相似。此屬正常現象。

微波爐燈變暗

低火力微波烹調期間，微波爐的燈光可能會變暗。此屬正常現象。

蒸汽積聚在爐門，熱空氣從通風孔流出

烹調期間，食物可能會冒出蒸汽。大部分蒸汽會從通風口逸出。但是部分蒸汽可能會積聚在微波爐門等陰涼的地方。此屬正常現象。

微波爐在沒有放入食物時意外地開始烹調。

嚴禁在沒有任何食物的情況下運作本設備。這會非常危險。

問題	可能的原因	解決方法
	(1) 電源線並未插實。	拔出電源線。然後 10 秒後再次插入。
微波爐無法啟動。	(2) 保險絲熔斷或斷路器運作。	更換保險絲或重設斷路器 (由本公司的專業人士進行維修)。
	(3) 插座出現問題。	使用其他電器測試插座。
微波爐沒有加熱。	(4) 爐門尚未關好。	關好爐門。



根據廢棄電子及電力裝置 (WEEE) 指令, WEEE 須單獨收集及處理。如果將來你需要處理本產品, 請勿將本產品與家庭垃圾一起處理。請將此產品傳送至適用 WEEE 收集點。

#DetailsMatter

INSTRUCTION MANUAL

MICROWAVE OVEN

MM-2MM20PC(WH)

Please review this instruction manual before operating.

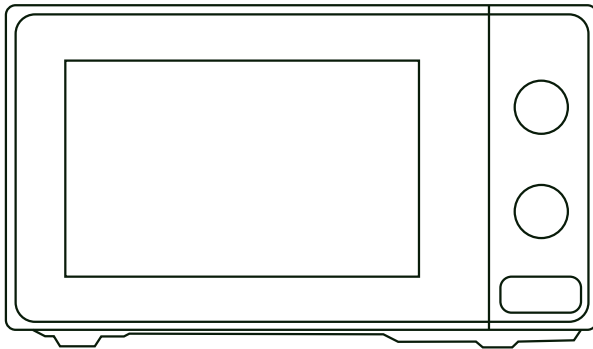

TOSHIBA

CONTENTS

PRODUCT SAFETY

Precautions to avoid possible exposure to excessive microwave energy	EN-01
Important safety instructions	EN-03
To reduce the risk of injury to persons grounding installation.....	EN-07
Cleaning.....	EN-09
Utensils.....	EN-10
Materials you can use in microwave oven	EN-11
Materials can not be used in microwave oven	EN-13

PRODUCT SETTING

Setting up your oven	EN-14
----------------------------	-------

INSTRUCTION FOR USE

Before using for the first time	EN-17
Operation.....	EN-18

CLEANING AND MAINTENANCE

Cleaning.....	EN-19
Trouble shooting.....	EN-21



NOTE

BEFORE OPERATING THIS PRODUCT, READ, UNDERSTAND, AND FOLLOW THESE INSTRUCTIONS. BE SURE TO SAVE THIS BOOKLIST FOR FUTURE REFERENCE.

PRECAUTIONS TO AVOID POSSIBLE EXPOSURE TO EXCESSIVE MICROWAVE ENERGY

- (a). Do not attempt to operate this oven with the door open since this can result in harmful exposure to microwave energy. It is important not to break or tamper with the safety interlocks.
- (b). Do not place any object between the oven front face and the door or allow soil or cleaner residue to accumulate on sealing surfaces.
- (c). **WARNING:** If the door or door seals are damaged, the oven must not be operated until it has been repaired by a competent person.

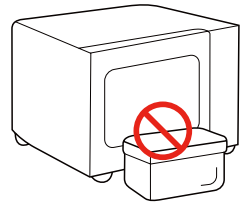

ADDENDUM

If the apparatus is not maintained in a good state of cleanliness, its surface could be degraded and affect the lifespan of the apparatus and lead to a dangerous situation.

SPECIFICATIONS

MODEL	MM-2MM20PC(WH)
RATED VOLTAGE	220V~ 50Hz
RATED INPUT POWER(MICROWAVE)	1270 W
RATED OUTPUT POWER(MICROWAVE)	800 W

IMPORTANT SAFETY INSTRUCTIONS



WARNING

To reduce the risk of fire, electric shock, injury to persons or exposure to excessive microwave oven energy when using your appliance, follow basic precautions, including the following:



Read and follow the specific: "**PRECAUTIONS TO AVOID POSSIBLE EXPOSURE TO EXCESSIVE MICROWAVE ENERGY**".



This appliance is not intended for use by persons (including children) with reduced physical, sensory or mental capabilities, or lack of experience and knowledge, unless they have been given supervision or instruction concerning use of the appliance by a person responsible for their safety.



Children should be supervised to ensure that

they do not play with the appliance.

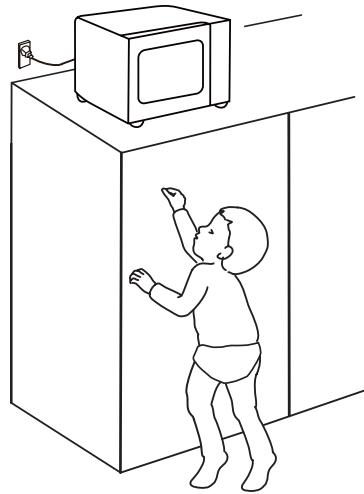



If the supply cord is damaged, it must be replaced by the manufacturer, its service agent or similarly qualified persons in order to avoid a hazard.

IMPORTANT SAFETY INSTRUCTIONS

 **WARNING:** Ensure that the appliance is switched off before replacing the lamp to avoid the possibility of electric shock.

 **WARNING:** It is hazardous for anyone other than a competent person to carry out any service or repair operation that involves the removal of a cover which gives protection against exposure to microwave energy.

 **WARNING:** Liquids and other foods must not be heated in sealed containers since they are liable to explode.

 When heating food in plastic or paper containers, keep an eye on the oven due to the possibility of ignition.



 Only use utensils that are suitable for use in microwave ovens.

 If smoke is emitted, switch off or unplug the appliance and keep the door closed in order to stifle any flames.

 Microwave heating of beverages can result in delayed eruptive boiling, therefore care must be taken when handling the container.

 The contents of feeding bottles and baby food jars shall be stirred or shaken and the temperature checked before consumption, in order to avoid burns.

 The oven should be cleaned regularly and any

IMPORTANT SAFETY INSTRUCTIONS

food deposits removed. Please keep the waveguide area clean. Use soft damp cloth to clean it up when there is food splash residue on the waveguide area or the cavity. Failure to clean food residue may cause innocuous sparking or some smoke in the microwave cavity, discoloration of the cavity may also occur.

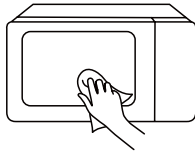

 Failure to maintain the oven in a clean condition could lead to deterioration of the surface that could adversely affect the life of the appliance and possibly result in a hazardous situation.

 Only use the temperature probe recommended for this oven. (for ovens provided with a facility to use a temperature-sensing probe.)

 The microwave oven must be operated with the decorative door open. (for ovens with a decorative door.)

 This appliance is intended to be used in household and similar applications such as:

1. staff kitchen areas in shops, offices and other working environments;
2. by clients in hotels, motels and other residential type environments;
3. farm houses;
4. bed and breakfast type environments.

 The microwave oven is intended for heating food and beverages. Drying of food or clothing and heating of warming pads, slippers, sponges, damp cloth and similar may lead to risk of injury, ignition or fire.

IMPORTANT SAFETY INSTRUCTIONS

 The appliance is intended to be used freestanding.

 The rear surface of appliances shall be placed against a wall.

 Eggs in their shell and whole hard-boiled eggs should not be heated in microwave ovens since they may explode, even after microwave heating has ended.

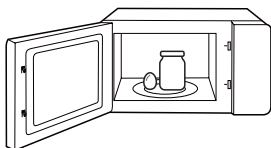

 The appliance must not be installed behind a

decorative door in order to avoid overheating. (This is not applicable for appliances with decorative door.)

 The microwave oven shall not be placed in a cabinet unless it has been tested in a cabinet.

 Metallic containers for food and beverages are not allowed during microwave cooking.

 The appliance shall not be cleaned with a steam cleaner.

READ CAREFULLY AND KEEP FOR
FUTURE REFERENCE

TO REDUCE THE RISK OF INJURY TO PERSONS GROUNDING INSTALLATION

This appliance must be grounded. In the event of an electrical short circuit, grounding reduces the risk of electric shock by providing an escape wire for the electric current.

This appliance is equipped with a cord having a grounding wire with a grounding plug. The plug must be plugged into an outlet that is properly installed and grounded.

WARNING - Improper use of the grounding can result in a risk of electric shock. Consult a qualified electrician or serviceman if the grounding instructions are not completely understood or if doubt exists as to whether the appliance is properly grounded.

If it is necessary to use an extension cord, use only a 3-wire extension cord.



DANGER

Electric Shock Hazard:

Touching some of the internal components can cause serious personal injury or death. Do not disassemble this appliance.

TO REDUCE THE RISK OF INJURY TO PERSONS GROUNDING INSTALLATION



WARNING

Electric Shock Hazard:

Improper use of the grounding can result in electric shock. Do not plug into an outlet until appliance is properly installed and grounded.

1. A short power-supply cord is provided to reduce the risks resulting from becoming entangled in or tripping over a longer cord.
2. If a long cord or extension cord is used:
 - (1). The marked electrical rating of the cord set or extension cord should be at least as great as the electrical rating of the appliance.
 - (2). The extension cord must be a grounding-type 3-wire cord.
 - (3). The longer cord should be arranged so that it will not drape over the counter top or tabletop where it can be pulled on by children or tripped over unintentionally.

CLEANING

Be sure to unplug the appliance from the power supply.

1. Clean the cavity of the oven after using with a slightly damp cloth.
2. Clean the accessories in the usual way in soapy water.
3. The door frame and seal and neighbouring parts must be cleaned carefully with a damp cloth when they are dirty.
4. Do not use harsh abrasive cleaners or sharp metal scrapers to clean the oven door glass since they can scratch the surface, which may result in shattering of the glass.
5. **Cleaning Tip**---For easier cleaning of the cavity walls that the food cooked can touch: Place half a lemon in a bowl, add 300ml (1/2 pint) water and heat on 100% microwave power for 10 minutes. Wipe the oven clean using a soft, dry cloth.

UTENSILS



CAUTION

Personal Injury Hazard:

It is hazardous for anyone other than a competent person to carry out any service or repair operation that involves the removal of a cover which gives protection against exposure to microwave energy.

See the instructions on "**Materials you can use in microwave oven**" or "**Materials can not be used in microwave oven**"

There may be certain non-metallic utensils that are not safe to use for microwaving. If in doubt, you can test the utensil in question following the procedure below.

Utensil Test:

1. Fill a microwave-safe container with 1 cup of cold water (250ml) along with the utensil in question.
2. Cook on maximum power for 1 min.
3. Carefully feel the utensil. If the empty utensil is warm, do not use it for microwave cooking.
4. Do not exceed 1 min cooking time.

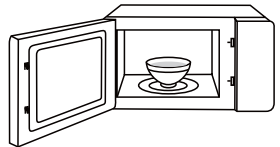





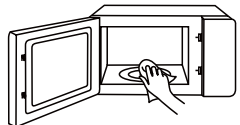











NOTE









KEEP THE CAVITY AND
WAVEGUIDE AREA CLEAN





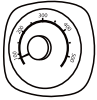



MATERIALS YOU CAN USE IN MICROWAVE OVEN

UTENSILS	REMARKS
 Browning dish	Follow manufacturer's instructions. The bottom of browning dish must be at least 3/16 inch (5mm) above the turntable. Incorrect usage may cause the turntable to break. 
 Dinnerware	Microwave-safe only. Follow manufacturer's instructions. Do not use cracked or chipped dishes. 
 Glass jars	Always remove lid. Use only to heat food until just warm. Most glass jars are not heat resistant and may break. 
 Glassware	Heat-resistant oven glassware only. Make sure there is no metallic trim. Do not use cracked or chipped dishes. 
 Oven cooking bags	Follow manufacturer's instructions. Do not close with metal tie. Make slits to allow steam to escape. 
 Paper plates and cups	Use for short-term cooking/warming only. Do not leave oven unattended while cooking. 
 Paper towels	Use to cover food for reheating and absorbing fat. Use with supervision for a short-term cooking only. 
 Parchment paper	Use as a cover to prevent splattering or a wrap for steaming. 

MATERIALS YOU CAN USE IN MICROWAVE OVEN

UTENSILS	REMARKS
 <p data-bbox="172 451 240 475">Plastic</p>	<p data-bbox="350 355 898 496">Microwave-safe only. Follow the manufacturer's instructions. Should be labeled "Microwave Safe". Some plastic containers soften, as the food inside gets hot. "Boiling bags" and tightly closed plastic bags should be slit, pierced or vented as directed by package.</p> 
 <p data-bbox="145 638 266 662">Plastic wrap</p>	<p data-bbox="350 555 898 635">Microwave-safe only. Use to cover food during cooking to retain moisture. Do not allow plastic wrap to touch food.</p> 
 <p data-bbox="132 802 279 826">Thermometers</p>	<p data-bbox="350 751 888 775">Microwave-safe only (meat and candy thermometers).</p> 
 <p data-bbox="153 962 257 986">Wax paper</p>	<p data-bbox="350 898 820 954">Use as a cover to prevent splattering and retain moisture.</p> 

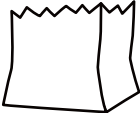
MATERIALS CAN NOT BE USED IN MICROWAVE OVEN

UTENSILS	REMARKS	
 Aluminum tray	May cause arcing. Transfer food into microwave-safe dish.	⊗
 Food carton with metal handle	May cause arcing. Transfer food into microwave-safe dish.	⊗
 Metal or metal trimmed utensils	Metal shields the food from microwave energy. Metal trim may cause arcing.	⊗
 Metal twist ties	May cause arcing and could cause a fire in the oven.	⊗
 Paper bags	May cause a fire in the oven.	⊗
 Plastic foam	Plastic foam may melt or contaminate the liquid inside when exposed to high temperature.	⊗
 Wood	Wood will dry out when used in the microwave oven and may split or crack.	⊗

PRODUCT SETTING

SETTING UP YOUR OVEN

(In case of any differences between the appliance and the pictures in this manual, the product shall prevail.)

NAMES OF MICROWAVE OVEN PARTS AND ACCESSORIES

Remove the oven and all materials from the carton and oven cavity.



Turntable Ring Assembly



Instruction Manual

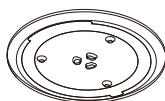

Glass turntable



Turntable Shaft

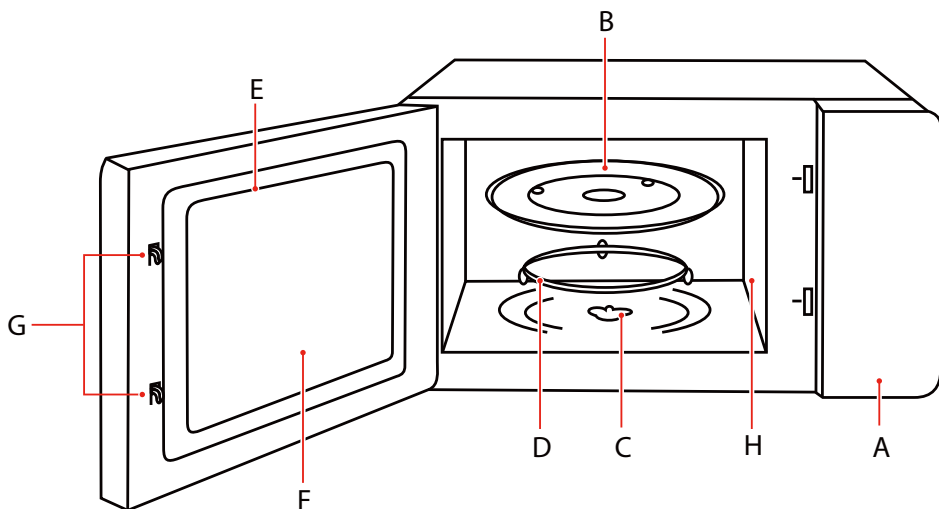

- | | |
|----------------------------|----------------------------|
| A. Control panel | E. Door assembly |
| B. Glass tray | F. Observation window |
| C. Turntable shaft | G. Safety interlock system |
| D. Turntable ring assembly | H. Waveguide cover |

SETTING UP YOUR OVEN

TURNTABLE INSTALLATION

Clean the cooking compartment and place the turntable.

For new installations, make sure all packaging and shipping tape has been removed from the turntable shaft.

Before using the appliance to prepare food for the first time, you will need to put the turntable in place correctly. You must clean the cooking compartment and accessories. You can also refer them to the cleaning section.

How to put the turntable in place:

1. Place the turntable ring assembly ③ into the recess in the cooking compartment.
2. Place the glass tray ① on the turntable ring assemblies ③. Fit the raised, curved lines in the center of the glass tray bottom between the three spokes of the shaft. Make sure that the glass tray ① engages in the turntable shaft ② in the centre of the cooking compartment floor. The rollers on the shaft should fit inside the turntable bottom ridge.

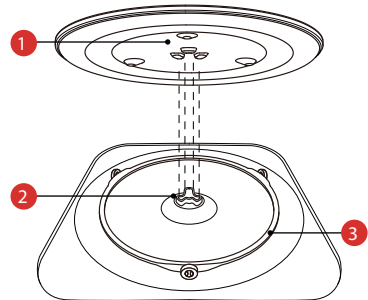

- 1) Glass Tray
- 2) Turntable Shaft
- 3) Turntable Ring Assembly

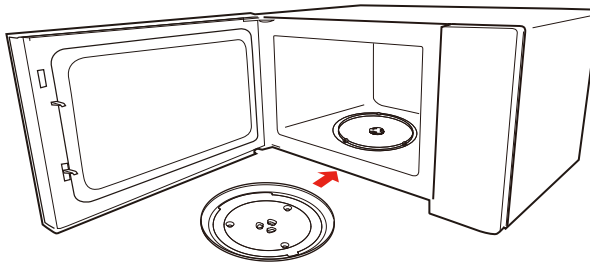

NOTE

- Never use the appliance without the turntable. Make sure that it is properly engaged. The turntable can turn clockwise or anti-clockwise.
- Never place the glass tray upside down. The glass tray should never be restricted.
- Both glass tray and turntable ring assembly must always be used during cooking.
- All food and containers of food are always placed on the glass tray for cooking.
- Never restrict the movement of the turntable.
- If glass tray or turntable ring assembly cracks or breaks, contact your nearest authorized service center.

COUNTERTOP INSTALLATION

Remove all packing material and accessories. Examine the oven for any damage such as dents or broken door. Do not install if oven is damaged.

Cabinet: Remove any protective film found on the microwave oven cabinet surface. Do not remove the waveguide cover that is attached to the oven cavity to protect the magnetron.

INSTALLATION

1. Select a level surface that provide enough open space for the intake and/or outlet vents.
 - a. The minimum installation height is 85cm.
 - b. The rear surface of appliance shall be placed against a wall. Leave a minimum clearance of 30cm above the oven. A minimum clearance of 20cm is required between the oven and any adjacent walls.
 - c. Do not remove the legs from the bottom of the oven.
 - d. Blocking the intake and/or outlet openings can damage the oven.
 - e. Place the oven as far away from radios and TV as possible. Operation of microwave oven may cause interference to your radio or TV reception.

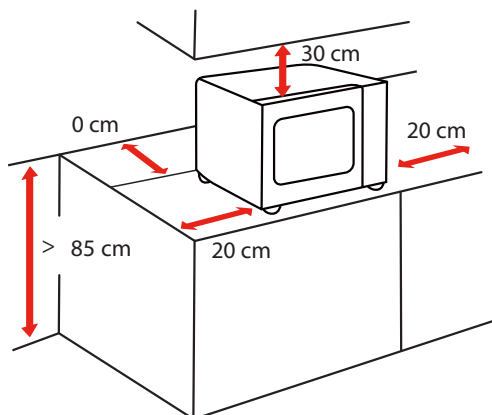

SIDE	DISTANCE CM
Top	30cm
Left	20cm
Right	20cm
Behind	0cm
Front	Open

2. Plug microwave oven into a standard household outlet. Be sure the voltage and the frequency is the same as the voltage and the frequency on the rating label.



NOTE

- Do not install oven over a range cooktop or other heat-producing appliance. If installed near or over a heat source, the oven could be damaged and the warranty would be void.

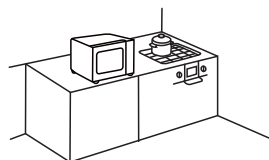

The accessible surface may be hot during operation

INSTRUCTION FOR USE

BEFORE USING FOR THE FIRST TIME

It is normal that the oven may produce unpleasant odors when it is used for the first time.

This section tells you what you need to do before using your microwave to prepare food for the first time. Read the section entitled "**PRODUCT SAFETY**" beforehand.

Before you can use your new appliance, you will need to put the turntable in place correctly. You must also clean the cooking compartment and accessories.





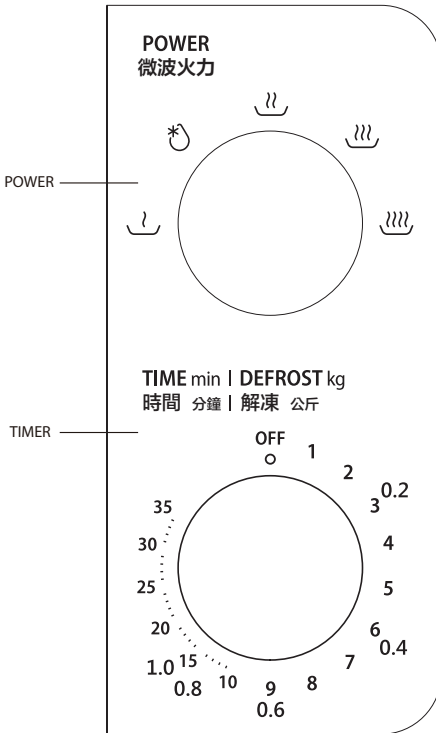

NOTE

- Never use the appliance without the turntable.
- Make sure that it is properly engaged. The turntable can turn clockwise or anti-clockwise.

OPERATION



- 1.To set cooking power by turning the power knob to desired level.
- 2.To set the time of cooking by turning the timer knob to desired time per your food cooking guide.
- 3.The microwave oven will automatically start cooking after power level and time are set.
- 4.When the cooking time is up, the unit will "Dong" to stop.
- 5.If the unit is not in use, always set time to "0 ."

Function/Power	Output	Application
Low 	17% micro.	soften ice cream
Mid Low (Defrost) 	33% micro.	soup stew, soften butter or defrost
Mid 	55% micro.	stew, fish
Mid High 	77% micro.	rice, fish, chicken, ground meat
High 	100% micro.	reheat, milk, boil water, vegetables, beverage



NOTE

When removing food from the oven, please ensure that the oven power is switched off by turning the timer switch to 0(zero). Failure to do so, and operating the microwave oven without food in it, can result in overheating and damage to the magnetron.

CLEANING AND MAINTENANCE

CLEANING

With good care and cleaning, your appliance will retain its appearance and remain fully functioning for a long time to come. We will explain here how you should correctly care for and clean your appliance.



WARNING

- Scratched glass in the appliance door may develop into a crack. Do not use a glass scraper, sharp or abrasive cleaning aids or detergents.
- The surface of the appliance may become damaged if it is not cleaned properly. Microwave energy may escape. Clean the appliance on a regular basis, and remove any food remnants immediately.
- Do not immerse the appliance in water or clean under a jet of water.

Cleaning agent

To ensure that the different surfaces are not damaged by using the wrong cleaning agent, observe the information in the table. Wash new sponge cloths thoroughly before use.

Do not use:



Harsh or abrasive cleaning agents



Metal or glass scrapers to clean the door panels



Metal or glass scrapers to clean the door seal



Hard scouring pads or sponges



Cleaning agents with a high alcohol content

APPLIANCE FRONT

Hot soapy water:

Clean using a dish cloth and then dry with a soft cloth. Do not use metal or glass scrapers for cleaning.

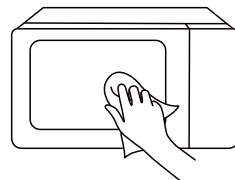

APPLIANCE FRONT WITH STAINLESS STEEL

Hot soapy water:

Clean using a dish cloth and then dry with a soft cloth. Remove splashes and patches of limescale, grease, starch and albumin immediately. Corrosion can form under these patches or splashes. Do not use glass cleaners or metal or glass scrapers for cleaning.

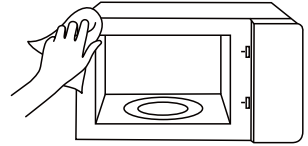

COOKING COMPARTMENT MADE OF STAINLESS STEEL

Hot soapy water or vinegar solution:

Clean using a dish cloth and then dry with a soft cloth. Do not use oven spray or any other aggressive oven cleaners or abrasive materials. Scouring pads, rough sponges and pan cleaners are also unsuitable. These items scratch the surface. Allow the interior surfaces to dry completely.

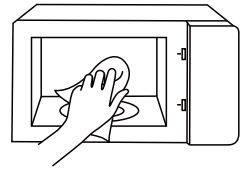

RECESS IN THE COOKING COMPARTMENT

Damp cloth:

Water must not be allowed to run into the appliance through the turntable drive. Dry the turntable drive with a cloth.

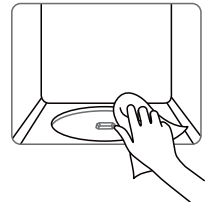

TURNTABLE AND ROLLER RING

Hot soapy water:

When placing the turntable back into its recess, it must engage properly.

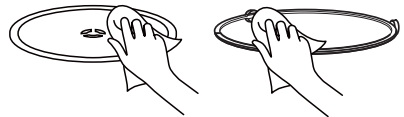

DOOR PANELS

Glass cleaner:

Clean with a dish cloth. Do not use glass scrapers.

TROUBLE SHOOTING

Normal

Microwave oven interfering
TV reception

Radio and TV reception may be interfered when microwave oven operating. It is similar to the interference of small electrical appliances, like mixer, vacuum cleaner, and electric fan. It is normal.

Dim oven light

In low power microwave cooking, oven light may become dim. It is normal.

Steam accumulating on
door, hot air out of vents

In cooking, steam may come out of food. Most will get out from vents. But some may accumulate on cool place like oven door. It is normal.

Oven started accidentally
with no food in.

It is forbidden to run the unit without any food inside. It is very dangerous.

Trouble

Possible Cause

Remedy

Oven cannot be started.	(1) Power cord is not plugged in tightly.	Unplug. Then plug again after 10 seconds.
	(2) Fuse blowing or circuit breaker works.	Replace fuse or reset circuit breaker (repaired by professional personnel of our company)
	(3) Trouble with outlet.	Test outlet with other electrical appliances.
Oven does not heat.	(4) Door is not closed well.	Close door well.



According to Waste of Electrical and Electronic Equipment (WEEE) directive, WEEE should be separately collected and treated. If at any time in future you need to dispose of this product please do NOT dispose of this product with household waste. Please send this product to WEEE collecting points where available.

#DetailsMatter