

TOSHIBA

燒烤微波爐 使用說明書

型號：

MV-AG21TF(BK)

使用微波爐前請仔細閱讀說明書，並妥善保存。
如按本說明書操作，微波爐能為您提供長期的優質服務。

妥善保存本說明書

Microwave Oven with Grill Function INSTRUCTION MANUAL

Model:

MV-AG21TF(BK)

Read these instructions carefully before using your microwave oven, and keep it carefully.

If you follow the instructions, your oven will provide you with many years of good service.

SAVE THESE INSTRUCTIONS CAREFULLY

中文

English

目錄

目錄.....	3
注意事項.....	4
產品規格.....	4
重要安全說明.....	5-8
清潔.....	9
器具.....	9-10
配件與安裝.....	11-12
控制面板.....	13
操作	
時鐘設定.....	14
微波烹調.....	14
燒烤或混合烹調.....	15
快速啟動.....	16
按時解凍.....	16
按重解凍.....	16
計時器.....	17
自動功能表.....	17
多段火力烹調.....	19
查詢功能.....	19
兒童鎖功能.....	19
轉盤重置功能.....	19
故障排除.....	20

注意事項

避免可能暴露於過多微波能量的注意事項

- (a) 請勿嘗試在打開門的情況下操作微波爐，否則可能暴露於過多微波能量而產生有害的影響。重要的是不要打破或篡改安全鎖。
- (b) 不要在微波爐正面和門之間放置任何物體，或者讓清潔殘渣積聚在密封條上。
- (c) 警告：如果爐門或門密封條損壞，必須經過合格人員維修才能使用。

附錄

如果產品沒有保持良好的清潔狀態，其表面質量可能會下降，以及影響產品的使用壽命，並導致危險的情況。

產品規格

型號：	MV-AG21TF(BK)
額定電壓：	230-240V~50Hz
額定輸入功率（微波）：	1250-1320W
額定輸出功率（微波）：	800-850W
額定輸入功率（燒烤）	1000-1050W
微波爐容量：	21 L
轉盤直徑：	φ 255mm
外形尺寸（寬×深×高）：	462x381x284mm
淨重：	約12.59kg

重要安全說明警告

為了降低使用產品時發生火災，觸電，人身傷害或暴露過多微波爐能量的風險，請遵循以下基本預防措施，包括：

1. 閱讀並遵循“避免接觸過多微波能量的預防措施”部分的具體說明。
2. 本電器可供肢體、感官或精神能力較弱或缺乏經驗和知識的人員（包括兒童）使用，前提是有負責其安全的人員進行監督或指導。
3. 應監督兒童以避免玩耍本電器。
4. 如果電源線損壞，則必須由製造商、其服務代理商或具有類似資格的人員進行更換，以免造成危險。
5. 警告：在更換燈泡之前確保電器已關閉，以避免造成觸電。
6. 警告：需要取下微波能量防護蓋的任何服務或維修操作必須由有資格的人員執行。
7. 警告：不得在密封容器中加熱液體和其他食物，否則容易發生爆炸。

8. 在塑膠或紙容器中加熱食物時，請密切注意微波爐，因為可能會著火。
9. 僅使用適合在微波爐中使用的器皿。
10. 如果冒煙，請關閉電源或拔下電器插頭並保持爐門關閉以撲滅火焰
11. 微波加熱飲料會導致延遲沸騰，因此在處理容器時必須小心。
12. 食用前應先攪拌或搖晃奶瓶和嬰兒食品罐的內容物並檢查溫度，以免燙傷。
13. 應定期清潔微波爐並清除所有食物殘渣。
14. 未能保持微波爐清潔可能會導致表面劣化，從而對電器的使用壽命產生不利影響，並可能導致危險情況。
15. 僅使用推薦用於此微波爐的溫度探頭（適用於配有使用溫度感應探頭的設備的微波爐。）
16. 必須在裝飾門打開的情況下操作微波爐（適用於帶裝飾門的微波爐。）
17. 本電器適用於家庭和類似場景，例如：
 - 商店，辦公室和其他工作環境中的員工廚房區域；
 - 酒店、汽車旅館、家庭旅館環境中的顧客；
 - 農舍
 - 食宿型酒店。

18. 微波爐用於加熱食物和飲料。乾燥食物或衣服以及加熱保暖墊、拖鞋、海綿、濕布和類似物品可能會導致受傷、灼燒或火災。
19. 該設備旨在獨立使用。
20. 電器背面應靠牆放置。
21. 電器運行時，可觸及表面的溫度可能很高。
22. 警告：當電器在組合模式下運行時，兒童只能在成人監督下使用微波爐，以免燙傷。
23. 請勿在微波爐中加熱帶殼的雞蛋和整個煮熟的雞蛋，否則可能會爆炸，甚至是在微波加熱結束後。
24. 不得將電器安裝在裝飾門後面，以免過熱。（不適用於帶裝飾門的電器。）
25. 微波烹飪時請勿使用金屬容器盛放食物和飲料。
26. 請勿使用蒸汽清潔器清潔電器。
27. 不得通過外部計時器或單獨的遙控系統來操作電器。
28. 微波爐除非在櫃子裡經過測試，否則不得放在櫃子裡。

仔細閱讀並保留作將來參考

減少對接地安裝人員造成傷害風險

危險

觸電危險

觸摸一些內部部件會導致嚴重的人身傷害或死亡。請勿拆卸本電器。

警告

觸電危險

接地不當會導致觸電。

在電器安裝好並接地後方可插上插座。

本電器必須接地。若發生電氣短路，接地為電流提供電流外泄線路，以降低觸電的風險。本電器配有一根帶有接地插頭和接地線的電線。插頭必須插到妥善安裝和接地的插座上。

若未完全理解接地說明，或者對電器是否正確接地存在疑問，請諮詢有資格的電工或維修人員。如需使用延長線，僅可使用3線延長線。

1. 所提供電源線較短，以減少因長電源線纏結或絆倒而造成的風險。
2. 如使用長電線或延長線：
 - 1) 電線組或延長線的標示的額定功率應至少等同於電器的額定功率。
 - 2) 延長線必須是接地型3線電線。
 - 3) 應將長電線妥善收納，使其不會懸垂在櫃檯或桌面，以防兒童可將其拉上或被其無意絆倒。

清潔

務必拔下電器的電源插頭。

1. 使用後，用略濕抹布清潔微波爐內部。
2. 用肥皂水按常規方法清洗配件。
3. 門框、密封件及周邊髒物須用濕布小心清理。
4. 請勿使用粗糙的摩擦性清潔工具或鋒利的金屬刮刀清潔爐門玻璃，可能會刮傷玻璃表面，導致玻璃破碎。
5. 清潔小貼士：為了更容易清潔食物接觸到的內壁，將半個檸檬放入碗中，加入300毫升（1/2品脫）水，用100%微波功率加熱10分鐘。再用柔軟乾燥的抹布將微波爐擦乾淨。

器具

警告

人身傷害的危險

除有資格人士外的任何人進行涉及拆卸防微波能量外蓋的任何服務或維修工作均為危險行為。請參閱“可在微波爐中使用或避免在微波爐中使用的材質”的說明。某些非金屬器具用於微波加熱可能不安全。如有疑問，您可以按照下面的步驟對存在疑問的器具進行測試。

器具測試：

1. 在微波爐適用的容器中加入一杯冷水（250毫升），同時放入存在疑問的器具。
2. 用最大功率烹調1分鐘。
3. 仔細觸摸一下器具。如空器具發熱，請勿將其用於微波烹調。
4. 烹調時間勿超過1分鐘。

可用於微波爐的材質

器具	備註
白朗寧餐具	遵照生產商的指示。白朗寧餐具的底部須至少比轉盤高出3/16英寸(5mm)。使用不當可能導致轉盤損壞。
整套餐具	僅限微波適用。遵照生產商的指示。請勿使用有裂縫或有缺口的餐具。
玻璃罐	務必移除蓋子。僅用於加熱食物直到剛變熱。大多數玻璃瓶都不耐熱，可能會破裂。
玻璃器皿	僅使用耐熱烤箱玻璃器皿。確保沒有無金屬飾邊。請勿使用有裂縫或有缺口的餐具。
微波爐烹調袋	遵照生產商的指示。請勿使用金屬套件。留小縫讓蒸汽逸出。
紙盤和紙杯	僅用於短時烹調/加熱。烹調時微波爐需有人照看。
紙巾	用於覆蓋食物，進行重新加熱和吸收脂肪。在監護下使用，僅用於短時烹調。
烤盤紙	用於覆蓋食物，以防止濺出或進行包裹蒸制。
塑膠	僅限微波適用。遵照生產商的指示。應標明“微波適用”。某些塑膠容器會隨著其中食物的變熱而變軟。“蒸煮袋”和密封的塑膠袋應按照包裝上的指示進行開小縫、穿孔或通風。
保鮮膜	僅限微波適用。用於烹調時覆蓋食物以保持水分。請勿讓保鮮膜接觸食物。
蠟紙	用於覆蓋食物，以防止濺出和保持水分。

微波爐中應避免使用的材質

器具	備註
鋁盤	可能會引起電弧作用。將食物轉移至微波適用餐具中。
金屬把手食品盒	可能會引起電弧作用。將食物轉移至微波適用餐具中。
金屬或金屬飾邊的器具	金屬使食物免受微波能量的傷害。金屬飾邊可能引起電弧作用。
金屬紮帶	可能會引起電弧作用，並可能導致烤箱起火。
紙袋	可能導致微波爐起火。
泡沫塑料	泡沫塑料在高溫下會融化或污染內部的液體。
木質	木材在微波爐中使用會變乾，可能會裂開或產生裂縫。

配件與安裝

微波爐配件

微波爐零件和配件名稱

將微波爐和所有材料從紙箱和爐腔中取出。

微波爐配有以下配件：

玻璃托盤 1個

轉盤環組件 1個

轉盤軸 1個

烤架 1個

說明書 1份

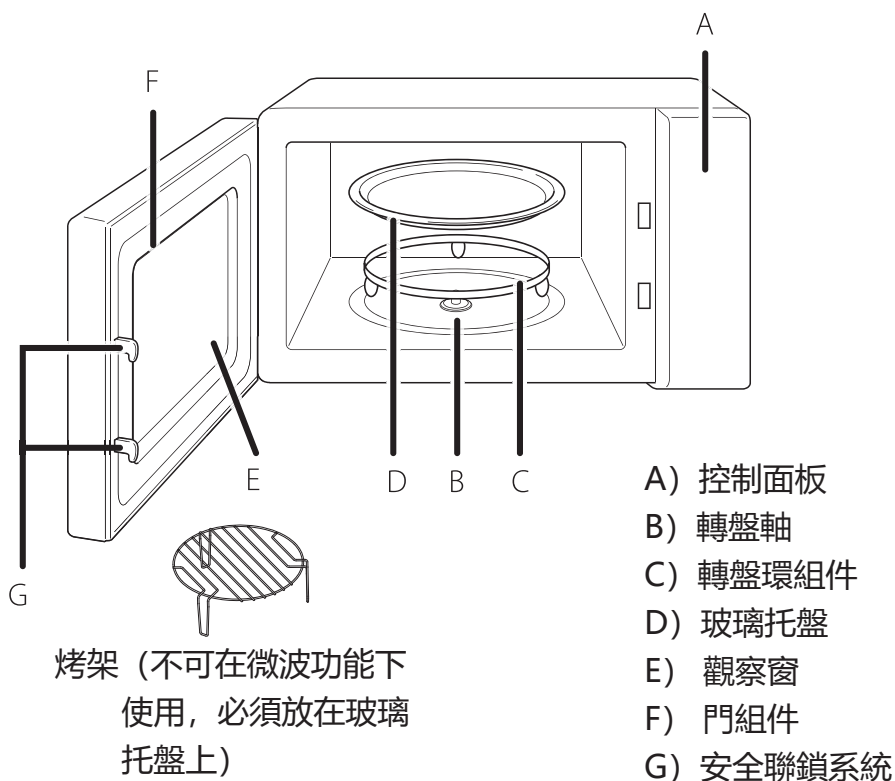

轉盤安裝

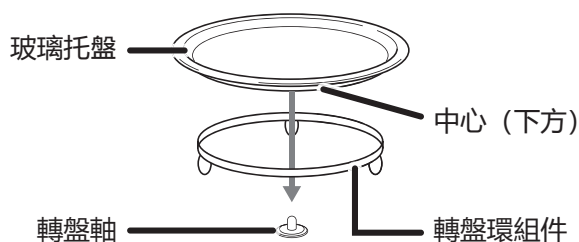

- 切勿將玻璃托盤倒置。根據圖示把玻璃托盤依正確方向放在轉盤環上，玻璃托盤應可順暢地轉動。
- 烹調時必須使用玻璃托盤和轉盤環組件。
- 所有食物和食物容器必須放在玻璃托盤上進行烹調。
- 如果玻璃托盤或轉盤環組件出現裂縫或斷裂，請聯繫您就近的授權服務中心。

檯面安裝

取出所有包裝材料和配件。檢查微波爐是否有任何損壞，如凹痕或爐門破損。如果微波爐損壞，請勿安裝。

機身外殼：拆下微波爐機身外殼表面的任何保護膜。

不要取下貼在微波爐爐腔的淺棕色雲母片，這是以保護磁控管。

安裝

1. 選擇一個為進氣口和/或出風口提供足夠開放空間的水平面。

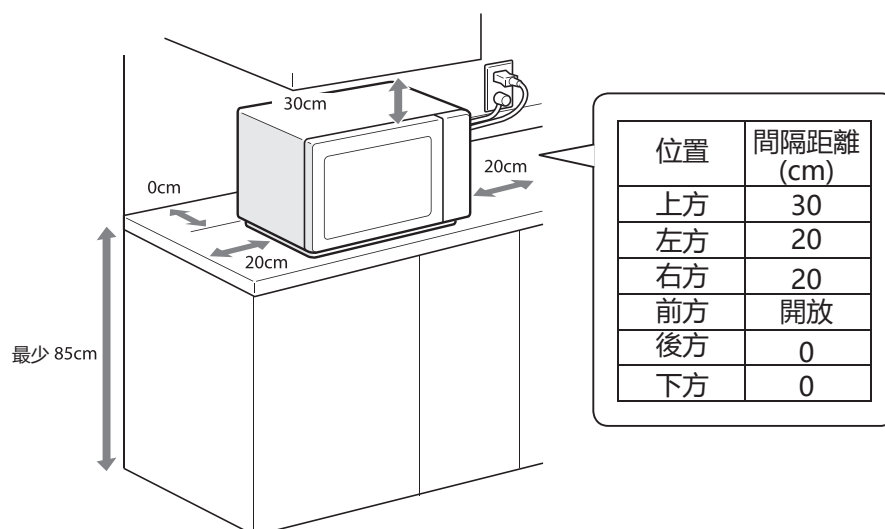

- (1) 最小安裝高度為85厘米。
 - (2) 產品應放置於貼近牆壁位置。
在微波爐上方留出最少30厘米的距離，微波爐和任何相鄰牆壁之間需要距離最少20厘米。
 - (3) 請勿從微波爐底部取下爐腳。
 - (4) 阻塞進氣口和/或出口可能會損壞微波爐。
 - (5) 將微波爐盡可能遠離收音機和電視機。微波爐的操作可能會對您的收音機或電視接收造成干擾。
2. 將微波爐插入標準家庭插座。確保電壓和頻率與額定值標籤上的電壓和頻率相同。

警告：不要在煮食爐灶或其他發熱產品上安裝微波爐。如果安裝在熱源附近或之上，微波爐可能會損壞，保修將無效。

在運行期間，可觸及的表面
可能會發熱。





控制面板



操作

1. 時鐘設定



微波爐通電後，螢幕顯示“0:00”，蜂鳴器鳴響一次。

- 1) 按下“計時器/時鐘”兩次選擇時鐘功能，小時數位將閃爍。
- 2) 轉動“”調節小時數位，輸入時間應在0-23之間。
- 3) 按下“開始/+30秒”，分鐘數字將閃爍。
- 4) 轉動“”調節分鐘數字，輸入時間應在0-59之間。
- 5) 按下“開始/+30秒”完成時鐘設定。“:”將閃爍，時間亮起。
- 6) 如果需要重置時鐘，請重複步驟1至步驟5。



注：1) 若不設定時鐘，則通電時時鐘不工作。

- 2) 在時鐘設定過程中，若您按下“停止/取消”鍵，或者在1分鐘內無操作，微波爐會自動回到之前的狀態。

2. 微波烹調

按一下“微波”鍵，螢幕顯示“800w”，“00:00”亮起。多次按下“微波”或轉動“”選擇所需功率，每按一次依次顯示“800w”、“600w”、“400w”、“200w”、“100w”。再按下“開始/+30秒”確認，轉動“”設置烹調時間，範圍為從0:05到95:00。按下“開始/+30秒”開始烹調。

例子：使用600W微波功率烹調20分鐘，您可以按照以下步驟操作微波爐。

- 1) 按一次“微波”，螢幕將顯示“800w”。
- 2) 再按一次“微波”或轉動“”選擇混合600W的烹調功率。
- 3) 按下“開始/+30秒”確認，螢幕將顯示“600w”。
- 4) 轉動“”調整烹調時間，直到螢幕顯示“20:00”為止。
- 5) 按下“開始/+30秒”開始烹調。



注：預設開關調整時間的幅度為：

0---1 分鐘	:	5 秒
1---5 分鐘	:	10 秒
5---10 分鐘	:	30 秒
10---30 分鐘	:	1分鐘
30---95 分鐘	:	5分鐘



“微波” 面板說明

順序	顯示	微波功率
1	800w	100%
2	600w	80%
3	400w	50%
4	200w	30%
5	100w	10%

3. 燒烤或混合烹調

在待機狀態下，按一下“燒烤/混合”，螢幕將顯示“G”。多次按下“燒烤/混合”或轉動“”選擇所需功率，每按一次依次顯示“G”、“C1”、“C2”。再按下“開始/ + 30秒”確認，轉動“”設置烹調時間，範圍為從0:05到95:00。按下“開始/+ 30秒”開始烹調。



例子：使用55%微波功率和45%的燒烤功率（C1）烹調10分鐘，您可以按照以下步驟操作微波爐。

- 1) 按一下“燒烤/混合”，螢幕將顯示“G”。
- 2) 多次按下“燒烤/混合”或轉動“”選擇混合1(C1)模式。
- 3) 按下“開始/+ 30秒”確認，螢幕將顯示“C1”。
- 4) 轉動“”調整烹調時間，直到螢幕顯示“10:00”為止。
- 5) 按下“開始/+ 30秒”開始烹調。

“燒烤/混合” 面板說明

順序	顯示	微波功率	燒烤功率	建議加熱器皿及配件
1	G	0%	100%	跟機燒烤架或烤盤
2	C1	55%	45%	跟機燒烤架或烤盤
3	C2	36%	64%	跟機燒烤架或烤盤

4. 快速啟動 (建議加熱器皿及配件:微波安全器皿加蓋或保鮮膜覆蓋)

- 1) 在多段火力烹調過程中，每按一次“開始/+30秒”可增加30秒的烹調時間。解凍階段無法增加時間。
- 2) 在微波、燒烤、混合烹調或按時間解凍狀態中，每按一次“開始/+30秒”可增加30秒的烹調時間。
- 3) 在待機狀態中，向左轉動 “” 設置烹調時間，100%微波功率“800w”亮起，“00:00”閃爍。然後向左或向右轉動 “” 設置烹調時間（或按下“開始/+30秒”設置30秒烹調時間，微波爐自動開始烹調）。選擇烹調時間後，按下“開始/+30秒”開始烹調。

5. 按時解凍 (建議加熱器皿及配件:微波安全器皿)

- 1) 按一下“解凍”鍵，微波爐顯示解凍功率“240w”，“00:00”閃爍提醒您輸入解凍時間。
- 2) 轉動 “” 選擇解凍時間。最長時間為95分鐘。
- 3) 按下“開始/+30秒”開始解凍。解凍功率無法改變。

6. 按重解凍 (建議加熱器皿及配件:微波安全器皿)

- 1) 按兩次“解凍”鍵，“100”閃爍，提醒您輸入解凍重量。
- 2) 轉動 “” 選擇食物重量，範圍為100g至1500g。（每100g為每次轉動單位）
- 3) 按下“開始/+30秒”開始解凍。

7. 計時器

- 1) 按一下“計時器/時鐘”，螢幕將顯示00:00。
- 2) 轉動“”輸入正確的時間。（最長烹調時間為95分鐘。）
- 3) 按下“開始/+30秒”確認。
- 4) 廚房計時器時間到，蜂鳴器鳴響5次，螢幕將顯示“End”。

注：1) 計時器適用於微波爐以外的其他煮食方法的時間倒數。例如用作明火蒸魚的計時器。

2) 計時器工作時無法查詢當前時間。

3) 在計時器工作期間，按下“停止/取消”可停止計時器，微波爐回到待機狀態。

8. 自動功能表



向右轉動“”選擇功能表，將顯示“A-1”至“A-12”。

按下“開始/+30秒”確認。

轉動“”選擇功能表中的預設重量。

- 4) 按下“開始/+30秒”開始烹調。

示例：如您想使用“自動功能表”烹調100g意大利麵。

- 1) 順時針“”直到顯示“A-6”。
- 2) 按下“開始/+30秒”確認。
- 3) 轉動“”選擇麵的重量直到顯示“100”。
- 4) 按下“開始/+30秒”開始烹調。

自動功能表



自動功能(向右旋轉)	建議加熱器皿及配件	重量	顯示	烹調時間 (分鐘)
A-1 再加熱 (杯)	微波安全器皿	1杯	1	1:30分鐘
		2杯	2	2:30分鐘
		3杯	3	3:30分鐘
A-2 烤寬麵條	跟機燒烤架或烤盤	250 g	250 g	12分鐘
		500 g	500 g	20分鐘
A-3 炒雞蛋	微波安全器皿	1(50g)	1	1:40分鐘
		2(100g)	2	3分鐘
		3(150g)	3	4分鐘
A-4 烤馬鈴薯	跟機燒烤架或烤盤	1	1	15分鐘
		2	2	24分鐘
		3	3	30分鐘
A-5 烤麵包片	跟機燒烤架或烤盤	80 g	80	10分鐘
A-6 意大利麵	微波安全器皿加蓋 或保鮮膜覆蓋	50克 (450 克水)	50 g	18分鐘
		100克 (800 克水)	100 g	20分鐘
		150克 (1200 克水)	150 g	22分鐘
A-7 披薩	跟機燒烤架或烤盤	200 g	200 g	10分鐘
		400 g	400 g	15分鐘
A-8 烤煙肉	微波安全器皿	1片	1	1分鐘
		2片	2	1:50分鐘
		3片	3	2:40分鐘
		4片	4	3:30分鐘
		5片	5	4:20分鐘
		6片	6	5:10分鐘
A-9 烤蔬菜	跟機燒烤架或烤盤	500 g	500 g	60分鐘
A-10 再加熱蔬菜湯	微波安全器皿加蓋 或保鮮膜覆蓋	1杯	1	1:50分鐘
		2杯	2	3:30分鐘
		3杯	3	5分鐘
A-11 烤三文魚	跟機燒烤架或烤盤	300 g	300 g	15分鐘
A-12 爆谷	微波安全器皿	100 g	100 g	2:30分鐘

9. 多段火力烹調 (建議加熱器皿及配件: 微波安全器皿)

至多可設置2個烹調火力。在多段火力烹調中，若其中一個階段為解凍階段，則該階段自動成為第一個階段。

注：計時器和自動功能表無法在多段火力烹調功能下工作。快速啟動可設置為多段火力烹調中的一個。

示例：若您想解凍食物5分鐘，然後用600w的微波功率加熱7分鐘，操作如下：

- 1) 按一次“解凍”鍵，微波爐顯示“240w”，“00:00”閃爍。
- 2) 轉動“”要選擇解凍時間，直到螢幕顯示“5:00”為止。
- 3) 按一下“微波”，螢幕顯示“800w”。
- 4) 再按一次“微波”或轉動“”選擇600w的烹調功率。
- 5) 按下“開始/+30秒”確認，螢幕將顯示“600w”。
- 6) 轉動“”調整烹調時間，直到螢幕顯示“7:00”為止。
- 7) 按下“開始/+30秒”開始烹調，第一階段蜂鳴器鳴響一次，解凍時間開始倒數。蜂鳴器再次鳴響，進入第二階段烹調。烹調完成後，蜂鳴器鳴響五次。

10. 查詢功能

在烹調狀態下，按下“時鐘”查詢時間，時間顯示3秒。

11. 兒童鎖功能

鎖定：在待機狀態下，按“停止/取消”鍵3秒，長鳴“嗶”聲表示進入兒童鎖狀態。鎖定指示燈亮，如已設置，則當前時間將顯示。

退出鎖定：在鎖定狀態下，按“停止/取消”鍵3秒，長鳴“嗶”聲表示退出兒童鎖狀態。

12. 轉盤重置功能

烹調完成後，若轉盤不在開始位置，則將進入轉盤復位功能。此時，照明燈、風扇和轉盤都在工作“”將動態顯示。轉盤復位後，微波爐停止烹調，提醒烹調完畢。

注：

1. 此功能只適用於一次性完成的烹調。若在烹調過程中暫停或打開爐門，則此次烹調無法進入轉盤復位功能。
2. 在重定模式下，開門或按下“停止/取消”按鈕，微波爐將回到待機狀態。
3. 定位精度：烹調時間在5分鐘以內，且轉盤角度-30度到30度範圍內。

故障排除

正常狀況

微波爐干擾電視接收	當微波爐運作時，收音機和電視接收可能會受到干擾。它類似於小電器的干擾，如攪拌機，吸塵器和電風扇。這是正常的。
昏暗的爐燈	在低微波火力烹調中，微波爐燈可能變暗。這是正常的。
蒸氣積聚在門上，熱空氣從通風口排出	在烹調中，蒸氣可能會從食物中產生出來。大部分濕氣會從通風口排出。但有些可能會在陰涼處如爐門上積聚。這是正常的。
微波爐意外地在沒有食物的情況下開始運行	禁止在內部沒有食物的情況下運行。這是非常危險的。

故障	可能的原因	補救
微波爐不運行	(1) 電源線沒有插好。	拔下電源線，然後10秒後重新插上。
	(2) 保險絲熔斷或斷路器啟動。	更換保險絲或重設斷路器(由本公司專業人員進行維修)。
	(3) 插座出現故障。	利用其他電器測試插座。
微波爐不能加熱	(4) 門未關妥。	關妥爐門。
微波爐操作時，玻璃轉盤發出噪音	(4) 髒污滾輪和微波爐底部藏有食物殘渣。	請參考“清潔”部分清潔髒污部分。

TOSHIBA

燒烤微波爐 使用說明書

型號:

MV-AG21TF(BK)

使用微波爐前請仔細閱讀說明書，並妥善保存。
如按本說明書操作，微波爐能為您提供長期的優質服務。

妥善保存本說明書

Microwave Oven with Grill Function INSTRUCTION MANUAL

Model:

MV-AG21TF(BK)

Read these instructions carefully before using your microwave oven, and keep it carefully.

If you follow the instructions, your oven will provide you with many years of good service.

SAVE THESE INSTRUCTIONS CAREFULLY

中文

English

CONTENTS

CONTENTS	23
PRECAUTIONS.....	24
SPECIFICATIONS.....	24
IMPORTANT SAFETY INSTRUCTIONS.....	25-28
CLEANING	29
UTENSILS	29-30
SET UP & INSTALLATION	31-32
CONTROL PANEL	33
OPERATION	
CLOCK SETTING.....	34
MICROWAVE COOKING	34
GRILL OR COMBI. COOKING	35
QUICK START.....	36
DEFROST BY WEIGHT	36
DEFROST BY TIME.....	36
KITCHEN TIMER.....	37
AUTO MENU	37
MULTI-STAGE COOKING.....	39
INQUIRING FUNCTION	39
LOCK-OUT FUNCTION FOR CHILDREN	39
TURNTABLE RESET FUNCTION	40
TROUBLE SHOOTING.....	41

PRECAUTIONS

PRECAUTIONS TO AVOID POSSIBLE EXPOSURE TO EXCESSIVE MICROWAVE ENERGY

- (a) Do not attempt to operate this oven with the door open since this can result in harmful exposure to microwave energy. It is important not to break or tamper with the safety interlocks.
- (b) Do not place any object between the oven front face and the door or allow cleaner residue to accumulate on sealing surfaces.
- (c) **WARNING:** If the door or door seals are damaged, the oven must not be operated until it has been repaired by a competent person.

ADDENDUM

If the apparatus is not maintained in a good state of cleanliness, its surface could be degraded and affect the life span of the apparatus and lead to a dangerous situation.

SPECIFICATIONS

Model:	MV-AG21TF(BK)
Rated Voltage:	230-240V~50Hz
Rated input Power (Microwave):	1250-1320W
Rated Output Power (Microwave):	800-850W
Rated input Power (Grill):	1000-1050W
Oven Capacity:	21L
Turntable Diameter:	Φ 255mm
Outside Dimensions (W x D x H):	462x381x284mm
Net Weight:	Approx. 12.59kg

IMPORTANT SAFETY INSTRUCTIONS

WARNING

IMPORTANT SAFETY INSTRUCTIONS

WARNING

To reduce the risk of fire, electric shock, injury to persons or exposure to excessive microwave oven energy when using your appliance, follow basic precautions, including the following:

1. Read and follow the specific: "PRECAUTIONS TO AVOID POSSIBLE EXPOSURE TO EXCESSIVE MICROWAVE ENERGY".
2. This appliance is not intended for use by persons (including children) with reduced physical, sensory or mental capabilities, or lack of experience and knowledge, unless they have been given supervision or instruction concerning use of the appliance by a person responsible for their safety.
3. Children should be supervised to ensure that they do not play with the appliance.
4. If the supply cord is damaged, it must be replaced by the manufacturer, its service agent or similarly qualified persons in order to avoid a hazard.
5. **WARNING:** Ensure that the appliance is switched off before replacing the lamp to avoid the possibility of electric shock.
6. The microwave oven is intended for heating food and beverages. Drying of food or clothing and heating of warming pads, slippers, sponges, damp cloth and similar may lead to risk of injury, ignition or fire.

7. WARNING: It is hazardous for anyone other than a competent person to carry out any service or repair operation that involves the removal of a cover which gives protection against exposure to microwave energy.
8. WARNING: Liquids and other foods must not be heated in sealed containers since they are liable to explode.
9. When heating food in plastic or paper containers, keep an eye on the oven due to the possibility of ignition.
10. Only use utensils that are suitable for use in microwave ovens.
11. If smoke is emitted, switch off or unplug the appliance and keep the door closed in order to stifle any flames.
12. Microwave heating of beverages can result in delayed eruptive boiling, therefore care must be taken when handling the container.
13. The contents of feeding bottles and baby food jars shall be stirred or shaken and the temperature checked before consumption, in order to avoid burns.
14. The oven should be cleaned regularly and any food deposits removed.
15. Failure to maintain the oven in a clean condition could lead to deterioration of the surface that could adversely affect the life of the appliance and possibly result in a hazardous situation.
16. Only use the temperature probe recommended for this oven. (for ovens provided with a facility to use a temperature-sensing probe.)

17. The microwave oven must be operated with the decorative door open. (for ovens with a decorative door.)

18. This appliance is intended to be used in household and similar applications such as:

-staff kitchen areas in shops, offices and other working environments;

-by clients in hotels, motels and other residential type environments;

-farm houses;

-bed and breakfast type environments.

19. The appliance is intended to be used freestanding.

20. The rear surface of appliances shall be placed against a wall.

21. The temperature of accessible surfaces may be high when the appliance is operating.

22. **WARNING:** When the appliance is operated in the combination mode, children should only use the oven under adult supervision due to the temperatures generated.

23. Eggs in their shell and whole hard-boiled eggs should not be heated in microwave ovens since they may explode, even after microwave heating has ended.

24. The appliance must not be installed behind a decorative door in order to avoid overheating.

(This is not applicable for appliances with decorative door.)

25. The microwave oven shall not be placed in a cabinet unless it has been tested in a cabinet.

26. Metallic containers for food and beverages are not allowed during microwave cooking.

27. The appliance shall not be cleaned with a steam cleaner.

28. The appliances are not intended to be operated by means of an external timer or separate remote-control system.

READ CAREFULLY AND KEEP FOR FUTURE REFERENCE

To Reduce the Risk of Injury to Persons Grounding Installation

DANGER

Electric Shock Hazard

Touching some of the internal components can cause serious personal injury or death. Do not disassemble this appliance.

WARNING

Electric Shock Hazard

Improper use of the grounding can result in electric shock.

Do not plug into an outlet until appliance is properly installed and grounded.

This appliance must be grounded. In the event of an electrical short circuit, grounding reduces the risk of electric shock by providing an escape wire for the electric current.

This appliance is equipped with a cord having a grounding wire with a grounding plug. The plug must be plugged into an outlet that is properly installed and grounded.

Consult a qualified electrician or serviceman if the grounding instructions are not completely understood or if doubt exists as to whether the appliance is properly grounded.

If it is necessary to use an extension cord, use only a 3-wire extension cord.

1. A short power-supply cord is provided to reduce the risks resulting from becoming entangled in or tripping over a longer cord.
2. If a long cord set or extension cord is used:
 - 1) The marked electrical rating of the cord set or extension cord should be at least as great as the electrical rating of the appliance.
 - 2) The extension cord must be a grounding-type 3-wire cord.
 - 3) The long cord should be arranged so that it will not drape over the counter top or tabletop where it can be pulled on by children or tripped over unintentionally.

CLEANING

Be sure to unplug the appliance from the power supply.

1. Clean the cavity of the oven after using with a slightly damp cloth.
2. Clean the accessories in the usual way in soapy water.
3. The door frame and seal and neighboring parts must be cleaned carefully with a damp cloth when they are dirty.
4. Do not use harsh abrasive cleaners or sharp metal scrapers to clean the oven door glass since they can scratch the surface, which may result in shattering of the glass.
5. Cleaning Tip---For easier cleaning of the cavity walls that the food cooked can touch: Place half a lemon in a bowl, add 300ml (1/2 pint) water and heat on 100% microwave power for 10 minutes. Wipe the oven clean using a soft, dry cloth.

UTENSILS

CAUTION

Personal Injury Hazard

It is hazardous for anyone other than a competent person to carry out any service or repair operation that involves the removal of a cover which gives protection against exposure to microwave energy.

See the instructions on "Materials you can use in microwave oven or to be avoided in microwave oven." There may be certain non-metallic utensils that are not safe to use for microwaving. If in doubt, you can test the utensil in question following the procedure below.

Utensil Test:

1. Fill a microwave-safe container with 1 cup of cold water (250ml) along with the utensil in question.
2. Cook on maximum power for 1 minute.
3. Carefully feel the utensil. If the empty utensil is warm, do not use it for microwave cooking.
4. Do not exceed 1 minute cooking time.

Materials you can use in microwave oven

Utensils	Remarks
Browning dish	Follow manufacturer's instructions. The bottom of browning dish must be at least 3/16 inch (5mm) above the turntable. Incorrect usage may cause the turntable to break.
Dinnerware	Microwave-safe only. Follow manufacturer's instructions. Do not use cracked or chipped dishes.
Glass jars	Always remove lid. Use only to heat food until just warm. Most glass jars are not heat resistant and may break.
Glassware	Heat-resistant oven glassware only. Make sure there is no metallic trim. Do not use cracked or chipped dishes.
Oven cooking bags	Follow manufacturer's instructions. Do not close with metal tie. Make slits to allow steam to escape.
Paper plates and cups	Use for short-term cooking/warming only. Do not leave oven unattended while cooking.
Paper towels	Use to cover food for reheating and absorbing fat. Use with supervision for a short-term cooking only.
Parchment paper	Use as a cover to prevent splattering or a wrap for steaming.
Plastic	Microwave-safe only. Follow the manufacturer's instructions. Should be labeled "Microwave Safe". Some plastic containers soften, as the food inside gets hot. "Boiling bags" and tightly closed plastic bags should be slit, pierced or vented as directed by package.
Plastic wrap	Microwave-safe only. Use to cover food during cooking to retain moisture. Do not allow plastic wrap to touch food.
Wax paper	Use as a cover to prevent splattering and retain moisture.

Materials to be avoided in microwave oven

Utensils	Remarks
Aluminum tray	May cause arcing. Transfer food into microwave-safe dish.
Food carton with metal handle	May cause arcing. Transfer food into microwave-safe dish.
Metal or metal-trimmed utensils	Metal shields the food from microwave energy. Metal trim may cause arcing.
Metal twist ties	May cause arcing and could cause a fire in the oven.
Paper bags	May cause a fire in the oven.
Plastic foam	Plastic foam may melt or contaminate the liquid inside when exposed to high temperature.
Wood	Wood will dry out when used in the microwave oven and may split or crack.

SET UP & INSTALLATION

SETTING UP YOUR OVEN

Names of Oven Parts and Accessories

Remove the oven and all materials from the carton and oven cavity.

Your oven comes with the following accessories:

Glass tray 1

Turntable ring assembly 1

Turntable Shaft 1

Grill Rack 1

Instruction Manual 1

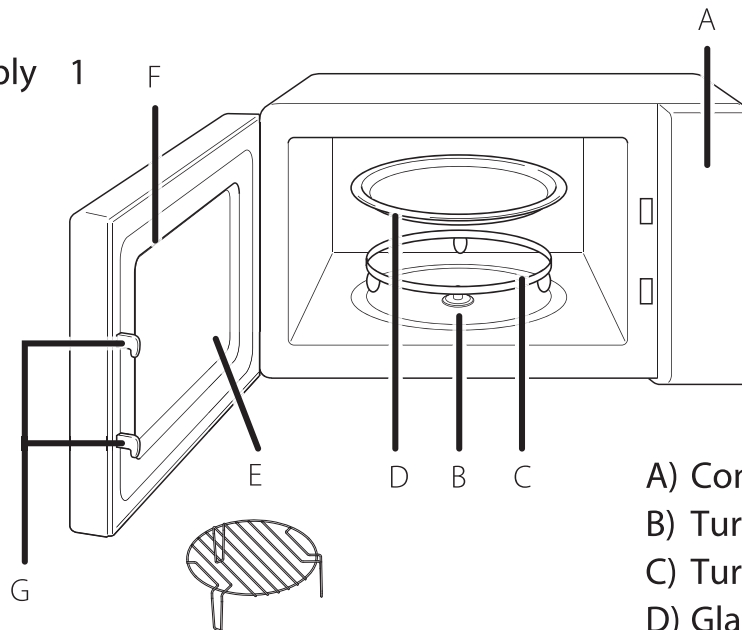

Grill Rack (Can not be used in microwave function and must be placed on the glass tray)

- A) Control panel
- B) Turntable shaft
- C) Turntable ring assembly
- D) Glass tray
- E) Observation window
- F) Door assembly
- G) Safety interlock system

Turntable Installation

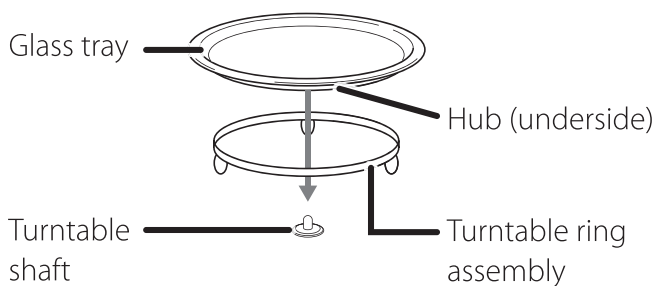

- a. Never place the glass tray upside down. Follow the instruction to place the glass tray on the turntable ring with correct direction. The glass tray should rotate smoothly.
- b. Both glass tray and turntable ring assembly must always be used during cooking.
- c. All food and containers of food are always placed on the glass tray for cooking.
- d. If glass tray or turntable ring assembly cracks or breaks, contact your nearest authorized service center.

Countertop Installation

Remove all packing material and accessories. Examine the oven for any damage such as dents or broken door. Do not install if oven is damaged.

Cabinet: Remove any protective film found on the microwave oven cabinet surface.

Do not remove the light brown Mica cover that is attached to the oven cavity to protect the magnetron.

Installation

1. Select a level surface that provide enough open space for the intake and/or outlet vents.

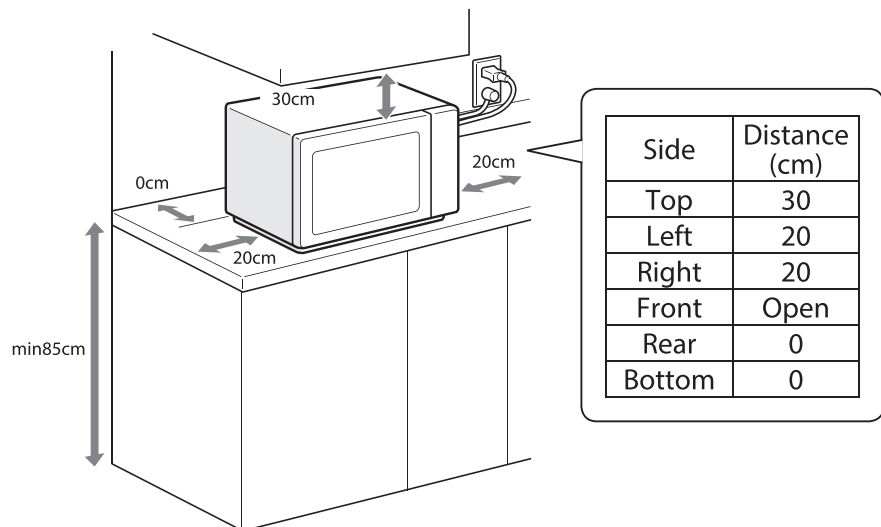

(1) The minimum installation height is 85cm.

(2) The rear surface of appliance shall be placed against a wall.

Leave a minimum clearance of 30cm above the oven, a minimum clearance of 20cm is required between the oven and any adjacent walls.

(3) Do not remove the legs from the bottom of the oven.

(4) Blocking the intake and/ or outlet openings can damage the oven.

(5) Place the oven as far away from radios and TV as possible. Operation of microwave oven may cause interference to your radio or TV reception.

2. Plug your oven into a standard household outlet. Be sure the voltage and the frequency is the same as the voltage and the frequency on the rating label.

WARNING: Do not install oven over a range cooktop or other heat-producing appliance.

If installed near or over a heat source, the oven could be damaged and the warranty would be void.

The accessible surface may be hot during operation.



CONTROL PANEL



OPERATION

1. Clock Setting

When the microwave oven is electrified, the screen will display "0:00", buzzer will ring once.

1) Press "KITCHEN TIMER/ CLOCK" twice to select clock function, the hour figures will flash.

2) Turn "  " to adjust the hour figures, the input time should be within 0--23.

3) Press " START/+30SEC.", the minute figures will flash .

4) Turn "  " to adjust the minute figures, the input time should be within 0--59.



5) Press " START/+30SEC. " to finish clock setting. ":" will flash, and the time will light.

6) If need to reset the clock, please repeat the step1 to step 5.

Note: 1) If the clock is not set, it would not function when powered.

2) During the process of clock setting, if you press " STOP/CANCEL " or if there is no operation in 1minute, the oven will go back to the previous status automatically.

2. Microwave Cooking

Press " MICROWAVE " once, the screen will display "800w" and "00:00" is light. Press "MICROWAVE" repeatedly or turn "  " to choose the power you want, and "800w", "600w", "400w", "200w ", "100w" will display for each added press. Then press "START/+30SEC." to confirm, and turn "  " to set cooking time from 0:05 to 95:00. Press "START/+30SEC." again to start cooking.

Example: If you want to use 600W microwave power to cook for 20 minutes, you can operate the oven as the following steps.

1) Press " MICROWAVE " once, the screen displays "800w".

2) Press "MICROWAVE " once again or turn "  " to choose 600W microwave power.

3) Press " START/+30SEC. " to confirm, and the screen displays "600w".

4) Turn "  " to adjust the cooking time until the oven displays "20:00".



5) Press " START/+30SEC. " to start cooking .

Note: the step quantities for the adjustment time of the coding switch are as follow:



- 0---1 min : 5 seconds
- 1---5 min : 10 seconds
- 5---10 min : 30 seconds
- 10---30 min : 1 min ute
- 30---95 min : 5 minutes

Order	Pad instructions	Display	Microwave Power
1		800w	100%
2		600w	80%
3		400w	50%
4		200w	30%
5		100w	10%

3. Grill or Combi. Cooking

Press "GRILL/COMBI" once, the screen will display "G". Press "GRILL/COMBI" repeatedly or turn  to choose the power you want, and "G", "C1". "C2" will display for each added press. Then press "START/+30SEC." to confirm, and turn  to set cooking time from 0:05 to 95:00. Press "START/+30SEC." again to start cooking.



Example: If you want to use 55% microwave power and 45% grill power(C1) to cook for 10 minutes, you can operate the oven as the following steps.

- 1) Press "GRILL/COMBI" once, the screen displays "G".
- 2) Press "GRILL/COMBI" for times or turn  to choose combi. 1 mode.
- 3) Press "START/+30SEC." to confirm, and the screen displays "C1".
- 4) Turn  to adjust the cooking time until the oven displays "10:00".
- 5) Press "START/+30SEC." to start cooking.

"GRILL/COMBI" Pad instructions

Order	Display	Microwave Power	Grill Power	Recommended heating accessories
1	G	0%	100%	Attached grill rack or pan
2	C1	55%	45%	Attached grill rack or pan
3	C2	36%	64%	Attached grill rack or pan

4. Quick Start (Recommended heating accessories: Container for microwave covered with cap or plastic wrap)

- 1) In multi-stage cooking state, each press of " **START/+30SEC.** " can increase 30 seconds cooking time. Defrosting stage cannot increase time.
- 2) In microwave, grill, combination cooking or time defrost state, each press of " **START/+30SEC.** " can increase 30 seconds of cooking time.
- 3) In waiting state, turn "  " left to set cooking time with 100% microwave power, "800w" is light, and "00:00" will flash. Then turn "  " left or right to set cooking time (or press " **START/+30SEC.** " to set 30 seconds of cooking time and the oven start cooking automatically). After choosing the cooking time, press " **START/+30SEC.** " to start cooking.

5. Defrost By Time (Recommended heating accessories: Container for microwave)

- 1) Press " **DEFROST** " once, and the oven will display the defrost power "240w" and "00:00" will flash to remind you input the defrost time.
- 2) Turn "  " to select the defrost time. The MAX time is 95 minutes.
- 3) Press " **START/+30SEC.** " to start defrosting. The defrost power cannot be changed.

6. Defrost By Weight (Recommended heating accessories: Container for microwave)

- 1) Press " **DEFROST** " twice, and "100" will flash to remind you input the defrost weight.
- 2) Turn "  " to select the weight of food from 100 to 1500 g.
- 3) Press " **START/+30SEC.** " to start defrosting.

7. Kitchen Timer



- 1) Press "**KITCHEN TIMER / CLOCK**" once, the screen will display 00:00.
- 2) Turn " " to enter the correct time. (The maximum cooking time is 95 minutes.)
- 3) Press "**START/+30SEC.** " to confirm setting.
- 4) When the kitchen time is reached, the buzzer will ring 5 times and "End" will display on the screen.

Note: 1) The Kitchen timer is for you to count down the cooking time, when the cooking is not doing by the oven.



2) The inquiry of current time cannot work when the kitchen timer is working.

3) During the working of kitchen timer, press "**STOP/CANCEL** " can cancel the kitchen timer and the oven go back to waiting state.

8. Auto Menu

- 1) Turn " " right to choose the menu, and "A-1" to "A-12" will display.
- 2) Press "**START/+30SEC.** " to confirm.
- 3) Turn " " to choose the default weight as the menu chart.
- 4) Press "**START/+30SEC.** " to start cooking.

Example: If you want to use "Auto Menu" to cook pasta for 100g.

- 1) Turn " " clockwise till "A-6" displays.
- 2) Press "**START/+30SEC.** " to confirm.
- 3) Turn " " to select the weight of pasta till "100" displays.
- 4) Press "**START/+30SEC.** " to start cooking.

The menu chart:



Menu	Recommended heating accessories	Weight	Display	Cook time (min)
A-1 Reheat cup	Container for microwave	1 cup	1	1:30 min
		2 cups	2	2:30 min
		3 cups	3	3:30 min
A-2 Lasagna	Attached Grill rack or pan	250 g	250 g	12 min
		500 g	500 g	20 min
A-3 Scrambled eggs	Container for microwave	1(50g)	1	1:40 min
		2(100g)	2	3 min
		3(150g)	3	4 min
A-4 Baked potatoes	Attached Grill rack or pan	1	1	15 min
		2	2	24 min
		3	3	30 min
A-5 Crostiti	Attached Grill rack or pan	80 g	80	10 min
A-6 Pasta	Container for microwave covered with cap or plastic wrap	50 g(with 450g water)	50 g	18 min
		100 g(with 800g water)	100 g	20 min
		150 g(with 1200g water)	150 g	22 min
A-7 Grilled Pizza	Attached Grill rack or pan	200 g	200 g	10 min
		400 g	400 g	15 min
A-8 Baked Bacon	Container for microwave	1 slice	1	1 min
		2 slices	2	1:50 min
		3 slices	3	2:40 min
		4 slices	4	3:30 min
		5 slices	5	4:20 min
		6 slices	6	5:10 min
A-9 Grilled Vegetables	Attached Grill rack or pan	500 g	500 g	60 min
A-10 Reheat vegetable soup	Container for microwave covered with cap or plastic wrap	1 cup	1	1:50 min
		2 cups	2	3:30 min
		3 cups	3	5 min
A-11 Grilled salmon	Attached Grill rack or pan	300 g	300 g	15 min
A-12 Popcorn	Container for microwave	100 g	100 g	2:30 min

9. Multi-stage cooking (Recommended heating accessories: Container for microwave)

At most 2 sections can be set for cooking. In multi-stage cooking, if one section is defrosting, then defrosting shall be placed in the first section automatically.

Note: Kitchen timer and auto menu cannot work in multi-stage cooking. Quick start can be set as one of sections in multi-stage cooking.

Example: If you want to defrost food for 5 minutes and then cook with 600W microwave power for 7 minutes, operate it as the following:

- 1) Press "**DEFROST**" once, and the oven will display "240W" and "00:00" will flash.
- 2) Turn " " to select the defrost time till "5:00" displays.
- 3) Press "**MICROWAVE**" once, the screen displays "800W".
- 4) Press "**MICROWAVE**" once again or turn " " to choose 600W microwave power.
- 5) Press "**START/+30SEC.**" to confirm, and the screen displays "600W".
- 6) Turn " " to adjust the cooking time till the oven displays "7:00".
- 7) Press "**START/+30SEC.**" to start cooking, and buzzer will sound once for the first section, defrosting time counts down. Buzzer will sound once again entering the second cooking. When cooking finishes, buzzer sounds five times.

10. Inquiring Function

In cooking state, press "**KITCHEN TIMER /CLOCK**" to inquire the time and the time will display for 3 seconds.

11. Lock-out Function for Children

Lock: In waiting state, press "**STOP/CANCEL**" for 3 seconds, there will be a long beep denoting entering the children-lock state. The lock indicator  will light and current time will display if the time has been set.

Lock quitting: In locked state, press "**STOP/CANCEL**" for 3 seconds, there will be a long "beep" denoting that the lock is released.

12. Turntable Reset Function

When cooking finished, if the turntable is not at the initial position, it will enter the turntable reset function. At this time, the lamp, fan and turntable are working, " [: :] " will dynamic display. After the turntable has reset, the screen will display " End" to remind cooking is finished.

Note:

1. This function only works for one completed cooking. If pause or open the oven door during cooking, the current cooking cannot enter the turntable reset function.
2. Under the reset state, opening the door or " STOP/CANCEL " button is pressed, the oven will go back to waiting state.
3. Position Precision: cooking time in 5 minutes and turntable degrees within the range of minus 30 degrees to 30 degrees.

TROUBLE SHOOTING

Normal

Microwave oven interfering TV reception	Radio and TV reception may be interfered when microwave oven operating. It is similar to the interference of small electrical appliance, like mixer, vacuum cleaner, and electric fan. It is normal.
Dim oven light	In low power microwave cooking, oven light may become dim. It is normal.
Steam accumulating on door, hot air out of vents	In cooking, steam may come out of food. Most will get out from vents. But some may accumulate on cool place like oven door. It is normal.
Oven started accidentally with no food in.	It is forbidden to run the until without any food inside. It is very dangerous.

Trouble	Possible Cause	Remedy
Oven can not be started.	(1) Power cord not plugged in tightly.	Unplug. Then plug again after 10 seconds.
	(2) Fuse blowing or circuit breaker works.	Replace fuse or reset circuit breaker (repaired by professional personnel of our company)
	(3) Trouble with outlet.	Test outlet with other electrical appliances.
Oven does not heat.	(4) Door not closed well.	Close door well.
Glass turntable makes noise when microwave oven operates	(5) Dirty roller rest and oven bottom.	Refer to "Maintenance of Microwave" to clean dirty parts.

PN:1617000A73699

