

使用手冊

微波蒸焗爐

蒸、焗、炸、微波4合1烹調

MX2-STR25SC(WH)

操作前請仔細閱讀本使用手冊。

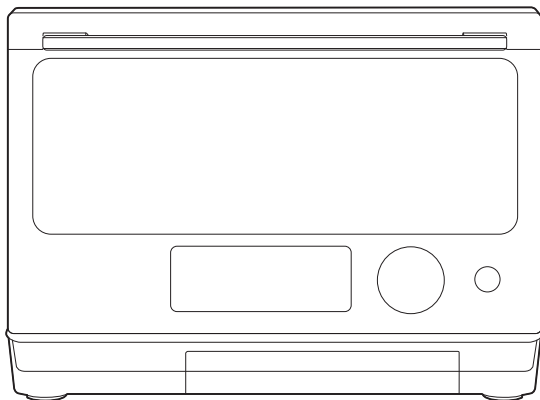

TOSHIBA

目錄

產品安全

避免接觸過量微波能量的預防措施	CN-01
規格	CN-02
重要安全說明	CN-03
減低對接地裝置人員造成傷害的風險	CN-08
清潔	CN-10
器皿	CN-11
可用於微波爐的材料	CN-12
不可用於微波爐的材料	CN-14

產品設置

微波爐零部件及配件名稱	CN-15
水箱使用	CN-16
枱面安裝	CN-17
安裝	CN-17

使用說明

首次使用前	CN-18
控制面板和功能	CN-19
1.微波烹飪	CN-20
2. 蒸煮	CN-22
3.高溫蒸氣烹飪	CN-24
4.無需預熱功能的過熱水蒸氣烤焗功能	CN-26
5.具有預熱功能的過熱水蒸氣烤焗功能	CN-27
6.具有預熱功能的烤焗烹飪	CN-29
7.無需預熱功能的烤焗烹飪	CN-30
8.具有預熱功能的空氣炸	CN-32

9. 無需預熱的空氣炸	CN-33
10. 自動菜單	CN-35
11. 無線連接	CN-39
12. 解凍	CN-40
13. 發酵	CN-42
14. 保溫	CN-44
15. 除菌	CN-45
16. 烘乾	CN-46
17. 除味	CN-47
18. 清潔	CN-48
19. 除垢	CN-49
20. 節能功能	CN-51
食譜	CN-51
常見問題	CN-52

清潔和維護

清潔	CN-53
故障排除	CN-55



注意事項

在操作本產品之前，請閱讀、理解並遵循這些說明。請務必保存本書以供日後參考。

避免接觸過量微波能量的預防措施

(a) 不要試圖在門打開的情況下操作本微波爐，因為這可能會接觸到微波能量而造成傷害。不得破壞或者更改安全聯鎖裝置。

(b) 禁止在微波爐正面和門之間放置任何物體，或在密封面上堆積土壤或清潔劑殘留物。

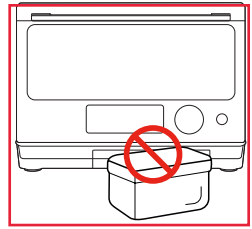

(c) **警告：**如果微波爐的門或門密封條有損，須待專業技術人員修好後，方可使用微波爐。

後附

如設備沒有保持在良好的清潔狀態下，其表面可能會退化、影響設備使用壽命，並造成危險。

規格

型號	MX2-STR25SC(WH)
額定電壓/頻率	220 V~ 50 Hz
微波輸入	1550 W
微波輸出	1000 W
烤焗	1600 W
氣炸（熱風）	2000 W
蒸氣	1500 W



注意事項

本手冊中的所有圖片僅供參考，實際購買的設備可能略有不同，請以實際產品為準。

重要安全說明



警告

為減低使用本電器時發生火災、觸電、人身傷害或接觸於過量微波能量的風險，請遵循以下基本預防措施：



閱讀並遵循以下具體內容：“**「避免接觸過量微波能量的預防措施」**”。



本電器不適合身體感到不適、精神狀態不佳智力不佳或缺乏經驗和知識的人員（包括兒童）使用，除非有負責其安全的人員對其使用進行監督或指導。



請看管好兒童，切勿讓兒童玩耍本電器。

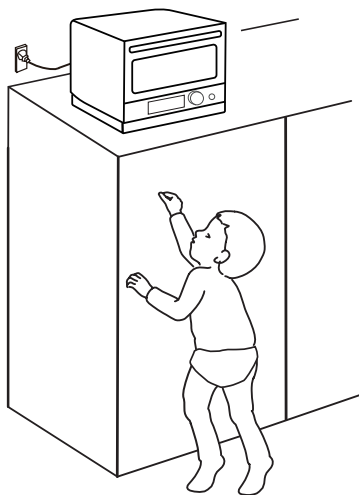



如果電源線損壞，必須由製造商、其服務代理或具

重要安全說明

有關資格的專業人員進行更換，以避免發生危險。

 **警告：**更換燈泡之前，請確保已關閉產品電源，以免觸電。

 **警告：**除了有能力的人員外，任何人進行任何需要拆除保護微波能量暴露的蓋子的服務或維修操作都是危險的。

 **警告：**不要在密封容器中加熱液體和其他食物，因為它們可能會爆炸。

 加熱塑料或紙質容器中的食物時，要注意微波爐，因為可能會引起火災。

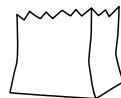

 只使用適用於微波爐的器具。

 如果冒煙，請關閉本電器或拔下插頭，並保持門關閉，以撲滅火焰。

 微波加熱飲料可能會延遲沸騰，因此在處理容器時必須小心。

 "餵食瓶和嬰兒食品罐的內容物在食用前應攪拌或搖晃並檢查溫度，以避免燙傷。

重要安全說明



"應定期清潔微波爐，清除任何食物殘留物。請保持波導區域清潔。" 當波導區域或腔體上有食物濺落殘留物時，使用濕軟布清潔。未清潔食物殘留物可能會導致微波腔體內出現無害的火花或煙霧，並可能導致腔體變色。"

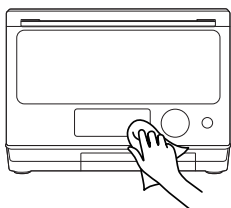

"未能保持烤箱清潔可能導致表面劣化，進而影響家電的使用。"



可能導致危險情況。



"僅使用此烤箱建議的溫度探針。"（對於提供使用溫度感應探針設施的烤箱。）



"微波爐必須在裝飾門打開的情況下運行。（對於帶有裝飾門的烤箱。）"





本設備用於家用和下列類似用途：

1. 店鋪內的員工廚房區域、辦公室及其他工作環境；
2. 酒店、氣車旅館和其他居住場所中的客戶；
3. 農舍；
4. 民宿類型環境。

重要安全說明

 微波爐用於加熱食物和飲料。烘乾食物或者衣服以及加熱電熱墊、拖鞋、海綿、濕布等可能會造成受傷、着火或者火災的風險。

 家電的後表面應靠在牆上。

 當家電運行時，可接觸表面的溫度可能很高。

 警告：當家電在組合模式下運行時，由於產生的高溫，兒童應在成人監督下使用烤箱。

 該設備旨在獨立使用。

 儲物抽屜表面可能會變熱。

 警告：家電及其可接觸部分在使用時會變熱。應注意避免觸碰加熱元件。8歲以下的兒童應遠離，除非有人持續監督。

 使用過程中，設備會變熱。應留意避免觸碰烤箱內的加熱元件。

 警告：可接觸部分在使用時可能變熱。應遠離幼兒。

 請勿使用蒸氣清潔器。

重要安全說明

- ❌ 不要使用粗糙的磨料清潔劑或鋒利的金屬刮刀清潔烤箱門玻璃，因為它們會刮傷表面，可能導致玻璃破裂。

- ❌ 不應在微波爐中加熱帶殼的蛋和整個煮熟的雞蛋，因為它們可能會爆炸，即使微波加熱已結束。

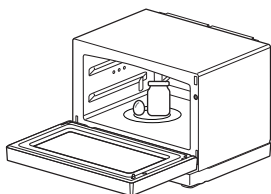

- ❌ 該設備不適用於外部計時器或獨立遙控系統操作。

- ❌ 未經櫥櫃測試的微波爐不得放置在櫥櫃中。

- ❌ 在微波爐烹飪期間不允許使用金屬容器來盛放食物和飲料。

- ❌ 不得使用蒸氣清潔器清潔家電。

- ❌ 該設備不得安裝在裝飾門後面，以避免過熱。

(裝飾門的家電不適用此項。)

仔細閱讀並保存以供日後參考，
僅限家庭使用
(不適用於商業用途)

減低對接地裝置人員造成傷害的風險

本電器必須接地。若發生電氣短路，接地可以為電流提供逃逸線，從而減少觸電風險。

本電器配有一根電線，該電線帶有接地線和接地插頭。插頭必須插入正確安裝和接地的插座。

警告 - 接地使用不當會導致觸電風險。如果您不完全理解接地說明或對電器接地的正確性存疑，請諮詢有執業資格的電工或維修人員。

如果需要使用延長線，僅使用三芯延長線。



危險

觸電危險：

觸摸某些內部部件會導致嚴重的人身傷害或死亡。
請勿拆卸本電器。

減低對接地裝置人員造成傷害的風險



觸電危險：

接地不當會導致觸電。在電器正確安裝和接地前，請勿插入插座。

1. 提供短電源線，以減少被長電源線纏住或絆倒的風險。
2. 如果使用長線或延長線：
 - (1) 線組或延長線的標記電氣額定值應至少與本電器的電氣額定值相等。
 - (2) 延長線必須是接地型三芯線。
 - (3) 長線的佈置應確保其不會懸垂在台面或桌面上，從而被兒童拉住或無意中絆倒他人。

清潔

請確保把本設備的插頭從電源上拔下。

1. 使用後，用微濕的布清潔微波爐腔體。
2. 按常規方法用肥皂水清洗配件。
3. 門框、密封條和相鄰部件髒污時，必須用濕布仔細清潔。
4. 切勿使用粗糙的擦洗劑或鋒利的金屬刮刀來清潔微波爐門玻璃，因為它們會劃傷表面，從而可能導致玻璃破碎。
5. 清潔小貼士 --- 為了更容易地清潔烹飪食物可以接觸到的爐腔壁：將半個檸檬放入碗中，加入 300 毫升（1/2 品脫）水，在 100% 微波功率下加熱 10 分鐘。再用柔軟的乾布將微波爐擦拭乾淨。

器皿



注意

人身傷害危險：

必須由合資格人員執行與拆卸微波能量蓋（此蓋可防止接觸微波能量）相關的任何服務或維修操作，否則會造成危險。參考“**可用於微波爐的材料**”或“**不可用於微波爐的材料**”。

部分非金屬器皿用微波爐加熱可能不安全。如有疑問，請按照以下程序測試不確定的器皿。

器皿測試：

1. 在適用於微波安全容器中加入 1 杯冷水（250ml），將該容器和待測試器皿一起放入微波爐。
2. 在最大功率下烹飪 1 分鐘。
3. 仔細觸摸器皿。如果器皿在空置時有熱度，請勿用於微波烹飪。
4. 烹飪時間不得超過 1 分鐘。

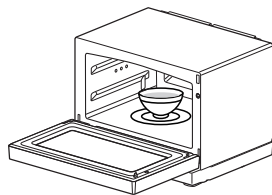

注意

保持微波爐爐腔和波導區域清潔

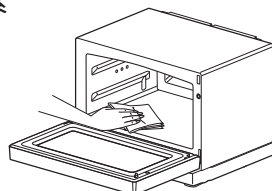

可用於微波爐的材料

餐具	備註	
 燒烤盤	遵循製造商的說明。 燒烤盤的底部必須在轉盤上方至少 3/16 英寸 (5mm)。 使用不當可能造成轉盤損壞。	
 器皿	微波專用。遵循製造商的說明。請勿使用有裂紋或者缺口的盤子。	
 玻璃罐	務必取下蓋子。僅用於加熱食物，直至食物剛好變熱。 大多數玻璃罐不耐熱，可能會破裂。	
 玻璃器皿	僅限耐熱微波爐玻璃器皿。確保沒有金屬裝飾。請勿使用有裂紋或者缺口的盤子。	
 微波爐烹飪袋	請遵循製造商使用說明。請勿用金屬紮帶封閉。 留出縫隙，以便蒸氣逸出。	
 紙盤和紙杯	僅用於短時間烹飪 / 加熱。烹飪時，微波爐必須有人看管。	
 紙巾	用於覆蓋食物以重新加熱和吸收脂肪。僅在監督下用於短時間烹飪。	
 烤盤紙	用作蓋子防止飛濺，或用作包裝防止蒸氣溢出。	

可用於微波爐的材料

餐具	備註
 <p data-bbox="164 411 216 437">塑料</p>	<p data-bbox="331 272 896 475">微波專用。遵循製造商的說明。應有貼上“微波安全”的標籤。當裏面的食物變熱時，一些塑料容器會軟化。應按照包裝上的說明，對“可煮袋”和密封塑料袋進行開口、穿孔或通風處理。</p> 
 <p data-bbox="153 624 227 649">保鮮紙</p>	<p data-bbox="331 539 882 624">微波專用。用於烹飪時覆蓋食物，以保持水分。請勿讓保鮮膜接觸食物。</p> 
 <p data-bbox="153 799 227 825">溫度計</p>	<p data-bbox="331 740 757 766">僅限微波爐專用（肉類和糖類溫度計）。</p> 
 <p data-bbox="164 970 216 995">蠟紙</p>	<p data-bbox="331 911 656 936">用作蓋子防止飛濺並保持水分。</p> 

不可用於微波爐的材料

餐具	備註	
 鋁盤	可能引起擊穿。應將食物轉移到微波爐安全盤中。	⊗
 帶金屬把手的食物紙箱	可能引起擊穿。應將食物轉移到微波爐安全盤中。	⊗
 金屬或金屬裝飾器皿	金屬阻隔微波能量。金屬裝飾能引起擊穿。	⊗
 金屬扎帶	能引起擊穿，並可導致微波爐着火。	⊗
 紙袋	可能引起微波爐起火。	⊗
 發泡膠	發泡膠在高溫下會融化或污染容器內的液體。	⊗
 木製器皿	木製品在微波爐中使用時會變乾，並可能破裂。	⊗

微波爐零件和配件的名稱

從紙箱和微波爐腔中取出所有材料。

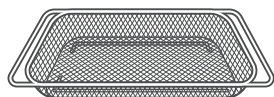
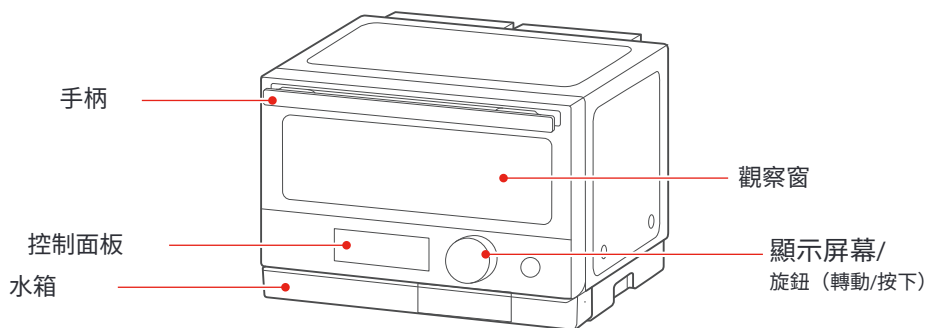

空氣炸籃
(不能用於微波烹飪，放置在腔體插槽中，用於空氣炸烹飪。)



烤盤
(不能用於微波烹飪，放置在腔體插槽中，用於烹飪會滴漏的食物。)

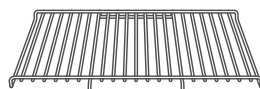

烤架
(不能用於微波烹飪，直接放在烤腔底部或烤盤上，用於烤、焗和蒸煮。)



如果本手冊中的圖片與產品有任何不同，以產品為準。

水箱使用

淨水箱

(在蒸氣和清潔功能之前，將600ml蒸餾水倒入箱中。)

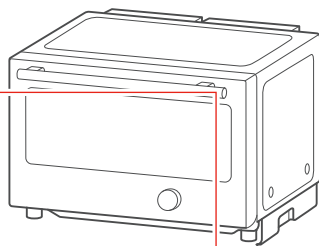

污水箱

(用於接收從腔體滴下的水。)
注意：請在烹飪後將剩餘的水排出。

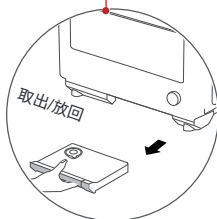
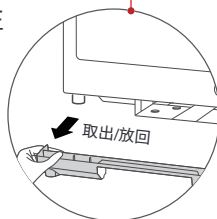

1. 加水方法

方法1

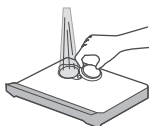

打開橡膠蓋，加入適量的溫室水/蒸餾水，蓋上橡膠蓋，確保密封良好。

方法二

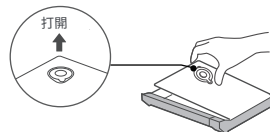

打開淨水箱蓋，加入適量的溫室水/蒸餾水，蓋上水箱蓋，確保密封良好。

2. 清潔水箱的方法

01

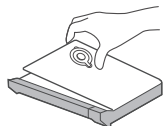

打開淨水箱蓋進行清洗，或排出剩餘的水。

02



用水沖洗淨水箱和污水箱的內部。

枱面安裝

移除所有包裝材料和配件。檢查微波爐是否有任何損壞，如凹痕或破損的門。如果微波爐損壞，請勿安裝。

櫥櫃：從微波爐櫥櫃表面上拆下任何保護膜。不要拆下附在爐腔上的波導罩，以保護磁控管。

安裝

1. 選擇一個平穩的表面，提供足夠的開放空間，以便進風口和/或出風口。
 - a. 最小安裝高度為85cm。
 - b. 設備的後表面應靠在牆上。在微波爐上方留出至少30cm的空隙。微波爐與相鄰牆壁之間需要至少20cm的空隙。
 - c. 不要從微波爐底部拆下腳。
 - d. 阻塞進風口和/或出風口可能會損壞微波爐。
 - e. 將微波爐放置在電視和收音機盡可能遠的地方。使用微波爐可能會對您的收音機或電視接收造成干擾。

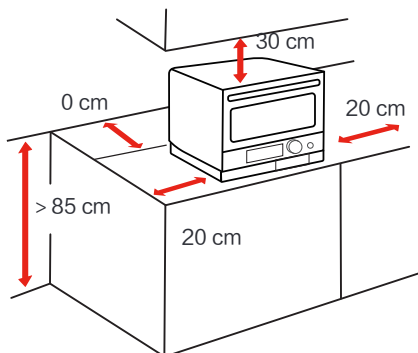

側面	距離 cm
頂部	30cm/開放空間
左側	20cm
右側	20cm
後面	0cm
前面	開放空間

2. 將微波爐插入標準家庭插座。請確保電壓和頻率與評級標籤上的電壓和頻率相同。



注意事項

- 不要在爐竈或其他產生熱量的設備上方安裝微波爐。
如果安裝在熱源附近或上方，微波爐可能會受損，並且保修將無效。

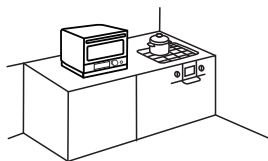

在操作期間，可接觸的表面
可能會變熱

使用說明

首次使用前

當微波爐首次使用時，可能會產生難聞的氣味，這是正常的。

本節將告訴您在首次使用微波爐準備食物之前需要做什麼。事先閱讀名為“產品安全”的部分。



注意事項

您必須清潔爐腔和配件。

操作

控制面板和功能

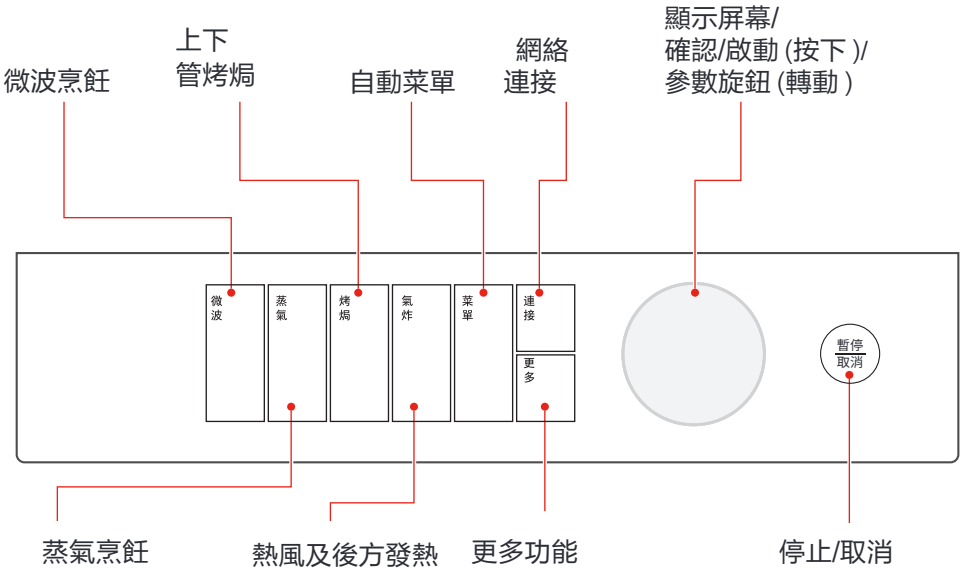

(您也可以通過應用程序控制烤箱)



應用程式控制：首先下載TSmartLife應用程式，然後按照應用程式連接指南將應用程式連接到您的產品。

1. 微波烹飪

有五個功率級別可供選擇。

功率	100%	80%	50%	30%	10%
顯示	1000W	800W	500W	300W	100W

- a 按下“微波”一次，然後顯示“1000W”。

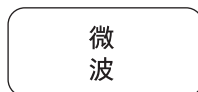

- b 轉動旋鈕設定功率級別。
有5個功率級別可用。

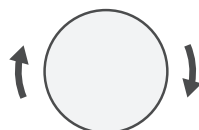

- c 按下旋鈕確認。



- d 轉動旋鈕設定烹飪時間。
最大時間值為“01時30分”。

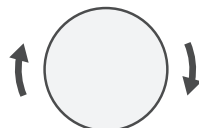

- e 按下旋鈕開始烹飪。



注意事項

• 可以在操作期間通過轉動旋鈕更改烹飪時間。

應用程式控制：



注意事項

• 為確保安全，不允許使用應用程式遙控功能。

- 1 點擊微波圖標進入烹飪功能設置頁面

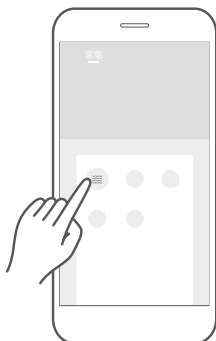

- 2 上下滑動設置功率等級。

輕觸此區域退出烹飪參數選項卡，返回設備功能頁面。

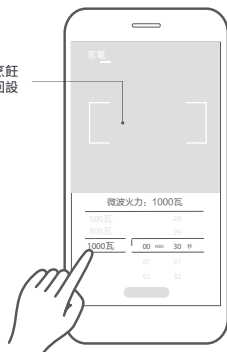

- 3 上下滑動設置烹飪時間。

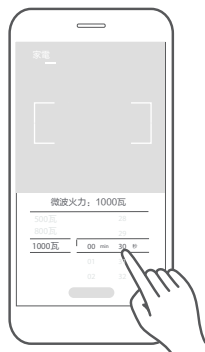

- 4 輕觸“啟動”進行確認。



- 5 請閱讀說明後，輕觸“確定”進行確認。

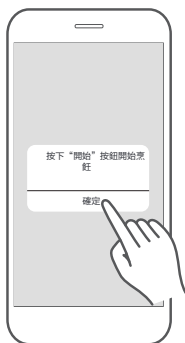

- 6 請閱讀提示，輕觸“現在開始”進行確認。然後按下家電上的旋鈕開始烹飪

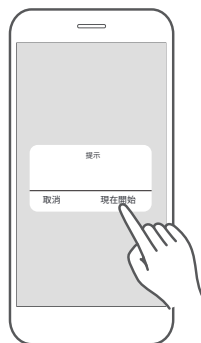

注意事項

• 選擇參數時，不要滑動得太快。
當數字停止滾動時，輕觸“開始”按鈕。

2. 蒸煮

- a 按下“蒸氣”一次，然後顯示“純蒸”。

蒸氣

- b 按下旋鈕確認。



- c 轉動旋鈕設定溫度，可選擇“50°C-100°C”。

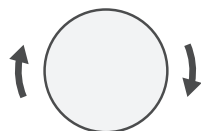

- d 按下旋鈕確認。



- e 轉動旋鈕設定烹飪時間。
最大時間值為“01時30分”。

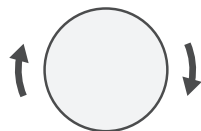

- f 按下旋鈕開始烹飪。



注意事項

- 在開始蒸氣烹飪模式之前，請清潔水箱並添加溫室水/蒸餾水。
- 可以在操作期間通過轉動旋鈕更改烹飪時間。
- 在蒸氣烹飪開始時，如果腔體溫度過高，“爐溫過高 開門散熱”將顯示。
- 在蒸氣烹飪模式下，當檢測到缺水時，烹飪過程將自動暫停，“水盒缺水 請加水”將顯示。

應用程式控制：



注意事項

- 為確保安全，不允許使用應用程式遙控功能。

- 1 點擊蒸氣圖標  進入
進入烹飪功能設置頁面。

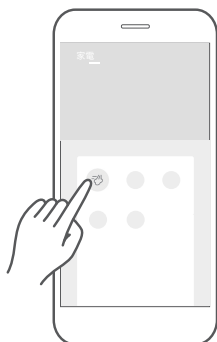

- 2 向上或向下滑動以設定溫度。

輕觸此區域退出烹飪
參數選項卡，返回設
備功能頁面。

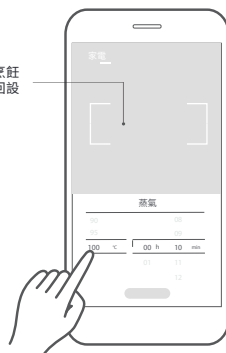

- 3 上下滑動設置烹飪時間。

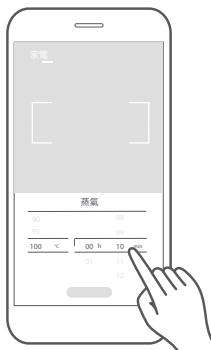

- 4 點擊“開始”確認，然後按下家電上的
旋鈕開始烹飪。

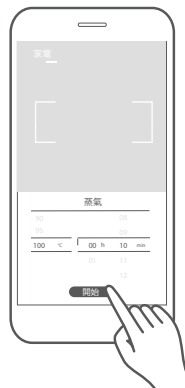

注意事項

- 選擇參數時，不要滑動得太快。
當數字停止滾動時，輕觸“開始”按鈕。

3. 高溫蒸烹飪

- a 按下“蒸氣”一次，然後顯示“純蒸”。

蒸氣

- b 轉動旋鈕選擇“高溫蒸”，然後按下旋鈕確認。

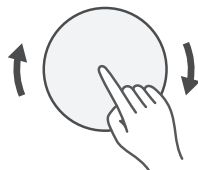

- c 轉動旋鈕以設定溫度，“110°C-130°C”可用。

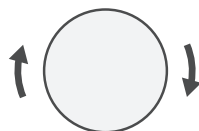

- d 按下旋鈕確認。



- e 轉動旋鈕設定烹飪時間。
最大時間值為“01時30分”。

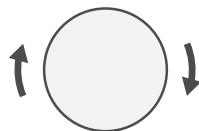

- f 按下旋鈕開始烹飪。



注意事項

- 在開始蒸氣烹飪模式之前，請清潔水箱並添加溫室水/蒸餾水。
- 可以在操作期間通過轉動旋鈕更改烹飪時間。
- 在蒸氣烹飪開始時，如果腔體溫度過高，“爐溫過高 開門散熱”將顯示。
- 在蒸氣烹飪模式下，當檢測到缺水時，烹飪過程將自動暫停，“水盒缺水請加水”將顯示。

應用程式控制：



注意事項

- 為確保安全，不允許使用應用程式遙控功能。

- 1 點擊高溫蒸圖標  進入烹飪功能設置頁面。

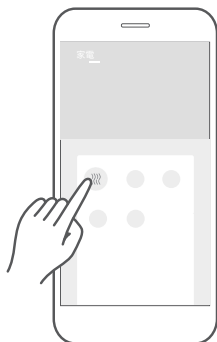

- 2 向上或向下滑動以設定溫度。

輕觸此區域退出烹飪參數選項卡，返回設備功能頁面。

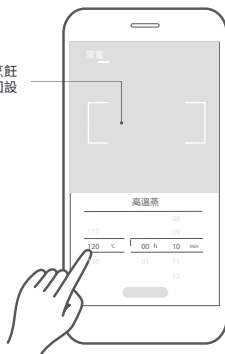

- 3 上下滑動設置烹飪時間。

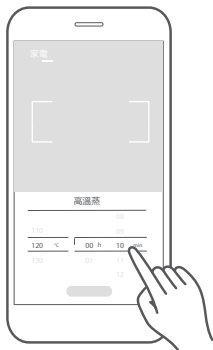

- 4 點擊“開始”確認，然後按下家電上的旋鈕開始烹飪。



注意事項

- 選擇參數時，不要滑動得太快。
當數字停止滾動時，輕觸“開始”按鈕。

4. 無需預熱的過熱水蒸氣烤焗

- a 按下“蒸氣”一次，然後顯示“純蒸”。

蒸氣

- b 轉動旋鈕選擇“過熱水蒸氣”，然後按下旋鈕確認。

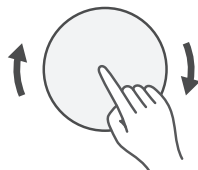

- c 轉動旋鈕以設定溫度，“100°C-230°C”可用。

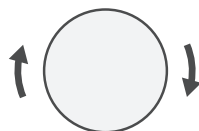

- d 按下旋鈕確認。



- e 轉動旋鈕設定烹飪時間。
最大時間值為“01時30分”。

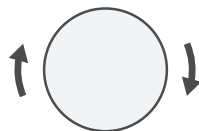

- f 按下旋鈕開始烹飪。



注意事項

- 在開始蒸氣烹飪模式之前，請清潔水箱並添加溫室水/蒸餾水。
- 可以在操作期間通過轉動旋鈕更改烹飪時間。
- 在蒸氣烹飪模式下，當檢測到缺水時，烹飪過程將自動暫停，“水盒缺水請加水”將顯示。

5. 帶預熱功能的過熱水蒸汽烤焗

a 按下“蒸氣”一次，然後顯示“純蒸”。

蒸氣

b 轉動旋鈕選擇“預熱+過熱水蒸氣”，然後按下旋鈕確認。

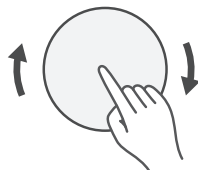

c 轉動旋鈕以設定溫度，“100°C-230°C”可用。

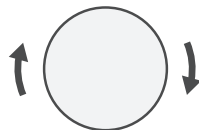

d 按下旋鈕確認。



e 轉動旋鈕設定烹飪時間。最大時間值為“01時30分”。

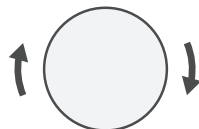

f 按下旋鈕開始預熱。



g 當預熱完成時，“預熱結束 請放入食物”將顯示。打開門，將食物放入烤箱。關上烤箱門，然後按下旋鈕開始烹飪。



注意事項

- 在開始蒸氣烹飪模式之前，請清潔水箱並添加溫室水/蒸餾水。
- 烹飪時間可以在操作期間（預熱除外）通過旋轉旋鈕進行更改。
- 在蒸氣烹飪模式下，當檢測到缺水時，烹飪過程將自動暫停，“水盒缺水請加水”將顯示。

應用程式控制：



注意事項

• 為確保安全，不允許使用應用程式遙控功能。

1 點擊過熱水蒸氣烤焗烹飪圖標



進入烹飪功能設置頁面。

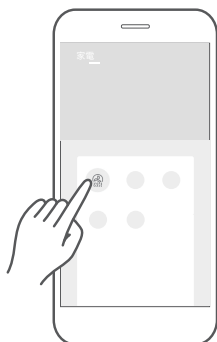

2 向上或向下滑動以設定溫度。

輕觸此區域退出烹飪
參數選項卡，返回設
備功能頁面。

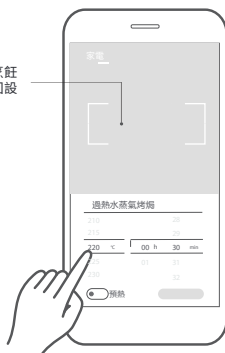

3 上下滑動設置烹飪時間。

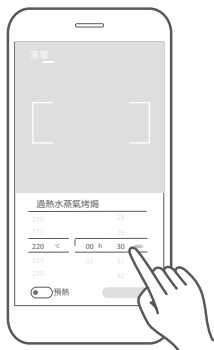

4 點擊  圖標選擇
預熱開/關。

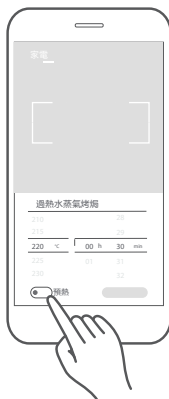

5 點擊“開始”以確認，然
後按下家電上的旋鈕
開始烹飪。

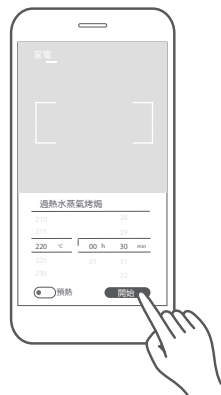

注意事項

• 選擇參數時，不要滑動得太快。
當數字停止滾動時，輕觸“開始”按鈕。

6. 具有預熱的烤焗功能

*以上及下方發熱管烹調食物

- a 按下“烤焗”一次，然後顯示“預熱”。
- b 按下旋鈕確認。然後轉動旋鈕設置溫度，可選擇“100° C–230° C”。
- c 按下旋鈕開始預熱。
- d 預熱完成後，顯示“預熱結束”。
打開門，將食物放入烤箱。
關上烤箱門，“烤焗”將顯示。然後按下旋鈕確認。
- e 轉動旋鈕設置溫度，可選擇“100° C–230° C”。
然後按下旋鈕確認。
- f 轉動旋鈕設定烹飪時間。最大時間值為“01時30分”。
- g 按下旋鈕開始烹飪。

烤焗

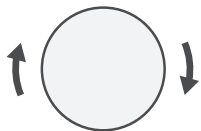
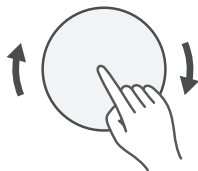
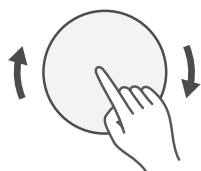

注意事項

- 預熱完成後，如果按下“”或在30分鐘內沒有操作，烤箱將進入“烤焗”設置模式。
- 烹飪時間可以在操作期間（預熱除外）通過旋轉旋鈕進行更改。

7. 無需預熱的烤焗功能

*以上及下方發熱管烹調食物

- a 按下“烤焗”一次，然後顯示“預熱”。

烤
焗

- b 轉動旋鈕選擇“烤焗”，然後按下旋鈕確認。

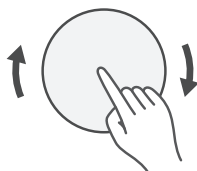

- c 轉動旋鈕以設定溫度，“100° C-230° C”可用。

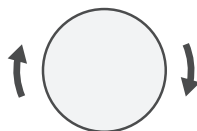

- d 按下旋鈕確認。



- e 轉動旋鈕設定烹飪時間。最大時間值為“01時30分”。

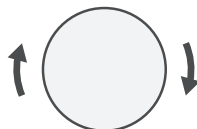

- f 按下旋鈕開始烹飪。



注意事項

• 可以在操作期間通過轉動旋鈕更改烹飪時間。

應用程式控制：



注意事項

• 為確保安全，不允許使用應用程式遙控功能。

- 1 點擊烤焗圖標  進入烹飪功能設置頁面。

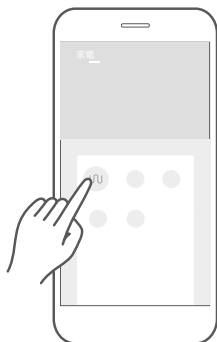

- 2 向上或向下滑動以設定溫度。

輕觸此區域退出烹飪參數選項卡，返回設備功能頁面。

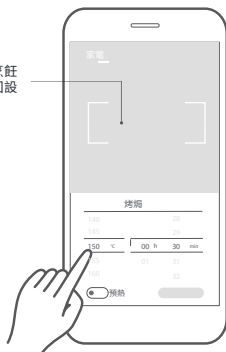

- 3 上下滑動設置烹飪時間。

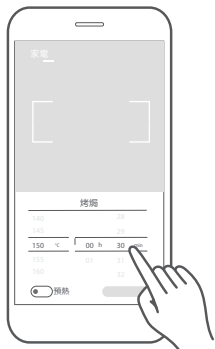

- 4 點擊  圖標選擇預熱開/關。

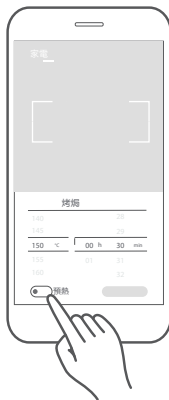

- 5 點擊“開始”以確認，然後按下家電上的旋鈕開始烹飪。

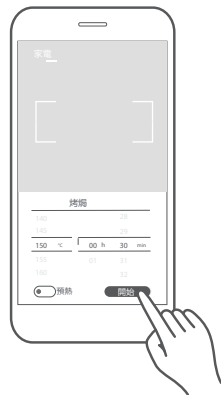

注意事項

• 選擇參數時，不要滑動得太快。
當數字停止滾動時，輕觸“開始”按鈕。

8. 預熱功能的空氣炸

*以熱風及後方發熱管烹調

a 按下“氣炸” 按下“預熱”一次，然後顯示。

b 按下旋鈕確認。然後轉動旋鈕設置溫度，可選擇“100°C-230°C”。

c 按下旋鈕開始預熱。

d 預熱完成後，顯示“預熱結束”。
打開門，將食物放入烤箱。
關閉烤箱門，“氣炸”將顯示。
然後按下旋鈕確認。

e 轉動旋鈕設置溫度，可選擇“100°C-230°C”。
然後按下旋鈕確認。

f 轉動旋鈕設定烹飪時間。
最大時間值為“01時30分”。

g 按下旋鈕開始烹飪。

氣炸

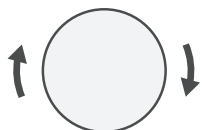
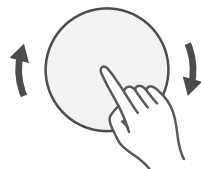
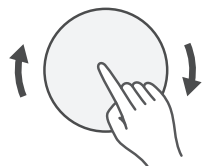

注意事項

- 預熱完成後，如果點擊“暫停取消”鍵或者在30分鐘內沒有操作，烤箱將進入“氣炸”設置。
- 烹飪時間可以在操作期間（預熱除外）通過旋轉旋鈕進行更改。

9. 不帶預熱功能的空氣炸

*以熱風及後方發熱管烹調

a 按下“**氣炸**” 按下“預熱”一次，然後顯示。

氣
炸

b 轉動旋鈕選擇“氣炸”，然後按下旋鈕確認。

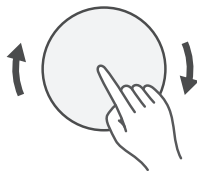

c 轉動旋鈕以設定溫度，“100°C-230°C”可用。

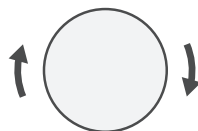

d 按下旋鈕確認。



e 轉動旋鈕設定烹飪時間。
最大時間值為“01時30分”。

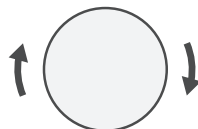

f 按下旋鈕開始烹飪。



注意事項

• 可以在操作期間通過轉動旋鈕更改烹飪時間。

應用程式控制：



注意事項

• 為確保安全，不允許使用應用程式遙控功能。

- 1 點擊氣炸圖標  進入烹飪功能設置頁面。

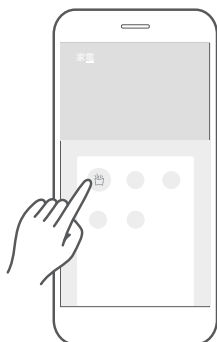

- 2 向上或向下滑動以設定溫度。

輕觸此區域退出烹飪參數選項卡，返回設備功能頁面。

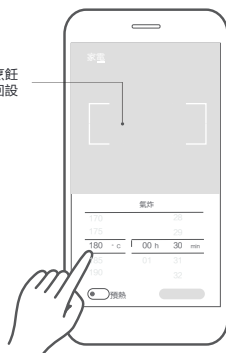

- 3 上下滑動設置烹飪時間。

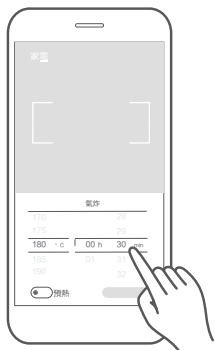

- 4 點擊  圖標選擇預熱開/關。

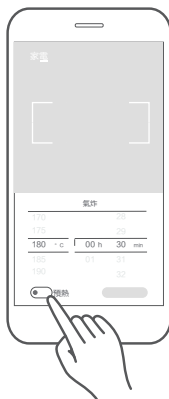

- 5 點擊“開始”以確認，然後按下家電上的旋鈕開始烹飪。

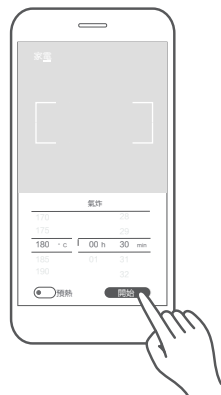

注意事項

• 選擇參數時，不要滑動得太快。
當數字停止滾動時，輕觸“開始”按鈕。

10. 自動菜單

- a 按下“菜單”一次，然後“炸蝦天婦羅”將顯示。

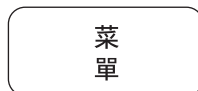

- b 轉動旋鈕選擇所需菜單。
提供47種自動菜單。

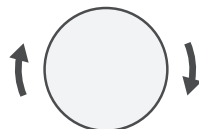

- c 按下旋鈕確認。



- d 轉動旋鈕調整烹飪時間。

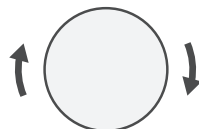

- e 按下旋鈕開始烹飪。



注意事項

•對於“3, 10, 31, 32, 33, 34, 35, 40”菜單，蜂鳴器將發出提示聲，提醒您在烹飪過程中翻轉或攪拌食物，或添加一些配料。
您必須按下旋鈕繼續烹飪。

菜單表

菜單	重量/份量 (建議)	預設時間	功率
1 炸蝦天婦羅	400克	07分	氣炸 200° C
2 日式吉列豬扒	500克	25分	氣炸 220° C
3 香烤秋刀魚	300克	15分	烤焗 200° C (預熱)
4 脆烤多春魚	250克	20分	氣炸 230° C
5 日式茶碗蒸	600克	20分	蒸氣 100° C
6 玉子豆腐蒸蝦仁	500克	10分	蒸氣 100° C
7 漢堡扒	600克	20分	烤焗 220° C (預熱)
▶ 8 土豆燉肉	1000克	01時10分	微波 1000W+500W
9 蜜糖雞中翼	500克	24分	烤焗 200° C (預熱)
10 黑椒牛扒	500克	07分	烤焗 230° C (預熱)
11 椒鹽烤蝦	400克	09分	氣炸 200° C
12 韓式烤魷魚	750克	07分	烤焗 230° C (預熱)
▶ 13 蘿蔔炆牛腩	1000克	01時10分	微波 1000W+500W
14 剉椒魚頭	600克	20分	蒸氣 100° C
▶ 15 辣味豬手	1000克	01時10分	微波 1000W+500W
16 川式焗銀鱈魚	250克	10分	烤焗 230° C (預熱)
▶ 17 東北醬骨架	1000克	01時10分	微波 1000W+500W
18 檸檬酸辣鳳爪	500克	30分	蒸氣 100° C
19 蒸娃娃菜	400克	13分	蒸氣 100° C
20 清蒸檸檬鱸魚	500克	15分	蒸氣 100° C
21 清蒸大閘蟹	600克	18分	蒸氣 100° C
22 蒸燒賣	200克	15分	蒸氣 100° C
23 紅棗杞子滑雞	500克	20分	蒸氣 100° C
24 焗蔬菜串	350克	20分	烤焗 180° C
▶ 25 小青花撈貝絲	200克	05分	微波 1000W
26 孔雀開屏魚	700克	18分	蒸氣 100° C

菜單表

菜單	重量/份量 (建議)	預設時間	功率
27 香烤紅薯	1000克	50分	氣炸 230° C
28 急凍炸薯條	500克	20分	氣炸 200° C
29 急凍炸雞塊	500克	23分	氣炸 220° C
30 小酥肉	350克	20分	氣炸 220° C
31 炸雞柳	350克	20分	氣炸 190° C
32 蜜糖雞脾	900克	40分	氣炸 200°
33 烤腸	300克	13分	氣炸 160° C
34 蜂蜜栗子	500克	15分	氣炸 200° C
35 炸花生米	300克	23分	氣炸 160° C
36 奶香燕麥脆蝦球	550克	12分	氣炸 180° C
37 葡撻	9片	23分	氣炸 180° C (預熱) + 烤焗 220° C 空氣炸
38 戚風蛋糕	8英寸	50分	150° C + 130° C +140° C (預熱)
39 蔓越莓曲奇	12片	23分	氣炸 140° C +160° C (預熱)
40 吐司	500克	40分	烤焗 160° C (預熱)
41 紙杯蛋糕	350克	17分	烤焗 170° C (預熱)
42 牛角卷	350克	15分	烤焗 160° C (預熱)
43 焦糖布甸	800克	20分	烤焗 140° C (預熱)
44 海鮮Pizza	750克	18分	烤焗 180° C (預熱)
45 意式薄批	600克	16分	烤焗 180° C +200° C (預熱)
46 艾草茶糰	600克	15分	蒸氣 100° C
▶47 楊枝甘露	500克	13分	微波 1000W

應用程式控制：



注意事項

- 為確保安全，不允許使用應用程式遙控功能。

- 1 點擊菜單圖標進入自動菜單功能設置頁面。
然後您可以點擊“查看食譜”打開相關的食譜。

輕觸此區域退出烹飪參數選項卡，返回設備功能頁面。



- 2 上下滑動設置烹飪時間。



- 3 點擊“開始”確認，然後按下家電上的旋鈕開始烹飪。



注意事項

- 選擇參數時，不要滑動得太快。
當數字停止滾動時，輕觸“開始”按鈕。

11. 無線連接

連接網絡：

- a** 按下“**連接**”一次，然後顯示“未連接網絡”。

連接

- b** 按旋鈕一次，顯示“請打開App TSmartLife”。

然後打開 TSmartLife 應用程式連接網絡。

如果網絡連接成功，“網絡已連接”將顯示。否則，“未連接網絡”將顯示。



斷開網絡連接：

- a** 按下“**連接**”一次，然後“網絡已連接”將顯示。

連接

- b** 旋鈕按一次，“確認重置連接？”將顯示。



- c** 再次按旋鈕確認。

如果連接已成功刪除，屏幕將顯示“重置成功”。如果失敗，“重置失敗”將顯示。



12. 解凍

- a 按下“更多”一次，然後“解凍”將顯示。

更多

- b 按下旋鈕確認。



- c 旋鈕設置食物的重量。
重量範圍為100至1500克。

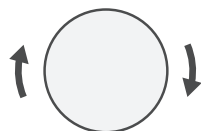

- d 按下旋鈕開始解凍。



注意事項

- 解凍期間，蜂鳴器會發出提示，提醒您翻轉食物。
如果沒有操作，烤箱將繼續工作。

應用程式控制：



注意事項

• 為確保安全，不允許使用應用程式遙控功能。

- 1 點擊解凍圖標
進入烹飪功能設置頁面。

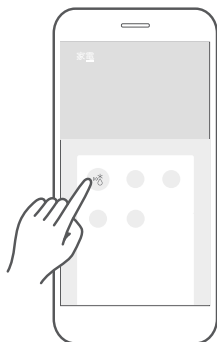

- 2 上下滑動設置食物重量。

輕觸此區域退出烹飪
參數選項卡，返回設
備功能頁面。

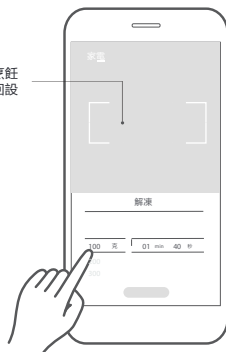

- 3 點擊“開始”確認。

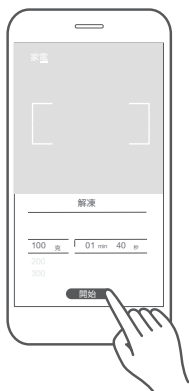

- 4 請閱讀說明後，輕觸“確定”進行確認。



- 5 請閱讀提示，輕觸“立即啟動”進行確認。
然後按下家電上的旋鈕開始烹飪

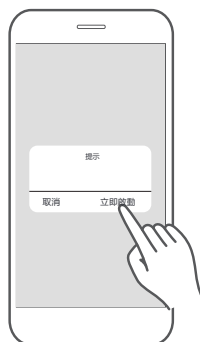

注意事項

• 選擇參數時，不要滑動得太快。
當數字停止滾動時，輕觸“開始”按鈕。

13. 發酵

- a 按下“更多”一次，然後“解凍”將顯示。

更多

- b 轉動旋鈕選擇“發酵”，然後按下旋鈕確認。

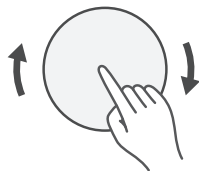

- c 轉動旋鈕設置溫度，可選“25°C-45°C”
然後按下旋鈕確認。

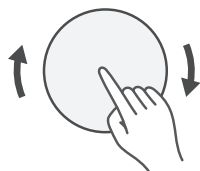

- d 轉動旋鈕設定烹飪時間。
最大時間值為“12時”。

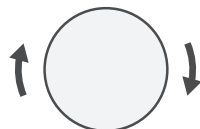

- e 按下旋鈕開始發酵。



注意事項

- 可以在操作期間通過轉動旋鈕更改烹飪時間。
- 在發酵開始時，如果腔體溫度超過50°C，“爐溫過高 開門散熱”將顯示。

應用程式控制：



注意事項

- 為確保安全，不允許使用應用程式遙控功能。

- 1 點擊發酵  圖標進入烹飪功能設置頁面。

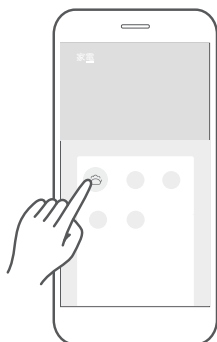

- 2 向上或向下滑動以設定溫度。



- 3 上下滑動設置烹飪時間。

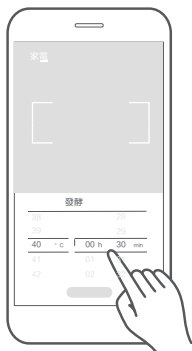

- 4 點擊“開始”確認，然後按下家電上的旋鈕開始烹飪。

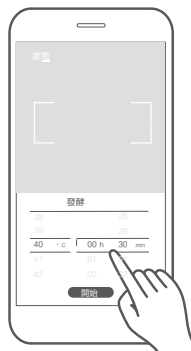

注意事項

- 選擇參數時，不要滑動得太快。
當數字停止滾動時，輕觸“開始”按鈕。

14. 保溫

- a 按下“**更多**”一次，然後“解凍”將顯示。

更多

- b 轉動旋鈕選擇“保溫”，然後按下旋鈕確認。

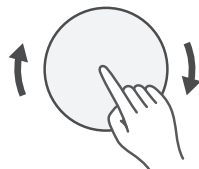

- c 轉動旋鈕設定烹飪時間。
最大時間值為“02時”。

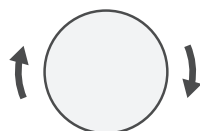

- d 按下旋鈕開始保溫。



注意事項

- 可以在操作期間通過轉動旋鈕更改烹飪時間。
- 保溫功能在傳統模式下以60°C的溫度維持食物的溫度。

15. 除菌

- a 按下“更多”一次，然後“解凍”將顯示。

更多

- b 轉動旋鈕選擇“除菌”，然後按下旋鈕確認。

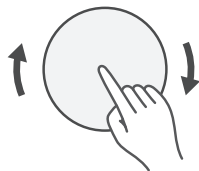

- c 轉動旋鈕設定烹飪時間。最大時間值為“01時30分”。

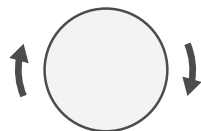

- d 按下旋鈕開始工作。



注意事項

- 可以在操作期間通過轉動旋鈕更改烹飪時間。
- 殺菌功能在蒸氣模式下以100° C的溫度運作。

16. 烘乾

- a 按下“更多”一次，然後“解凍”將顯示。

更多

- b 轉動旋鈕選擇“烘乾”，然後按下旋鈕確認。

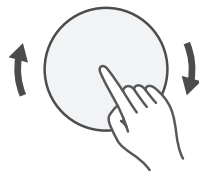

- c 轉動旋鈕設定烹飪時間。最大時間值為“01時30分”。

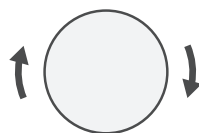

- d 按下旋鈕開始工作。



注意事項

- 可以在操作期間通過轉動旋鈕更改烹飪時間。
- 烤箱乾燥功能在空氣炸模式下以120° C的溫度運作。

17. 除味

- a 按下“更多”一次，然後“解凍”將顯示。

更多

- b 轉動旋鈕選擇“除味”，然後按下旋鈕確認。

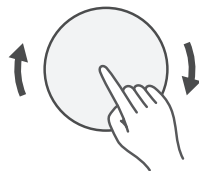

- c 轉動旋鈕設定烹飪時間。
最大時間值為“10分”。

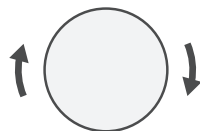

- d 按下旋鈕開始工作。



注意事項

- 可以在操作期間通過轉動旋鈕更改烹飪時間。

18. 清潔

- a 按下“更多”一次，然後“解凍”將顯示。

更多

- b 轉動旋鈕選擇“清潔”，然後按下旋鈕確認。

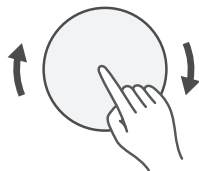

- c 轉動旋鈕設定烹飪時間。
最大時間值為“30分”。

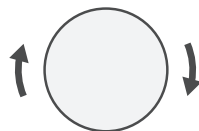

- d 按下旋鈕開始工作。



注意事項

- 可以在操作期間通過轉動旋鈕更改烹飪時間。
- 清潔功能在100°C蒸氣下運作。
- 操作前，用清水擦拭內腔殘留物，並保持水箱充滿水。
- 清潔結束後需要用抹布清除污漬。

19. 除垢

- a 取出水箱，加入約10克食品級檸檬酸，加滿溫室水/蒸餾水溶解，然後放回水箱。

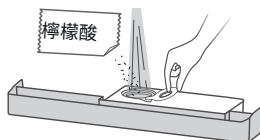

- b 在烤箱腔的左側，蒸氣出口上放一條乾毛巾。然後關上烤箱門。

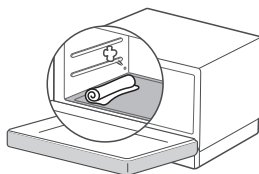

- c 按“更多”一次，然後“解凍”將顯示。

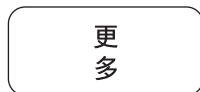

- d 轉動旋鈕選擇“除垢”，然後按下旋鈕開始工作。

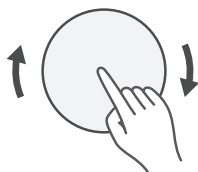

- e 當顯示“請抹乾爐腔重新換水”並暫停程序時，清空水箱，擦乾烤箱內腔，並清潔毛巾。

重新加滿水箱，再次將毛巾放在蒸氣出口下。



- f 按下旋鈕繼續工作。



注意事項

建議：

- 最好每月清潔一次蒸發管。
- 清潔結束後需要用抹布擦乾烤箱腔。

應用程式控制：



注意事項

- 為確保安全，不允許使用應用程式遙控功能。

對於“保溫、殺菌、烤箱乾燥、除臭、清潔”功能：

- 1 點擊保溫圖標進入功能設置頁面。
- 2 向上或向下滑動以設置時間。
- 3 點擊“開始”確認，然後按下家電旋鈕開始烹飪。

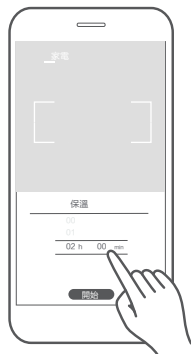
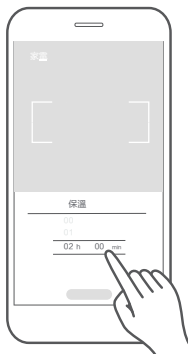
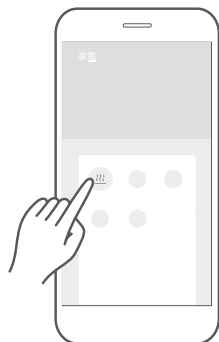

對於“除垢”功能：

- 1 點擊除垢圖標進入功能設置頁面。
- 2 點擊“開始”確認，然後按下家電旋鈕開始烹飪。

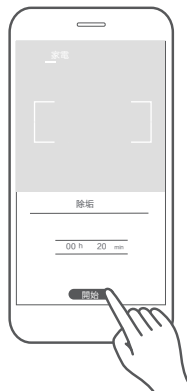
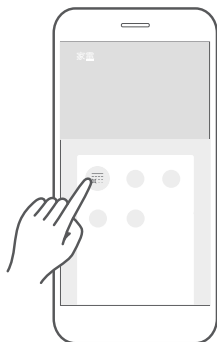

注意事項

- 選擇參數時，不要滑動得太快。
當數字停止滾動時，輕觸“開始”按鈕。

20. 節能功能

- a** 要進入節能模式：
在待機模式下，按“



”一次，或者在五分鐘內沒有操作，屏幕將關閉。



- b** 要取消節能模式：
在節能模式下，按任意鍵、旋轉旋鈕或打開門都會取消節能模式。



注意事項

- 當屏幕關閉後五分鐘內沒有操作時，烤箱將進入“0W”模式。在“0W”模式下，您必須打開烤箱門才能取消它，然後烤箱將進入待機模式。

應用程式控制：



注意事項

- 為確保安全，不允許使用應用程式遠距啟動產品。

食譜

食譜頁面顯示雲端食譜，烹飪參數已由專業廚師驗證。食譜頁面持續更新，提供更多烹飪選擇。

- 1 點擊美食交流圈圖片進入食譜詳細頁面。
- 2 向上或向下滑動以查看所需食材和詳細烹飪步驟。
點擊“一鍵烹飪”確認，然後按家電旋鈕開始烹飪。

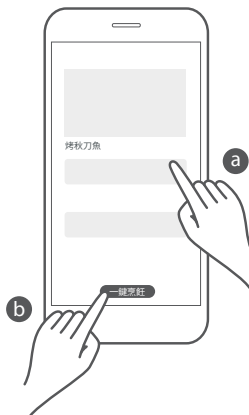
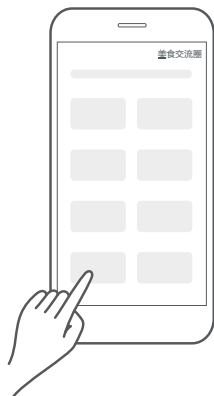

常見問題

1 問：家用電器支持5G無線路由器嗎？

答：本產品不支持5G頻段的無線路由器。在將家用電器接入網絡之前，請確保手機已連接到2.4G無線網絡。

2 問：為什麼需要打開手機的藍牙才能接入網絡？

答：打開手機的藍牙可以提高接入網絡的成功率，避免家用電器接入網絡失敗。

3 問：同一家用電器最多允許多少家庭成員使用應用程式？

答：

1) 一個家用電器只允許關聯一個帳戶。如果使用新帳戶綁定此家用電器，先前的帳戶將被強制解除連接並且無法使用。

2) 您可以在應用程式中使用共用功能，將使用家用電器的權限授予需要使用它的用戶，進入設備管理，選擇要共用的設備，點擊應用程式底部的按鈕添加共享用戶。

3) 分享用戶數量沒有限制。被分享的用戶擁有家電的所有操作權限。請謹慎使用此功能。

4) 主用戶刪除家電後，被分享用戶的家電將自動從APP中刪除。如果非主用戶分享刪除家電則僅從其帳戶中刪除，不影響其他用戶。

4 問：為什麼產品在APP中無法通過型號搜索？

答：

1) 檢查APP設置頁面上的區域是否與購買區域相同。如果地址信息不正確，則無法顯示型號。

2) 如果APP設置頁面的區域正確，請聯繫售後服務或通過APP上的幫助門戶尋求協助。

清潔和維護

清潔

通過良好的保養和清潔，您的家電將保持外觀和完全功能長時間使用。我們將在此解釋如何正確保養和清潔您的家電。



警告

- 在家電門上刮花的玻璃可能會變成裂縫。
不要使用玻璃刮刀、銳利或有磨損的清潔劑或清潔劑。
- 如果不正確清潔，家電表面可能會受損。微波能量可能會釋出。
定期清潔家電，立即清除任何食物殘留物。
- 不要浸泡家電或在水流下清潔。

清潔劑

為確保不同表面不被錯誤清潔劑損壞，請遵從以下的信息。使用前徹底清洗新海綿布。

不要使用：



磨砂或有磨蝕性的清潔劑



金屬或玻璃刮刀清潔門板



金屬或玻璃刮刀清潔門封



硬質擦洗墊或海綿



高酒精含量的清潔劑

家電前面

熱肥皂水：

使用抹布清潔，然後用柔軟的布擦乾。

不要使用金屬或玻璃刮刀清潔。

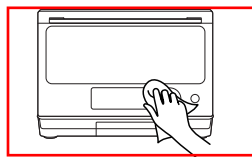

不銹鋼電器正面

熱肥皂水：

使用抹布清潔，然後用柔軟的布擦乾。

立即清除水垢、油脂、澱粉和蛋白質的飛濺和斑點。這些斑點或飛濺下可能會形成腐蝕。請勿使用玻璃清潔劑或金屬或玻璃刮刀進行清潔。

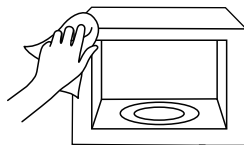

不銹鋼烹飪腔

熱肥皂水或醋溶液：

使用碗布清潔，然後用柔軟布擦乾。請勿使用烤箱噴霧或其他侵蝕性烤箱清潔劑或磨料材料。擦洗墊、粗糙的海綿和鍋具清潔劑也不適用。這些物品會刮傷表面。

讓內部表面完全乾燥。

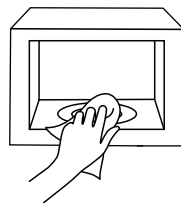

門板

玻璃清潔劑：

使用抹布清潔。請勿使用玻璃刮刀。

故障排除

正常

微波爐幹擾
電視接收

當微波爐運行時，可能會干擾收音機和電視的接收。這與小型電器（如攪拌器、吸塵器和電風扇）的干擾類似，這是正常現象。

微波爐燈光暗淡

在低功率微波烹飪中，微波爐燈光可能變暗。這是正常現象。

蒸氣積聚在門上，
熱氣從通風口排出

在烹飪過程中，食物可能會冒出蒸氣。大多數從通風口排出。但是一些蒸氣可能會積聚在像烤箱門這樣的冷卻位置。這是正常現象。

無食物情況下
啟動烤箱

禁止在烤箱內沒有任何食物的情況下運行烤箱。這非常危險。

故障	可能原因	解決方法
產品無法 啟動。	(1)電源線未插緊。	拔掉插頭。然後在10秒後重新插入插頭。
	(2)保險絲熔斷或斷路器跳開。	更換保險絲或重置斷路器（請聯繫製造商、其服務代理或具有關資格的專業人員進行更換。）
微波爐不發熱。	(3)插座故障。	使用其他電器測試插座。
	(4)門沒有關好。	門要關好。

#DetailsMatter

INSTRUCTION MANUAL

Steam oven with microwave function

Steam ,Roast ,Air fry ,Microwave : 4 in 1 cooking

MX2-STR25SC(WH)

Please review this instruction manual before operating.

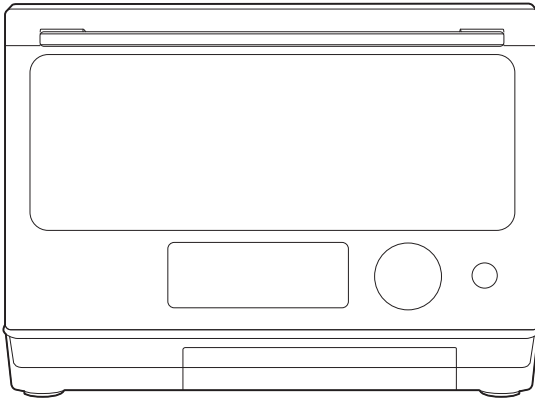

TOSHIBA

CONTENTS

PRODUCT SAFETY

Precautions to avoid possible exposure to excessive microwave energy	EN-01
Specifications	EN-02
Important safety instructions	EN-03
To reduce the risk of injury to persons grounding installation	EN-08
Cleaning	EN-10
Utensils.....	EN-11
Materials you can use in microwave oven	EN-12
Materials can not be used in microwave oven	EN-14

PRODUCT SETTING

Names of microwave oven parts and accessories	EN-15
Water box use	EN-16
Countertop installation	EN-17
Installation	EN-17

INSTRUCTION FOR USE

Before using for the first time	EN-18
Operation	EN-19
Control panel and features	EN-19
1. Microwave cooking	EN-20
2. Steam cooking	EN-22
3. High temp. Steam cooking	EN-24
4. Superheated steam cooking without preheat function	EN-26
5. Superheated steam cooking with preheat function	EN-27
6. Roasting cooking with preheat function	EN-29
7. Roasting cooking without preheat function	EN-30
8. Air fry with preheat function	EN-32

9 . Air fry without preheat function	EN-33
10. Auto menu	EN-35
11. Wireless connection	EN-39
12. Defrost	EN-40
13. Fermentation	EN-42
14. Keep warm	EN-44
15. Sterilization	EN-45
16. Oven dry	EN-46
17. Deodorization	EN-47
18. Cleaning	EN-48
19. Descaling.....	EN-49
20. Eco function	EN-51
Recipes	EN-51
FAQ	EN-52

CLEANING AND MAINTENANCE

Cleaning	EN-53
Trouble shooting	EN-55



NOTE

BEFORE OPERATING THIS PRODUCT, READ, UNDERSTAND, AND FOLLOW THESE INSTRUCTIONS. BE SURE TO SAVE THIS BOOKLIST FOR FUTURE REFERENCE.

PRECAUTIONS TO AVOID POSSIBLE EXPOSURE TO EXCESSIVE MICROWAVE ENERGY

- (a). Do not attempt to operate this oven with the door open since this can result in harmful exposure to microwave energy. It is important not to break or tamper with the safety interlocks.
- (b). Do not place any object between the oven front face and the door or allow soil or cleaner residue to accumulate on sealing surfaces.
- (c). **WARNING:** If the door or door seals are damaged, the oven must not be operated until it has been repaired by a competent person.

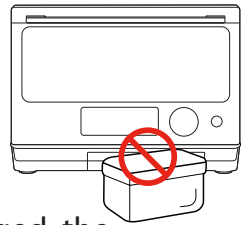

ADDENDUM

If the apparatus is not maintained in a good state of cleanliness, its surface could be degraded and affect the lifespan of the apparatus and lead to a dangerous situation.

SPECIFICATIONS

MODEL	MX2-STR25SC(WH)
RATED VOLTAGE/FREQUENCY	220 V~ 50 Hz
RATED INPUT(MICROWAVE)	1550 W
RATED OUTPUT(MICROWAVE)	1000 W
RATED INPUT(GRILL)	1600 W
RATED INPUT(CONVECTION)	2000 W
RATED INPUT(STEAM)	1500 W



NOTE

All pictures in this manual are for illustrative purposes only; these may be slightly different from the purchased equipment, please refer to the actual product.

IMPORTANT SAFETY INSTRUCTIONS



WARNING

To reduce the risk of fire, electric shock, injury to persons or exposure to excessive microwave oven energy when using your appliance, follow basic precautions, including the following:



Read and follow the specific: "**PRECAUTIONS TO AVOID POSSIBLE EXPOSURE TO EXCESSIVE MICROWAVE ENERGY**".



This appliance is not intended for use by persons (including children) with reduced physical, sensory or mental capabilities, or lack of experience and knowledge, unless they have been given supervision or instruction concerning use of the appliance by a person responsible for their safety.



Children should be supervised to ensure that they do not play with the appliance.

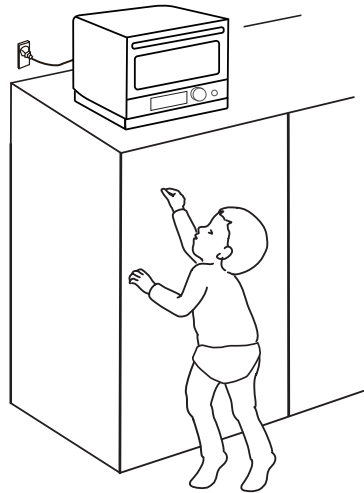



If the supply cord is damaged, it must be replaced by the

IMPORTANT SAFETY INSTRUCTIONS

manufacturer, its service agent or similarly qualified persons in order to avoid a hazard.

 **WARNING:** Ensure that the appliance is switched off before replacing the lamp to avoid the possibility of electric shock.

 **WARNING:** It is hazardous for anyone other than a competent person to carry out any service or repair operation that involves the removal of a cover which gives protection against exposure to microwave energy.

 **WARNING:** Liquids and other foods must not be heated in sealed containers since they are liable to explode.

 When heating food in plastic or paper containers, keep an eye on the oven due to the possibility of ignition.

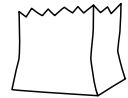

 Only use utensils that are suitable for use in microwave ovens.

 If smoke is emitted, switch off or unplug the appliance and keep the door closed in order to stifle any flames.

 Microwave heating of beverages can result in delayed eruptive boiling, therefore care must be taken when handling the container.

 The contents of feeding bottles and baby food jars shall be stirred or shaken and the temperature

IMPORTANT SAFETY INSTRUCTIONS

checked before consumption, in order to avoid burns.

 The oven should be cleaned regularly and any food deposits removed. Please keep the waveguide area clean. Use soft damp cloth to clean it up when there is food splash residue on the waveguide area or the cavity. Failure to clean food residue may cause innocuous sparking or some smoke in the microwave cavity, discoloration of the cavity may also occur.

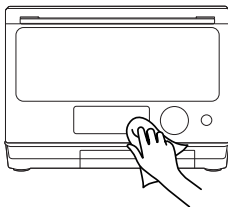

 Failure to maintain the oven in a clean condition could lead to deterioration of the surface that could adversely affect the life of the appliance and possibly

result in a hazardous situation.

 Only use the temperature probe recommended for this oven. (For ovens provided with a facility to use a temperature-sensing probe.)

 The microwave oven must be operated with the decorative door open. (For ovens with a decorative door.)

 This appliance is intended to be used in household and similar applications such as:

1. staff kitchen areas in shops, offices and other working environments;
2. by clients in hotels, motels and other residential type environments;
3. farm houses;
4. bed and breakfast type environments.

IMPORTANT SAFETY INSTRUCTIONS

 The microwave oven is intended for heating food and beverages. Drying of food or clothing and heating of warming pads, slippers, sponges, damp cloth and similar may lead to risk of injury, ignition or fire.

 The rear surface of appliances shall be placed against a wall.

 The temperature of accessible surfaces may be high when the appliance is operating.

 **WARNING:** When the appliance is operated in the combination mode, children should only use the oven under adult supervision due to the temperatures generated.

 The appliance is intended to be used freestanding.

 Surface of a storage drawer can get hot.

 **WARNING:** The appliance and its accessible parts become hot during use. Care should be taken to avoid touching heating elements. Children less than 8 years of age shall be kept away unless continuously supervised.

 During use the appliance becomes hot. Care should be taken to avoid touching heating elements inside the oven.

 **WARNING:** Accessible parts may become hot during use. Young children should be kept away.

 Steam cleaner is not to be used.

IMPORTANT SAFETY INSTRUCTIONS

 Do not use harsh abrasive cleaners or sharp metal scrapers to clean the oven door glass since they can scratch the surface, which may result in shattering of the glass.

 Eggs in their shell and whole hard-boiled eggs should not be heated in microwave ovens since they may explode, even after microwave heating has ended.

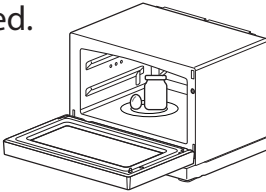

 The appliances are not intended to be operated by means of an external timer or separate remote-control system.

 The microwave oven shall not be placed in a cabinet unless it has been tested in a cabinet.

 Metallic containers for food and beverages are not allowed during microwave cooking.

 The appliance shall not be cleaned with a steam cleaner.

 The appliance must not be installed behind a decorative door in order to avoid overheating. (This is not applicable for appliances with decorative door.)

READ CAREFULLY AND KEEP FOR
FUTURE REFERENCE
HOUSEHOLD USE ONLY
(NOT FOR COMMERCIAL USE)

TO REDUCE THE RISK OF INJURY TO PERSONS GROUNDING INSTALLATION

This appliance must be grounded. In the event of an electrical short circuit, grounding reduces the risk of electric shock by providing an escape wire for the electric current.

This appliance is equipped with a cord having a grounding wire with a grounding plug. The plug must be plugged into an outlet that is properly installed and grounded.

WARNING - Improper use of the grounding can result in a risk of electric shock. Consult a qualified electrician or serviceman if the grounding instructions are not completely understood or if doubt exists as to whether the appliance is properly grounded. If it is necessary to use an extension cord, use only a 3-wire extension cord.



DANGER

Electric Shock Hazard:

Touching some of the internal components can cause serious personal injury or death. Do not disassemble this appliance.

TO REDUCE THE RISK OF INJURY TO PERSONS GROUNDING INSTALLATION



WARNING

Electric Shock Hazard:

Improper use of the grounding can result in electric shock. Do not plug into an outlet until appliance is properly installed and grounded.

1. A short power-supply cord is provided to reduce the risks resulting from becoming entangled in or tripping over a longer cord.
2. If a long cord or extension cord is used:
 - (1). The marked electrical rating of the cord set or extension cord should be at least as great as the electrical rating of the appliance.
 - (2). The extension cord must be a grounding-type 3-wire cord.
 - (3). The longer cord should be arranged so that it will not drape over the counter top or tabletop where it can be pulled on by children or tripped over unintentionally.

CLEANING

Be sure to unplug the appliance from the power supply.

1. Clean the cavity of the oven after using with a slightly damp cloth.
2. Clean the accessories in the usual way in soapy water.
3. The door frame and seal and neighbouring parts must be cleaned carefully with a damp cloth when they are dirty.
4. Do not use harsh abrasive cleaners or sharp metal scrapers to clean the oven door glass since they can scratch the surface, which may result in shattering of the glass.
5. Cleaning Tip---For easier cleaning of the cavity walls that the food cooked can touch: Place half a lemon in a bowl, add 300ml (1/2 pint) water and heat on 100% microwave power for 10 minutes. Wipe the oven clean using a soft, dry cloth.

UTENSILS



CAUTION

Personal Injury Hazard:

It is hazardous for anyone other than a competent person to carry out any service or repair operation that involves the removal of a cover which gives protection against exposure to microwave energy. See the instructions on "**Materials you can use in microwave oven**" or "**Materials can not be used in microwave oven**".

There may be certain non-metallic utensils that are not safe to use for microwaving. If in doubt, you can test the utensil in question following the procedure below.

Utensil Test:

1. Fill a microwave-safe container with 1 cup of cold water (250ml) along with the utensil in question.
2. Cook on maximum power for 1 min.
3. Carefully feel the utensil. If the empty utensil is warm, do not use it for microwave cooking.
4. Do not exceed 1 min cooking time.

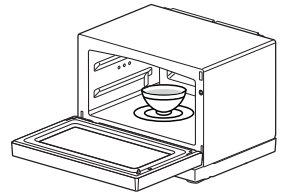





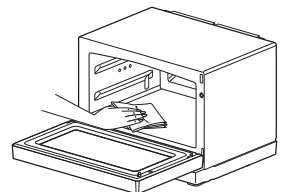











NOTE





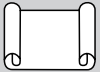



KEEP THE CAVITY AND WAVEGUIDE AREA CLEAN





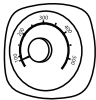











MATERIALS YOU CAN USE IN MICROWAVE OVEN

UTENSILS	REMARKS	
 Browning dish	Follow manufacturer's instructions. The bottom of browning dish must be at least 3/16 inch (5mm) above the turntable. Incorrect usage may cause the turntable to break.	
 Dinnerware	Microwave-safe only. Follow manufacturer's instructions. Do not use cracked or chipped dishes.	
 Glass jars	Always remove lid. Use only to heat food until just warm. Most glass jars are not heat resistant and may break.	
 Glassware	Heat-resistant oven glassware only. Make sure there is no metallic trim. Do not use cracked or chipped dishes.	
 Oven cooking bags	Follow manufacturer's instructions. Do not close with metal tie. Make slits to allow steam to escape.	
 Paper plates and cups	Use for short-term cooking/warming only. Do not leave oven unattended while cooking.	
 Paper towels	Use to cover food for reheating and absorbing fat. Use with supervision for a short-term cooking only.	
 Parchment paper	Use as a cover to prevent splattering or a wrap for steaming.	

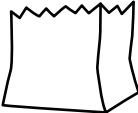
MATERIALS YOU CAN USE IN MICROWAVE OVEN

UTENSILS	REMARKS
 <p data-bbox="175 453 241 475">Plastic</p>	<p data-bbox="353 355 901 496">Microwave-safe only. Follow the manufacturer's instructions. Should be labeled "Microwave Safe". Some plastic containers soften, as the food inside gets hot. "Boiling bags" and tightly closed plastic bags should be slit, pierced or vented as directed by package.</p> 
 <p data-bbox="148 639 268 662">Plastic wrap</p>	<p data-bbox="353 555 901 639">Microwave-safe only. Use to cover food during cooking to retain moisture. Do not allow plastic wrap to touch food.</p> 
 <p data-bbox="135 804 281 826">Thermometers</p>	<p data-bbox="353 751 891 774">Microwave-safe only (meat and candy thermometers).</p> 
 <p data-bbox="157 963 259 986">Wax paper</p>	<p data-bbox="353 900 823 954">Use as a cover to prevent splattering and retain moisture.</p> 

MATERIALS CAN NOT BE USED IN MICROWAVE OVEN

UTENSILS	REMARKS
 Aluminum tray	May cause arcing. Transfer food into microwave-safe dish. 
 Food carton with metal handle	May cause arcing. Transfer food into microwave-safe dish. 
 Metal or metal trimmed utensils	Metal shields the food from microwave energy. Metal trim may cause arcing. 
 Metal twist ties	May cause arcing and could cause a fire in the oven. 
 Paper bags	May cause a fire in the oven. 
 Plastic foam	Plastic foam may melt or contaminate the liquid inside when exposed to high temperature. 
 Wood	Wood will dry out when used in the microwave oven and may split or crack. 

PRODUCT SETTING

NAMES OF MICROWAVE OVEN PARTS AND ACCESSORIES

Remove the oven and all materials from the carton and oven cavity.

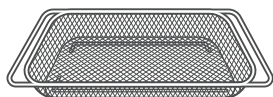
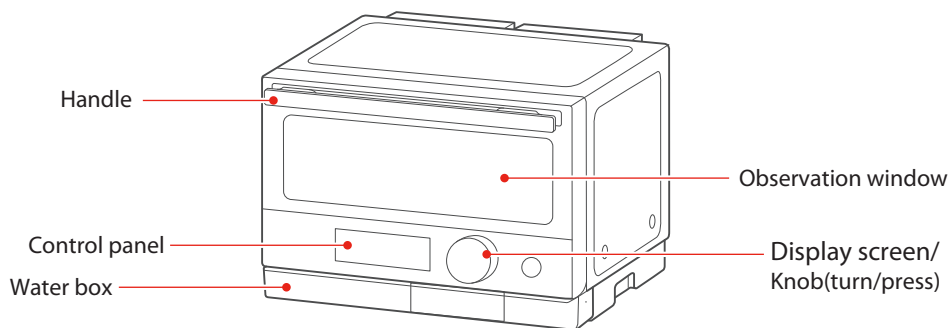

Air fry basket
(Can't be used in microwave cooking, place in the cavity slot, use for air fry cooking.)



Bake tray
(Can't be used in microwave cooking, place in the cavity slot, use for cooking foods that will drip during cooking.)

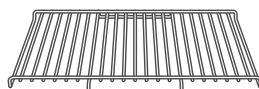

Bake rack
(Can't be used in microwave cooking, place directly on the bottom surface of the baking cavity or on the bake tray, use for grill, baking and steam cooking.)



In case of any differences between the appliance and the pictures in this manual, the product shall prevail.

WATER BOX USE

Pure water box
(Fill the box of pure water(<math><40^{\circ}\text{C}</math>
before steam and cleaning function.)

Dirty water box
(Use for catching the water dripping
from the cavity.)

Note: Please dump the unclean
water after cooking.

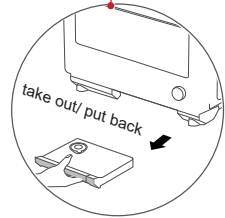
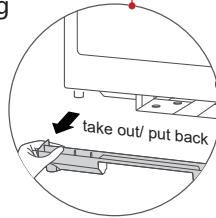
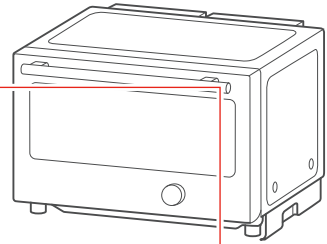

1. Water adding method

Method 1

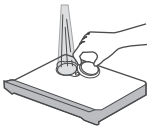

Uncover the rubber lid, add a proper amount of pure water, cover the rubber lid and ensure good fitting.

Method 2

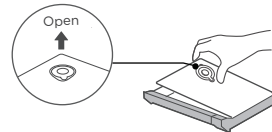

Uncover the pure water box lid, add a proper amount of pure water, cover the water box lid and ensure good fitting.

2. Water box cleaning method

01

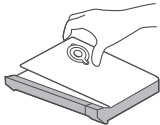

Uncover the pure water box lid to clean, or drain the remaining water.

02



Rinse the inside of the pure water box and dirty water box with water.

COUNTERTOP INSTALLATION

Remove all packing material and accessories. Examine the oven for any damage such as dents or broken door. Do not install if oven is damaged.

Cabinet: Remove any protective film found on the microwave oven cabinet surface. Do not remove the waveguide cover that is attached to the oven cavity to protect the magnetron.

INSTALLATION

1. Select a level surface that provide enough open space for the intake and/or outlet vents.
 - a. The minimum installation height is 85cm.
 - b. The rear surface of appliance shall be placed against a wall. Leave a minimum clearance of 30cm above the oven. A minimum clearance of 20cm is required between the oven and any adjacent walls.
 - c. Do not remove the legs from the bottom of the oven.
 - d. Blocking the intake and/or outlet openings can damage the oven.
 - e. Place the oven as far away from radios and TV as possible. Operation of microwave oven may cause interference to your radio or TV reception.

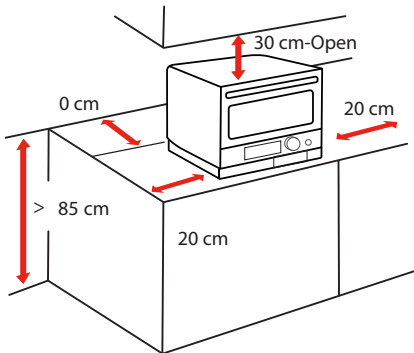

SIDE	DISTANCE CM
Top	30cm-Open
Left	20cm
Right	20cm
Behind	0cm
Front	Open

2. Plug microwave oven into a standard household outlet. Be sure the voltage and the frequency is the same as the voltage and the frequency on the rating label.



NOTE

- Do not install oven over a range cooktop or other heat-producing appliance. If installed near or over a heat source, the oven could be damaged and the warranty would be void.

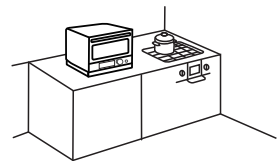

The accessible surface may be hot during operation



INSTRUCTION FOR USE

BEFORE USING FOR THE FIRST TIME

It is normal that the oven may produce unpleasant odors when it is used for the first time.

This section tells you what you need to do before using your microwave to prepare food for the first time. Read the section entitled "**PRODUCT SAFETY**" beforehand.



NOTE

You must clean the cooking compartment and accessories.

OPERATION

CONTROL PANEL AND FEATURES

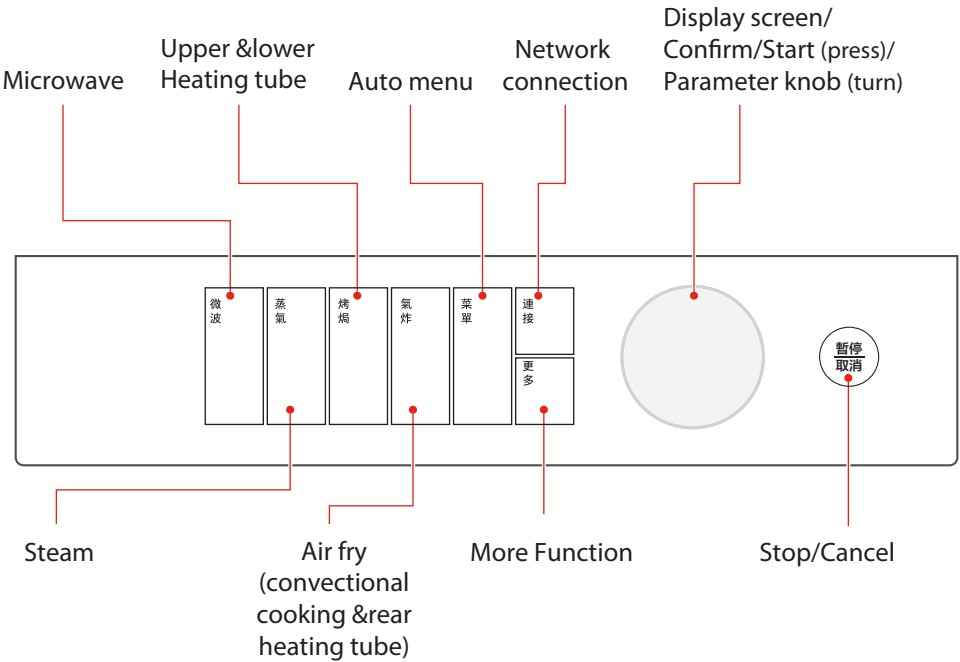

(You can also control the oven by app control)



NOTE

- App control: Download the TSmartLife first, then connect the app to your oven by the insert of TSmartLife APP connection guide.

1. MICROWAVE COOKING

Five power levels are available.

POWER	100%	80%	50%	30%	10%
DISPLAY	1000W	800W	500W	300W	100W

- a Press “微波” once and then “1000W” will display.

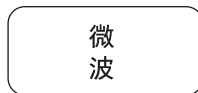

- b Turn the knob to set the power level.
The 5 power levels are available.

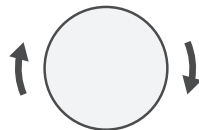

- c Press the knob to confirm.



- d Turn the knob to set the cooking time.
The maximum time value is “01時30分”.

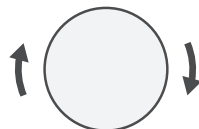

- e Press the knob to start cooking.



• The cooking time can be changed by turning the knob during operation.

App Control:



• To ensure safety, the APP remote control function is not allowed.

1 Tap the microwave icon to enter the cooking function setting page.

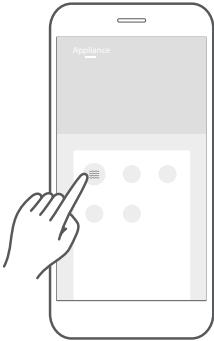

2 Swipe up and down to set the power level.

Tap this area to exit the cooking parameter tab and return to device function page.

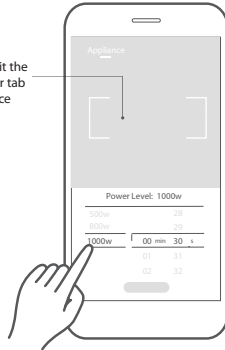

3 Swipe up and down to set the cooking time.

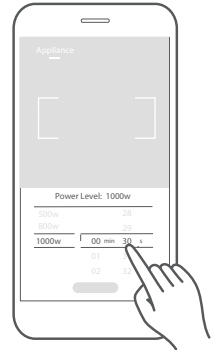

4 Tap "Start" to confirm.

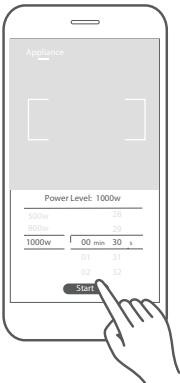

5 Please read the instructions and then tap "OK" to confirm.

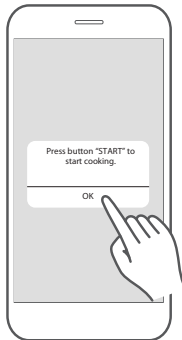

6 Please read the tips and tap "Start Now" to confirm. Then press the knob on the appliance to start cooking.

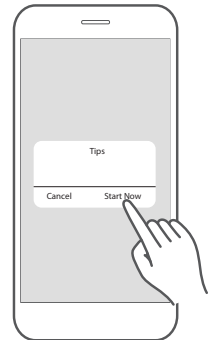

• Do not swipe too fast when sliding the wheel up and down to select parameters. Tap the "Start" button when the numbers stop scrolling.

2. STEAM COOKING

- a Press “蒸氣” once and then “純蒸” will display.

蒸氣

- b Press the knob to confirm.



- c Turn the knob to set the temperature, “50°C-100°C” are available.

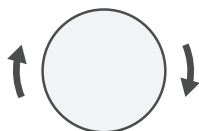

- d Press the knob to confirm.



- e Turn the knob to set the cooking time. The maximum time value is “01時30分”.

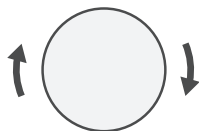

- f Press the knob to start cooking.



NOTE

- Before starting the steam cooking mode, please clean the water box and add pure water.
- The cooking time can be changed by turning the knob during operation.
- At the start of steam cooking, if the cavity temperature is too high, “爐溫過高 開門散熱” will display.
- In the steam cooking mode, when a water shortage is detected, the cooking process will automatically pause, the “水盒缺水 請加水” will display.

App Control:



NOTE

• To ensure safety, the APP remote control function is not allowed.

1 Tap the steam icon  to enter the cooking function setting page.

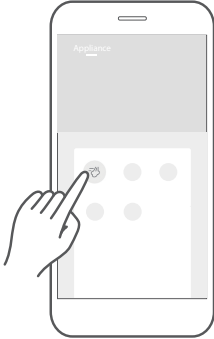

2 Swipe up and down to set the temperature.

Tap this area to exit the cooking parameter tab and return to device function page.

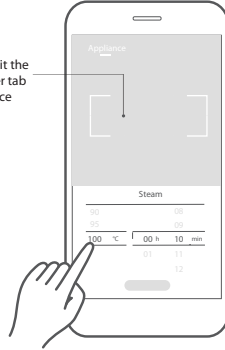

3 Swipe up and down to set the cooking time.

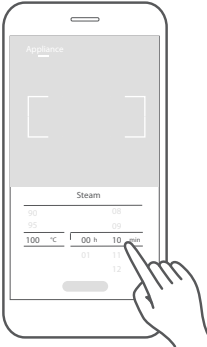

4 Tap "Start" to confirm, then press the knob on the appliance to start cooking.

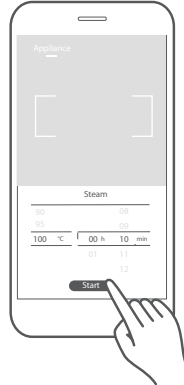

NOTE

• Do not swipe too fast when sliding the wheel up and down to select parameters. Tap the "Start" button when the numbers stop scrolling.

3. HIGH TEMP. STEAM COOKING

- a Press “蒸氣” once and then “純蒸” will display.

蒸氣

- b Turn the knob to choose the “高溫蒸”, and then press the knob to confirm.

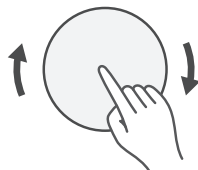

- c Turn the knob to set the temperature, “110°C-130°C” are available.

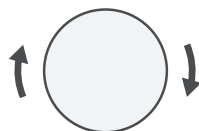

- d Press the knob to confirm.



- e Turn the knob to set the cooking time. The maximum time value is “01時30分”.

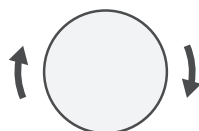

- f Press the knob to start cooking.



NOTE

- Before starting the steam cooking mode, please clean the water box and add pure water.
- The cooking time can be changed by turning the knob during operation.
- At the start of steam cooking, if the cavity temperature is too high, “爐溫過高 開門散熱” will display.
- In the steam cooking mode, when a water shortage is detected, the cooking process will automatically pause, the “水盒缺水 請加水” will display.

App Control:



• To ensure safety, the APP remote control function is not allowed.

- 1 Tap the high temp. steam icon  to enter the cooking function setting page.

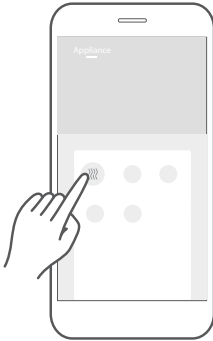

- 2 Swipe up and down to set the temperature.

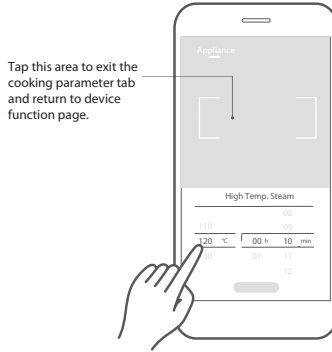

- 3 Swipe up and down to set the cooking time.

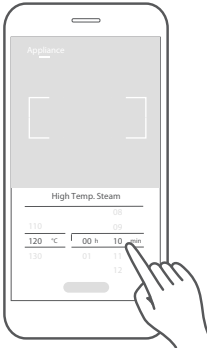

- 4 Tap "Start" to confirm, then press the knob on the appliance to start cooking.

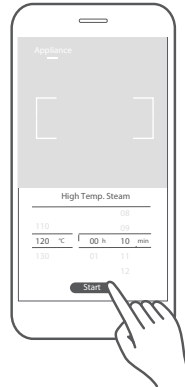

• Do not swipe too fast when sliding the wheel up and down to select parameters. Tap the "Start" button when the numbers stop scrolling.

4. SUPERHEATED STEAM COOKING WITHOUT PREHEAT FUNCTION—

- a Press “蒸氣” once and then “純蒸” will display.

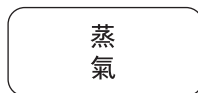

- b Turn the knob to choose the “過熱水蒸氣”, and then press the knob to confirm.

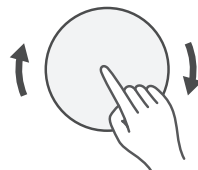

- c Turn the knob to set the temperature, “100°C-230°C” are available.

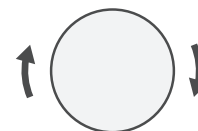

- d Press the knob to confirm.



- e Turn the knob to set the cooking time. The maximum time value is “01時30分”.



- f Press the knob to start cooking.



NOTE

- Before starting the steam cooking mode, please clean the water box and add pure water.
- The cooking time can be changed by turning the knob during operation.
- In the steam cooking mode, when a water shortage is detected, the cooking process will automatically pause, the “水盒缺水 請加水” will display.

5. SUPERHEATED STEAM COOKING WITH PREHEAT FUNCTION

- a Press “蒸氣” once and then “純蒸” will display.

蒸氣

- b Turn the knob to choose the “預熱+過熱水蒸氣”, and then press the knob to confirm.

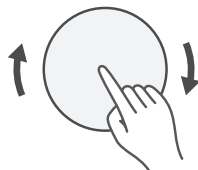

- c Turn the knob to set the temperature, “100°C-230°C” are available.

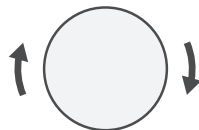

- d Press the knob to confirm.



- e Turn the knob to set the cooking time. The maximum time value is “01時30分”.

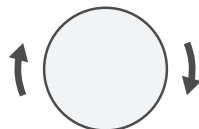

- f Press the knob to start preheating.



- g When preheating is completed, “預熱結束 請放入食物” will display. Open the door and place the food in the oven. Close the oven door, and then press the knob to start cooking.



NOTE

- Before starting the steam cooking mode, please clean the water box and add pure water.
- The cooking time can be changed by turning the knob during operation (except preheating).
- In the steam cooking mode, when a water shortage is detected, the cooking process will automatically pause, the “水盒缺水 請加水” will display.

App Control:



• To ensure safety, the APP remote control function is not allowed.

1 Tap the superheated steam cooking icon  to enter the cooking function setting page.

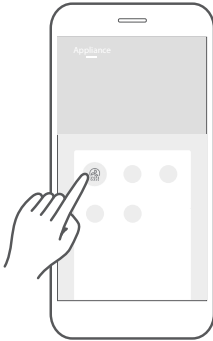

2 Swipe up and down to set the temperature.

Tap this area to exit the cooking parameter tab and return to device function page.

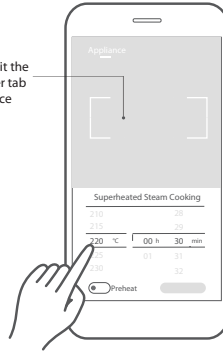

3 Swipe up and down to set the cooking time.

4 Tap the  icon to choose the preheating on/off.

5 Tap "Start" to confirm, then press the knob on the appliance to start cooking.

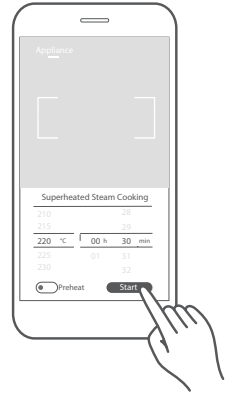
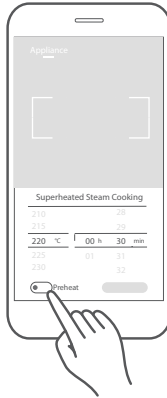
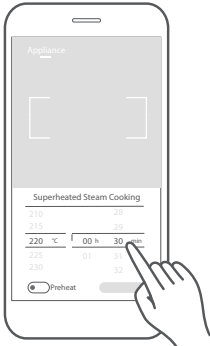

• Do not swipe too fast when sliding the wheel up and down to select parameters. Tap the "Start" button when the numbers stop scrolling.

6. ROASTING COOKING WITH PREHEAT FUNCTION

*cooking with upper & lower heating tube Roast

- a Press “烤焗” once and then “預熱” will display.
- b Press the knob to confirm. And then turn the knob to set the temperature, “100°C-230°C” are available.
- c Press the knob to start preheating.
- d When preheating is completed, “預熱結束” will display. Open the door and place the food in the oven. Close the oven door, and “烤焗” will display. And then press the knob to confirm.
- e Turn the knob to set the temperature, “100°C-230°C” are available. And then press the knob to confirm.
- f Turn the knob to set the cooking time. The maximum time value is “01時30分”.
- g Press the knob to start cooking.

烤焗

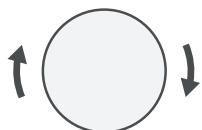
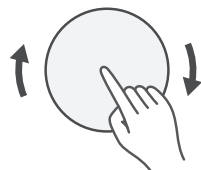
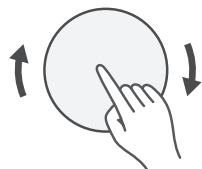

NOTE

- After preheating is complete, if “暫停取消” is pressed or if there is no operation within 30 minutes, the oven will enter the setting of the “烤焗”.
- The cooking time can be changed by turning the knob during operation (except preheating).

7. ROASTING COOKING WITHOUT PREHEAT FUNCTION

*cooking with upper & lower heating tube Roast

烤
焗

a Press “烤焗” once and then “預熱” will display.

b Turn the knob to choose the “烤焗”, and then press the knob to confirm.

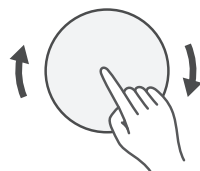

c Turn the knob to set the temperature, “100°C-230°C” are available.

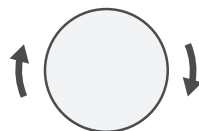

d Press the knob to confirm.



e Turn the knob to set the cooking time. The maximum time value is “01時30分”.

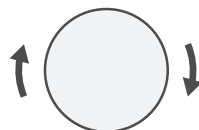

f Press the knob to start cooking.



NOTE

• The cooking time can be changed by turning the knob during operation.

App Control:



• To ensure safety, the APP remote control function is not allowed.

- 1 Tap the conventional icon  to enter the cooking function setting page.

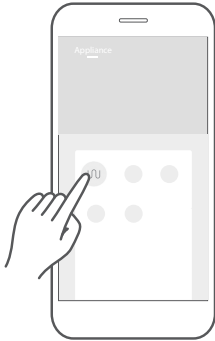

- 2 Swipe up and down to set the temperature.

Tap this area to exit the cooking parameter tab and return to device function page.

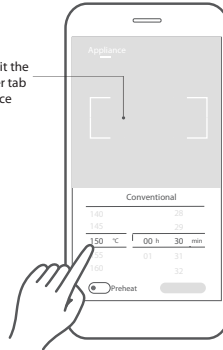

- 3 Swipe up and down to set the cooking time.

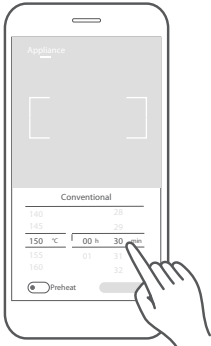

- 4 Tap the  icon to choose the preheating on/off.

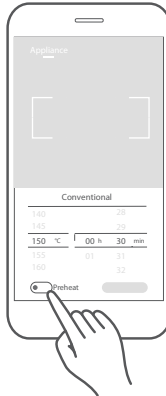

- 5 Tap "Start" to confirm, then press the knob on the appliance to start cooking.

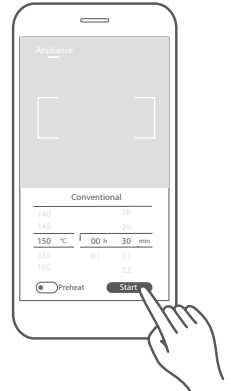

• Do not swipe too fast when sliding the wheel up and down to select parameters. Tap the "Start" button when the numbers stop scrolling.

8. AIR FRY WITH PREHEAT FUNCTION

*convectonal cooking with rear heating tube

氣炸

- a Press “氣炸” once and then “預熱” will display.
- b Press the knob to confirm. And then turn the knob to set the temperature, “100°C-230°C” are available.
- c Press the knob to start preheating.
- d When preheating is completed, “預熱結束” will display. Open the door and place the food in the oven. Close the oven door, and “氣炸” will display. And then press the knob to confirm.
- e Turn the knob to set the temperature, “100°C-230°C” are available. And then press the knob to confirm.
- f Turn the knob to set the cooking time. The maximum time value is “01時30分”.
- g Press the knob to start cooking.

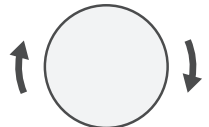
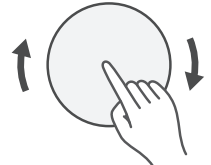
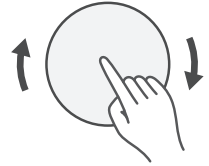

NOTE

- After preheating is complete, if “暫停取消” is pressed or if there is no operation within 30 minutes, the oven will enter the setting of the “氣炸”.
- The cooking time can be changed by turning the knob during operation (except preheating).

9. AIR FRY WITHOUT PREHEAT FUNCTION

***convectional cooking with rear heating tube**



a Press “氣炸” once and then “預熱” will display.

b Turn the knob to choose the “氣炸”, and then press the knob to confirm.

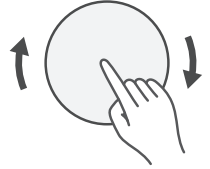

c Turn the knob to set the temperature, “100°C-230°C” are available.

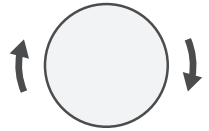

d Press the knob to confirm.



e Turn the knob to set the cooking time. The maximum time value is “01時30分”.

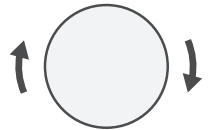

f Press the knob to start cooking.



NOTE

• The cooking time can be changed by turning the knob during operation.

App Control:



• To ensure safety, the APP remote control function is not allowed.

1 Tap the air fry icon  to enter the cooking function setting page.

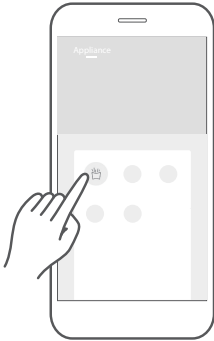

2 Swipe up and down to set the temperature.

Tap this area to exit the cooking parameter tab and return to device function page.

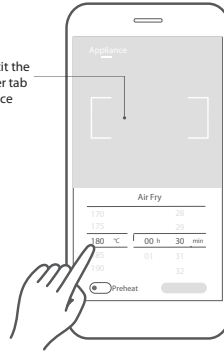

3 Swipe up and down to set the cooking time.

4 Tap the  icon to choose the preheating on/off.

5 Tap "Start" to confirm, then press the knob on the appliance to start cooking.

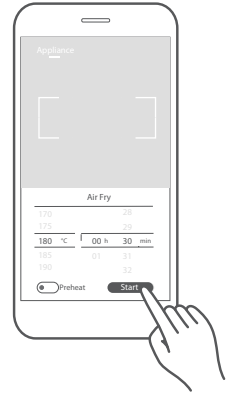
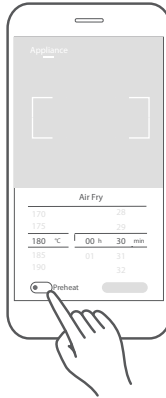
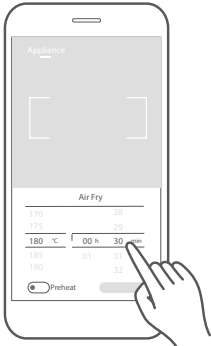

• Do not swipe too fast when sliding the wheel up and down to select parameters. Tap the "Start" button when the numbers stop scrolling.

10. AUTO MENU

- a Press “**菜單**” once and then “炸蝦天婦羅” will display.

菜單

- b Turn the knob to select the desired menu.
The 47 auto menus are available.

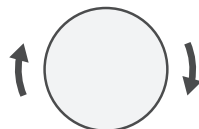

- c Press the knob to confirm.



- d Turn the knob to adjust the cooking time.

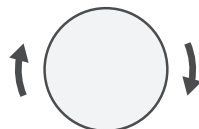

- e Press the knob to start cooking.



NOTE

• For the menus “3, 10, 31, 32, 33, 34, 35, 40”, the buzzer will sound to remind you to turn over or stir the food, or add some ingredients during cooking. You must press the knob to continue cooking.

MENU CHART

MENU	WEIGHT/AMOUNT (Recommended)	DEFAULT TIME	POWER
1 Shrimp Tempura	400g	07分	Air Fry 200°C
2 Tonkatsu	500g	25分	Air Fry 220°C
3 Grilled Saury	300g	15分	Conventional 200°C (with preheat)
4 Grilled Shishamo	250g	20分	Air Fry 230°C
5 Chawanmushi	600g	20分	Steam 100°C
6 Steamed Shrimps with Japanese Tofu	500g	10分	Steam 100°C
7 Hamburg Steak	600g	20分	Conventional 220°C (with preheat)
▶ 8 Nikujaga	1000g	01時10分	Microwave 1000W+500W
9 Honey Baked Chicken Wings	500g	24分	Conventional 200°C (with preheat)
10 Grilled Steak with Black Pepper	500g	07分	Conventional 230°C (with preheat)
11 Grilled Shrimps with Salt & Pepper	400g	09分	Air Fry 200°C
12 Korean-style Grilled Squid	750g	07分	Conventional 230°C (with preheat)
▶ 13 Braised Beef Brisket with Radish	1000g	01時10分	Microwave 1000W+500W
14 Steamed Fish Head with Chopped Chili Pepper	600g	20分	Steam 100°C
▶ 15 Spicy Pork Trotter	1000g	01時10分	Microwave 1000W+500W
16 Sichuanese Grilled Cod	250g	10分	Conventional 230°C (with preheat)
▶ 17 Dong Pei Big Bone	1000g	01時10分	Microwave 1000W+500W
18 Spicy & Sour Chicken Feet	500g	30分	Steam 100°C
19 Steamed Baby Chinese Cabbage with Minced Garlic	400g	13分	Steam 100°C
20 Steamed Sea Bass with Lemon	500g	15分	Steam 100°C
21 Steamed Hairy Crabs	600g	18分	Steam 100°C
22 Siu Mai	200g	15分	Steam 100°C
23 Steamed Chicken with Red Dates & Goji Berry	500g	20分	Steam 100°C
24 Grilled Vegetable	350g	20分	Conventional 180°C
▶ 25 Scallops Mixed with Melon	200g	05分	Microwave 1000W
26 Steamed Conger Eel	700g	18分	Steam 100°C

MENU CHART

MENU	WEIGHT/AMOUNT (Recommended)	DEFAULT TIME	POWER
27 Grilled Sweet Potato	1000g	50分	Air Fry 230°C
28 French Fries	500g	20分	Air Fry 200°C
29 Fried Chicken Drumsticks	500g	23分	Air Fry 220°C
30 Fried Crispy Pork Slices	350g	20分	Air Fry 220°C
31 Fried Chicken Fillets	350g	20分	Air Fry 190°C
32 Honey Baked Chicken Legs	900g	40分	Air Fry 200°C
33 Grilled Sausages	300g	13分	Air Fry 160°C
34 Honey Roasted Chestnut	500g	15分	Air Fry 200°C
35 Deep-fried Peanuts	300g	23分	Air Fry 160°C
36 Oatmeal Shrimps	550g	12分	Air Fry 180°C
37 Portuguese Egg Tart	9 pieces	23分	Air Fry 180°C (with preheat)+ Conventional 220°C
38 Chiffon Cake	8 inches	50分	Air Fry 150°C+ 130°C+140°C (with preheat)
39 Cranberry Cookies	12 pieces	23分	Air Fry 140°C +160°C (with preheat)
40 Toast Bread	500g	40分	Conventional 160°C (with preheat)
41 Cupcakes	350g	17分	Conventional 170°C (with preheat)
42 Croissant	350g	15分	Conventional 160°C (with preheat)
43 Caramel Pudding	800g	20分	Conventional 140°C (with preheat)
44 Seafood Pizza	750g	18分	Conventional 180°C (with preheat)
45 Thin Crust Pizza	600g	16分	Conventional 180°C +200°C (with preheat)
46 Sweet Green Rice Ball	600g	15分	Steam 100°C
▶ 47 Chilled Mango Sago Cream with Pomelo	500g	13分	Microwave 1000W

App Control:



NOTE

- To ensure safety, the APP remote control function is not allowed.

- 1 Tap the menu icon to enter the auto menu function setting page. And then you can tap "Recipe" to open the related recipe.

Tap this area to exit the cooking parameter tab and return to device function page.

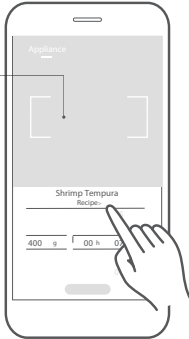

- 2 Swipe up and down to set the cooking time.

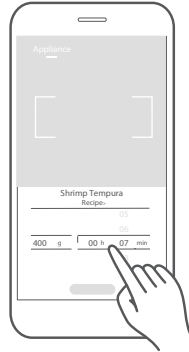

- 3 Tap "Start" to confirm, then press the knob on the appliance to start cooking.

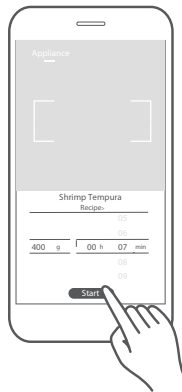

NOTE

- Do not swipe too fast when sliding the wheel up and down to select parameters. Tap the "Start" button when the numbers stop scrolling.

11. WIRELESS CONNECTION

Connect the network:

- a** Press “**連接**” once and then “未連接網絡” will display.

連接

- b** Press the knob once, “請打開App TSmartLife” will display.
And then open the TSmartLife App to connect the network.
If the network connection is successful, “網絡已連接” will display.
Otherwise, “未連接網絡” will display.



Disconnect from the network:

- a** Press “**連接**” once and then “網絡已連接” will display.

連接

- b** Press the knob once, “確認重置連接?” will display.



- c** Press the knob again to confirm.
If the link has been removed successfully, the screen will display “重置成功”. If it fails, “重置失敗” will display.



12. DEFROST

- a Press “ 更多 ” once and then “解凍” will display.

更多

- b Press the knob to confirm.



- c Turn the knob to set the weight of the food.
The range of weight is 100 to 1500g.

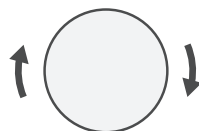

- d Press the knob to start defrosting.



NOTE

- The buzzer will sound to remind you to turn over the food during defrosting. If no operation, the oven will continue working.

App Control:



NOTE

• To ensure safety, the APP remote control function is not allowed.

1 Tap the defrost icon  to enter the cooking function setting page.

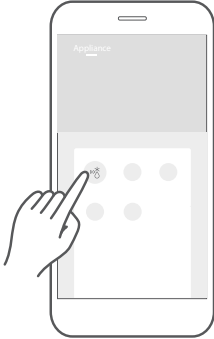

2 Swipe up and down to set the weight of the food.

Tap this area to exit the cooking parameter tab and return to device function page.

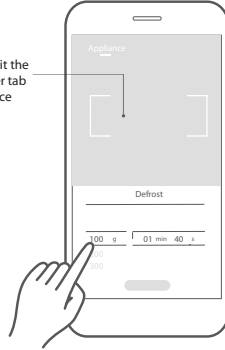

3 Tap "Start" to confirm.

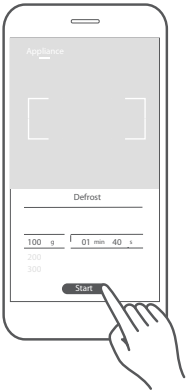

4 Please read the instructions and then tap "OK" to confirm.

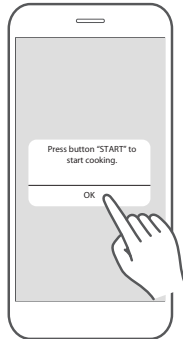

5 Please read the tips and tap "Start Now" to confirm. Then press the knob on the appliance to start cooking.

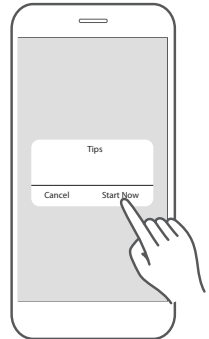

NOTE

• Do not swipe too fast when sliding the wheel up and down to select parameters. Tap the "Start" button when the numbers stop scrolling.

13. FERMENTATION

- a Press “更多” once and then “解凍” will display.

更多

- b Turn the knob to choose the “發酵”, and then press the knob to confirm.

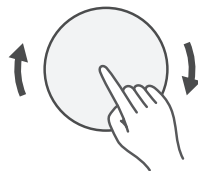

- c Turn the knob to set the temperature, “25°C-45°C” are available. And then press the knob to confirm.

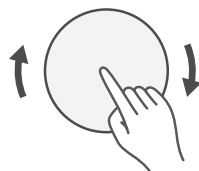

- d Turn the knob to set the cooking time. The maximum time value is “12時”.

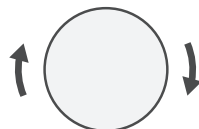

- e Press the knob to start fermenting.



NOTE

- The cooking time can be changed by turning the knob during operation.
- At the start of fermenting, if the cavity temperature is over 50°C, “爐溫過高 開門散熱” will display.

App Control:



- To ensure safety, the APP remote control function is not allowed.

- 1 Tap the fermentation icon  to enter the cooking function setting page.

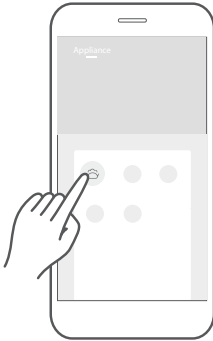

- 2 Swipe up and down to set the temperature.

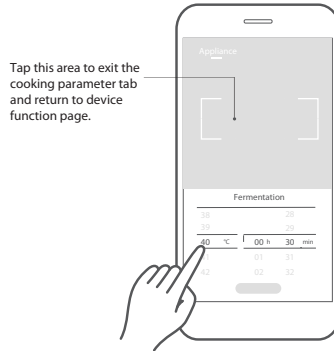

- 3 Swipe up and down to set the cooking time.

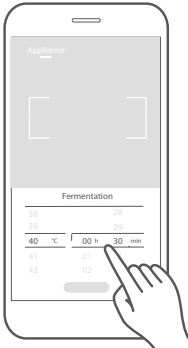

- 4 Tap "Start" to confirm, then press the knob on the appliance to start cooking.

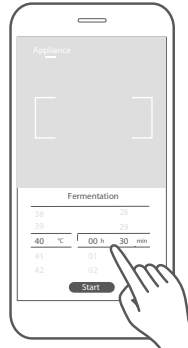

- Do not swipe too fast when sliding the wheel up and down to select parameters. Tap the "Start" button when the numbers stop scrolling.

14. KEEP WARM

- a Press “ 更多 ” once and then “解凍” will display.

更多

- b Turn the knob to choose the “保溫”, and then press the knob to confirm.

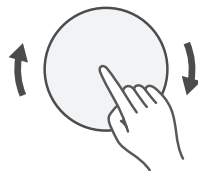

- c Turn the knob to set the cooking time.
The maximum time value is “02時”.

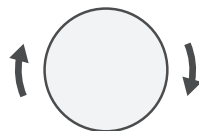

- d Press the knob to start keeping warm.



NOTE

- The cooking time can be changed by turning the knob during operation.
- The keep warm function operates at the conventional 60°C to maintain the food's warmth after cooking.

15. STERILIZATION

- a Press “更多” once and then “解冻” will display.

更多

- b Turn the knob to choose the “除菌”, and then press the knob to confirm.

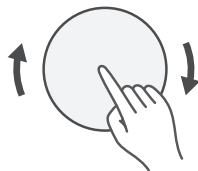

- c Turn the knob to set the cooking time.
The maximum time value is “01時30分”.

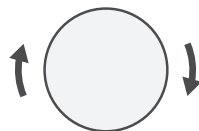

- d Press the knob to start working.



NOTE

- The cooking time can be changed by turning the knob during operation.
- The sterilization function operates at the steam 100°C.

16. OVEN DRY

- a Press “更多” once and then “解凍” will display.

更多

- b Turn the knob to choose the “烘乾”, and then press the knob to confirm.

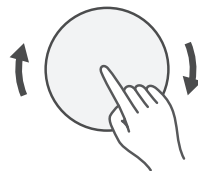

- c Turn the knob to set the cooking time.
The maximum time value is “01時30分”.

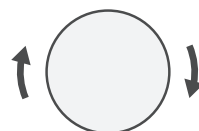

- d Press the knob to start working.



NOTE

- The cooking time can be changed by turning the knob during operation.
- The oven dry function operates at the air fry 120°C.

17. DEODORIZATION

- a Press “ 更多 ” once and then “解冻” will display.

更多

- b Turn the knob to choose the “除味”, and then press the knob to confirm.

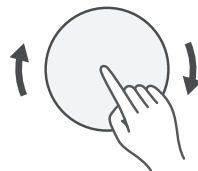

- c Turn the knob to set the cooking time.
The maximum time value is “10分”.

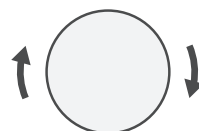

- d Press the knob to start working.



NOTE

• The cooking time can be changed by turning the knob during operation.

18. CLEANING

- a Press “更多” once and then “解冻” will display.

更多

- b Turn the knob to choose the “清潔”, and then press the knob to confirm.

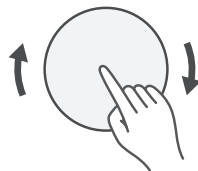

- c Turn the knob to set the cooking time.
The maximum time value is “30分”.

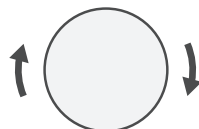

- d Press the knob to start working.



NOTE

- The cooking time can be changed by turning the knob during operation.
- The cleaning function operates at the steam 100°C.
- Before operating, pour over a rag with clean water and then wipe the residue from the cavity and keep the water box full of water.
- After the end of the cleaning need to clean out the stains with a rag.

19. DESCALING

- a Take out the water box, add about 10g of food-grade citric acid, fill up with pure water to dissolve it, and put the water box back.

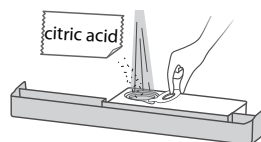

- b Put a dry towel on the left side of the oven cavity, on the steam outlet. Then close the oven door.

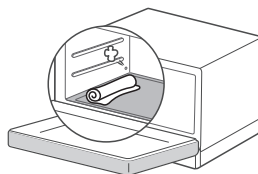

- c Press "更多" once and then "解冻" will display.

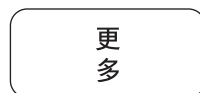

- d Turn the knob to choose the "除垢", and then press the knob to start working.

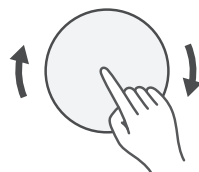

- e When "請抹乾爐腔 重新換水" displays and the program is paused, empty the water box, dry the oven cavity, and clean the towel. Refill the water box with water and place the towel under the steam outlet again.

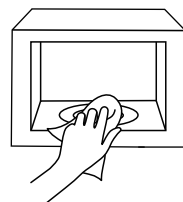

- f Press the knob to continue working.



NOTE

- It is best to clean the evaporating flume once a month.
- After the end of the cleaning need to dry the oven cavity with a rag.

App Control:



- To ensure safety, the APP remote control function is not allowed.

For the functions “keep warm, sterilization, oven dry, deodorization, cleaning” :

- 1 Tap the keep warm icon  to enter the function setting page.
- 2 Swipe up and down to set the time.
- 3 Tap "Start" to confirm, then press the knob on the appliance to start cooking.

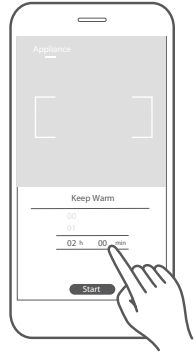
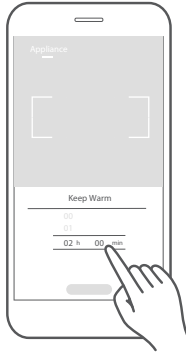
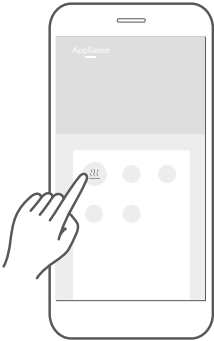

For the function “Descaling” :

- 1 Tap the descaling icon  to enter the function setting page.
- 2 Tap "Start" to confirm, then press the knob on the appliance to start cooking.

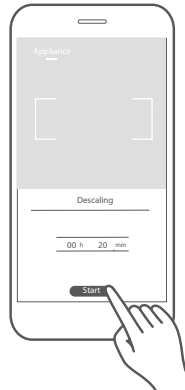
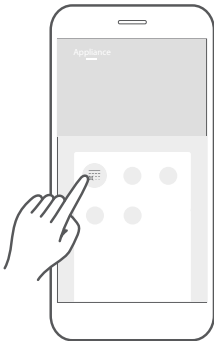

- Do not swipe too fast when sliding the wheel up and down to select parameters. Tap the "Start" button when the numbers stop scrolling.

20. ECO FUNCTION

- a** To enter ECO mode:

In standby mode, press “” once, or if there is no operation within five minutes, the screen will turn off.



- b** To cancel ECO mode:

In ECO mode, pressing any key, turning the knob, or opening the door will cancel it.



NOTE

- When there is no operation within five minutes after the screen turns off, the oven will enter the “0W” mode. In the “0W” mode, you must open the oven door to cancel it, and then the oven will enter the standby mode.

App Control:



NOTE

- To ensure safety, the APP remote control function is not allowed.

RECIPES

The Recipes page displays cloud recipes, and cooking parameters have been verified by professional chefs. The recipe page is continuously being updated to provide more cooking variety.

- 1** Tap the recipe picture to enter the recipe details page.

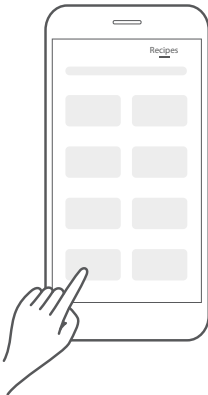

- 2** Swipe up and down to view the required ingredients and detailed cooking steps. Tap “Cook Now” to confirm, then press the knob on the appliance to start cooking.

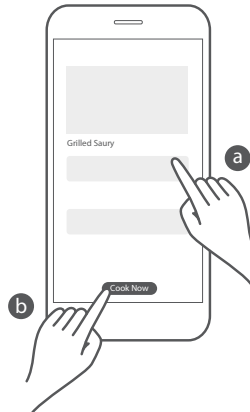

FAQ

1 Q: Does the home appliance support 5G wireless routers?

A: This product does not support wireless routers in the 5G frequency band. Please ensure that the mobile phone is connected to the 2.4G wireless network before networking the home appliance.

2 Q: Why do I need to turn on the Bluetooth of my mobile phone before networking?

A: Turning on the Bluetooth of the mobile phone can improve the success rate of networking and avoid the failure of the home appliance networking.

3 Q: How many family members are allowed to use the APP at most for the same appliance?

A:

- 1) A home appliance only allows one account to be associated. If a new account is used to bind this home appliance, the previous account will be forced to disassociate and can't be used.
- 2) You can use the sharing function in the APP to grant permissions to use the home appliance to the users who need it, enter My Setup-My devices, select the device to be shared, and tap the button at the bottom of the APP to add the sharing user
- 3) There is no limit to the number of sharing users. The users shared to have all the operating permissions of the home appliance. Please use this function with caution
- 4) After the sharing user deletes the home appliance, the home appliance of the user shared is automatically deleted from the APP. If the user shares to delete the home appliance, it is only deleted from its account, without affecting other users.

4 Q: Why the product can't be searched by model in the APP?

A:

- 1) Check whether the region on the APP setting page is the same as the purchase region. If the address information is incorrect, the model can't be displayed.
- 2) If the area of the APP setting page is correct, contact the after-sales service or ask for assistance through the help portal on the APP.

CLEANING AND MAINTENANCE

CLEANING

With good care and cleaning, your appliance will retain its appearance and remain fully functioning for a long time to come. We will explain here how you should correctly care for and clean your appliance.



WARNING

- Scratched glass in the appliance door may develop into a crack. Do not use a glass scraper, sharp or abrasive cleaning aids or detergents.
- The surface of the appliance may become damaged if it is not cleaned properly. Microwave energy may escape. Clean the appliance on a regular basis, and remove any food remnants immediately.
- Do not immerse the appliance in water or clean under a jet of water.

Cleaning agent

To ensure that the different surfaces are not damaged by using the wrong cleaning agent, observe the information in the table. Wash new sponge cloths thoroughly before use.

Do not use:



Harsh or abrasive cleaning agents



Metal or glass scrapers to clean the door panels

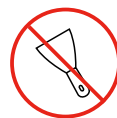

Metal or glass scrapers to clean the door seal



Hard scouring pads or sponges



Cleaning agents with a high alcohol content

APPLIANCE FRONT

Hot soapy water:

Clean using a dish cloth and then dry with a soft cloth. Do not use metal or glass scrapers for cleaning.

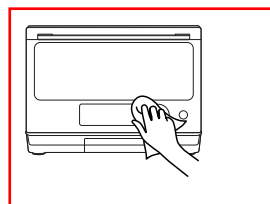

APPLIANCE FRONT WITH STAINLESS STEEL

Hot soapy water:

Clean using a dish cloth and then dry with a soft cloth. Remove splashes and patches of limescale, grease, starch and albumin immediately. Corrosion can form under these patches or splashes. Do not use glass cleaners or metal or glass scrapers for cleaning.



COOKING COMPARTMENT MADE OF STAINLESS STEEL

Hot soapy water or vinegar solution:

Clean using a dish cloth and then dry with a soft cloth. Do not use oven spray or any other aggressive oven cleaners or abrasive materials. Scouring pads, rough sponges and pan cleaners are also unsuitable. These items scratch the surface. Allow the interior surfaces to dry completely.

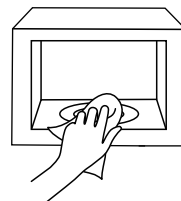

DOOR PANELS

Glass cleaner:

Clean with a dish cloth. Do not use glass scrapers.

TROUBLE SHOOTING

Normal	
Microwave oven interfering TV reception	Radio and TV reception may be interfered when microwave oven operating. It is similar to the interference of small electrical appliances, like mixer, vacuum cleaner, and electric fan. It is normal.
Dim oven light	In low power microwave cooking, oven light may become dim. It is normal.
Steam accumulating on door, hot air out of vents	In cooking, steam may come out of food. Most will get out from vents. But some may accumulate on cool place like oven door. It is normal.
Oven started accidentally with no food in.	It is forbidden to run the unit without any food inside. It is very dangerous.

Trouble	Possible Cause	Remedy
Oven cannot be started.	(1) Power cord is not plugged in tightly.	Unplug. Then plug again after 10 seconds.
	(2) Fuse blowing or circuit breaker works.	Replace fuse or reset circuit breaker (repaired by professional personnel of our company)
	(3) Trouble with outlet.	Test outlet with other electrical appliances.
Oven does not heat.	(4) Door is not closed well.	Close door well.

#DetailsMatter