



Instructions for safety

Please follow these instructions without fail

These instructions include important information for safe and correct usage in order to prevent damage to people and property.

■ Hazards and damage caused by failure to observe instructions for using this product are classified according to their degree, and are indicated by the following safety icons.

 **WARNING** This indicates that incorrect use may result in death or severe injury to the user.

 **CAUTION** This indicates that incorrect use may result in injury to the user or property damage.

■ Instructions to be observed are indicated according to the following classifications.

 Shows things you are prohibited from doing.

 Shows instructions you need to observe.

 Shows notes you need to pay attention to.

 **WARNING** To avoid fire, burn, electric shock, electrical leak, short circuit, etc.

 **This product should not be used by the following persons:**

- Children;
- Those who have less physical, perceptual, or intellectual ability; and
- Those who do not have sufficient experience and knowledge (including babies and children).

Please make sure to prevent babies and children from playing with this product, and put it out of the reach of babies and children.

 **Do not use the product inappropriately or for any other purpose than those described in the instruction manual.**

It may cause fire, burns, injury or electric shock. Toshiba is not responsible for any harm that may occur if the product is used inappropriately or for any purpose not described in this manual.

 **Stop using the product immediately if it malfunctions or breaks down.**

Immediately unplug the power plug, and contact the shop from which the product was purchased.

《Examples of malfunction or breakdown》

- The power plug or cord becomes abnormally hot.
- The main body smells like something burning.
- The main body is partly cracked, loose or rattling.
- The inner pot, outer lid or inner lid is deformed or damaged.
- The bottom fan is not running during cooking.

 **Do not attempt to disassemble, repair or modify the product.**

For repairs, contact the store from which the product was purchased.





 **Do not immerse the main body, the power plug and the power cord in water, pour water over them or wash them in water. Do not pour water or liquids into the cooker.**

 **Do not put foreign objects into the air inlet, air outlet or any gap.**

Especially metal objects such as pins, wire, etc.



 **Do not allow persons unfamiliar with its use or children to use the cooker and keep it out of the reach of children. In particular, keep a good eye on children when rice is being cooked and directly after it has cooked.**

 **Do not open the outer lid of the product or move or carry the product when it is in operation.**

⚠ WARNING To avoid fire, burn, electric shock, electrical leak, short circuit, etc.

Use the power plug, power cord and electrical outlet correctly.



Do not allow pins or dust to adhere to the power plug (power supply side/main body side).

Do not use if the power plug (power supply side/main body side) or the power cord is damaged and/or the power plug does not fit into an electrical outlet.

Always replace the damaged power cord with the specified one.

Do not use a power cord other than the specified one.

Do not use the power cord for other appliances.

Do not damage the power plug and cord.

Do not forcibly bend, pull, twist, or pinch the cord, do not bundle it during power distribution, do not place cord near hot parts of the appliance, do not place heavy objects on the cord, and do not modify the cord in any way.

Do not allow children to lick the power plug (power supply side/main body side).

Make sure that children and infants do not lick the power plug.



No wet hands.

Do not plug or unplug the power plug (power supply side/main body side) with wet hands.

Ensure that your hands are dry before touching the plug.



Plug the product into a 220V AC outlet with a rating of 10A or more. Do not share the outlet with other appliances.

Sharing the outlet with another appliance may cause a fire due to heat generation.

In case of using an extension cord, use the one rated at 10A or more. Do not share it with other appliances.

Plug in the power plug (power supply side / main body side) fully.

Regularly remove dust from the power plug (power supply side/main body side).

If dust accumulates on the power plug and becomes damp, this may cause insulation failure and lead to a fire. Wipe off dust with a dry cloth.

Make sure that the power cord is out of reach of children.

Do not allow the cord to dangle from a table or counter. If the cord is pulled, the product may fall from the table or counter and cause injury.

Be sure not to stumble or trip on the power cord when the cooker is in use.

It may cause injury, or the cord may become damaged and cause a fire or electric shock.

Use a properly earthed outlet.

The power plug of this product is designed to be used with an earthed outlet. If the outlet is not properly earthed, it may cause malfunction or electrical shock due to electrical leaks.



Do not touch.

Do not put your hands above or move your face near the steam vent. The steam vent is extremely hot.

In particular, keep the cooker out of the reach of babies or children.



Ensure to close the outer lid until it clicks.



Do not use the product for any other purpose than those described in the instruction manual.

As steam or contents may come out or boiling-over can be caused, you may get burnt or injured.

《Examples of items not to be used》

- Do not place any item that would block the steam port;
- Foods that expand after cooking such as fish pastes, steamed beans and noodles;
- Foods using baking soda or other ingredients that bubble rapidly;
- Thick foods such as curry and stews;
- Foods using a large amount of oil;
- Foods that can easily boil over, e.g. beans, jam, etc.;
- Heating of foods in a plastic bag with the rice cooker; and
- Steaming of foods while cooking rice or congee.

Instructions for safety

Please follow these instructions without fail



CAUTION

To prevent an injury, burn, electric shock, electrical leak, fire and property damage.

Do not use at any of the following places



A place exposed to water or close to fire.

Be careful with the accessories as well.

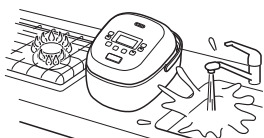

An unstable place or on a mat which easily catches fire.

It may cause burns, injury or fire.

A place where the air inlet / outlet will be blocked.

On paper, fabric, carpet, plastic bags, etc.

On aluminum sheet or an electric carpet.

The aluminum sheet may generate heat.



A place near walls and furniture.

If you are using the cooker in a kitchen storage shelf, etc., ensure that the steam does not come in contact with the operation panel or build up within the shelf. A sliding table-type drawer should be pulled out when using the cooker.

This may cause discoloration, deformation, or other damage.

On a sliding table with insufficient load strength.

Use the table with load strength of 15 kg or more for the 1.0 L type, and 20 kg or more for the 1.8 L type.

A place where the outer lid cannot be fully opened.

It may cause burns or damage.

A place near curtains that are not heatproof.

Do not use the cooker outdoors.

To prevent injuries and burns



Do not touch.

Do not touch the hot parts (the inner lid, inner pot, steam vent, heating plate, frame, etc.) during use and for a while after use.

Be careful not to touch the inner lid or inner pot with hand when loosening the rice after it has cooked.



Do not touch the open button when carrying the main body. Do not hold the rice cooker by the outer lid when carrying it.

Do not use the cooker while the inner pot is empty.

It may cause failure, overheating or malfunction.

Do not shake the appliance while holding the handle.

Do not raise the handle while rice is being cooked.



Use a dry cloth or mitten to remove the inner pot when it is still hot.

Do not touch it directly with your hands.

Before cleaning the cooker, unplug the power plug and wait until the cooker has cooled.

Watch out for steam coming out of the cooker and hot water droplets falling from the inner lid when opening the outer lid after cooking.



CAUTION

To prevent an injury, burn, electric shock, electrical leak, fire and property damage.

For safe use of the product



If you use a heart pacemaker, consult a doctor before using this product.

The operation of this product may affect pacemakers.



Do not use a deformed inner pot or an unspecified one.

It may cause burns or injury due to overheating or abnormal behavior.

Do not apply steam to the power plug and other electrical appliances.

Be especially careful when placing the product on a kitchen shelf, etc.

Do not use the cooker if there are any small metallic objects or aluminum foils, etc. in it.

Aluminum foils, etc. become extremely hot.



Hold the power plug (power supply side/main body side) when unplugging it from the electrical outlet or the main body.

It may cause an electric shock or catch fire due to a short circuit.

Do not pull the cord.

Unplug the power plug (power supply side) from an electrical outlet when the product is not in use.

Otherwise the insulation may deteriorate and result in an electric shock or fire due to an electrical leak.



Do not use the product for purposes other than home use (such as use in stores for an extended period of time or use by an unspecified number of people).

Failure to do so may cause a damage to the product, smoke emission or fire.

To prevent boiling over



Do not use any cooking courses other than those specified, such as <Quick 快煮>, when making congee, brown rice, or soup, which require more water.

Use the <Congee 粥> course for congee.



Do not increase the amount of water too much.

The allowable additional amount of water is up to 2 mm over the regular water level scale as a guide.

Do not add water exceeding the MAX water level on the inner pot for cooking.

Attention

Please follow these instructions to prevent product failure and malfunction.

Location to place and surrounding environment

Do not place the cooker in any place exposed to direct sunlight, or spattering of oil or other liquids.

It may cause discoloration or deformation.

Keep the main body and its surrounding area clean.

Otherwise, dust or insects will enter the main body through its air inlet/outlet which maintains the function of the cooker, resulting in malfunction.

Do not place objects susceptible to magnets near the cooker.

The memory on objects such as cash cards, smart cards, etc. may be erased.

Noise may be generated on appliances such as TVs, radios and telephones.

Using the cooker

Do not use the following parts if there is foreign material or water drops.

Using the cooker with any foreign objects on the outer surface of the inner pot, the temperature sensor or the inner lid packing may result in poorly-cooked rice or cause malfunction.

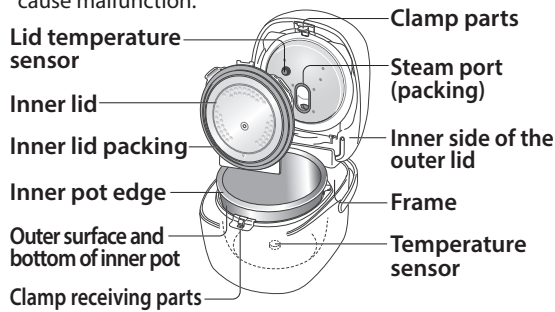

Do not cover the outer lid, especially the steam vent, with a dishcloth, towel, etc.

Steam may become trapped causing fogging of the display or deformation, discoloration or malfunction of the outer lid, steam vent or operation panel.

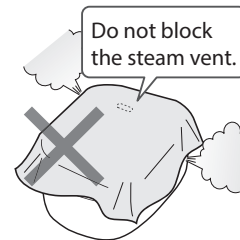

Do not use the cooker on an induction heating cooker.

It may cause malfunctions.

Regularly check the air inlet /outlet on the bottom of the main body, and remove any dust.

Stop using the product if it is dropped and a crack or rattling is found.

Contact the store from where the product was purchased in order to have it inspected or repaired.

Handling the inner pot

Do not put the inner pot on a gas cooking stove or induction heating cooker, or in a microwave oven or other similar appliance.

It may cause deformation or discoloration, resulting in malfunction.

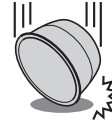

Do not drop the inner pot or hit it against hard objects.

Scratches and deformation to the inner pot may lead to improper cooking or malfunction of the cooker.

Do not damage the fluorine resin coating of the inner pot.

It may lead to peeling of the non-stick surface.

To avoid scratching or peeling-off of fluorine resin coating on the inner surface of the inner pot, do not use the inner pot in any of the ways below.

Avoid scratching and be careful with salt, acid and detergent.

- Do not put dishes in the inner pot and use it as a washing-up bowl.
- Do not use a scrubbing brush, or dishwasher/dryer for cleaning it.
- Do not use cleanser, bleach, etc. (Use neutral detergent for kitchen use.)
- Do not keep mixed rice and soup warm. (Clean the pot immediately after using seasonings.)
- Do not use vinegar.
- Do not hit or strongly scrape inner pot with spatula. Do not hit the cooker with sieve.
- Do not use a metal ladle, whisk, etc.



Scrubbing brush

Wire wool

Nylon brush

Do not use the polishing surface

Soft side of sponge



The surface of the fluorine resin coating may become uneven color with use. This does not affect the cooking, keep warm performance and hygienic quality. Also, fluorine resin is harmless even when ingested. You can use it without any problem.

Even when the coated outer surface of the inner pot is scratched, you can use the cooker to cook rice and keep it warm without any problems.

When using the inner pot for washing rice, place a cloth, etc. under the inner pot, so that the bottom of its outer surface will not be easily scratched.

Setting the clock to the current time

1 Plug in the power plug, and press  key for 2 seconds or longer.
Time on the display flashes.

2 Use   keys to change the time.
Hold down the key to change the time quickly in units of 10 minutes.

- The time is displayed using a 24 hour clock. (Midnight: 0:00/Noon: 12:00)

3 Press  key to complete the clock setting.
The clock display stops flashing.

- The clock cannot be set while cooking or keeping rice warm or when the timer is set.
- When setting the time, the following sound will be made.
 - ♪ 12 midnight ... a pattern of beeps
 - ♪ 12 noon the pattern of beeps is repeated twice

Names and handling of parts

Main body

Instructions for attaching and removing inner lid. (page 10)

- Wash the inner pot, inner lid, accessories before using the cooker for the first time. (pages 10 and 11)
- The cooker may have a smell of plastic, etc. at the first use but the smell will disappear with use. If concerned, try "Cleaning by boiling". (page 11)

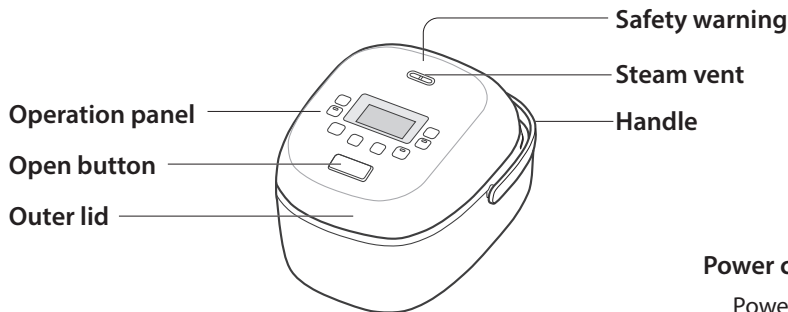
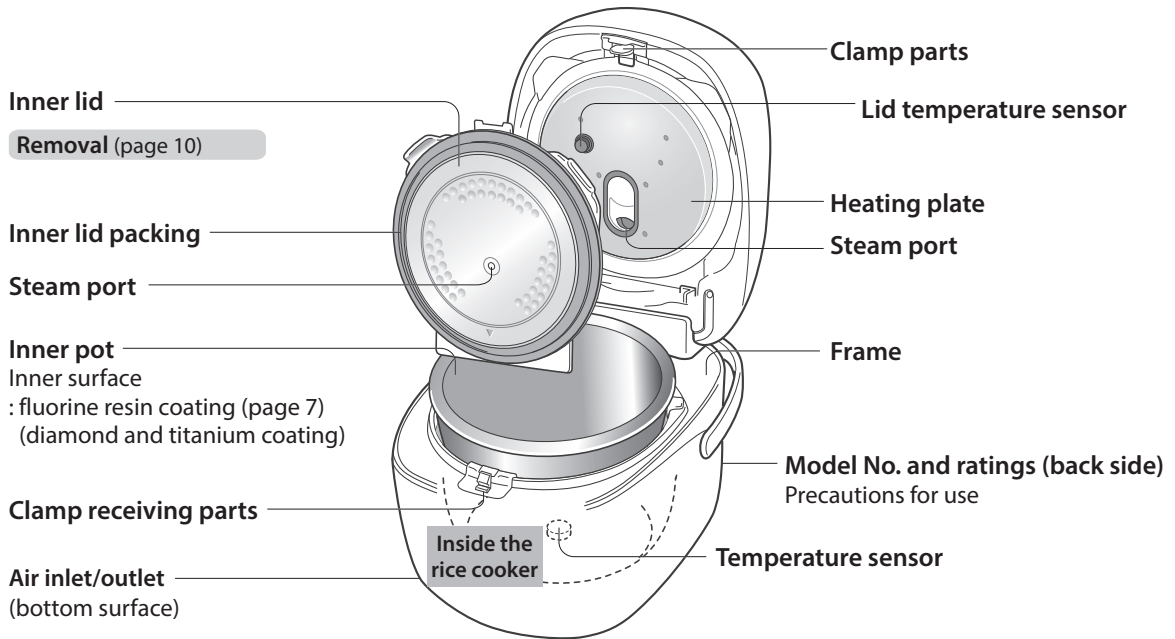

Power cord

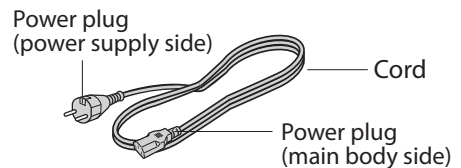

Power cord connection

- 1 Insert the power plug (main body side) into the plug insertion hole in the side of the main body.

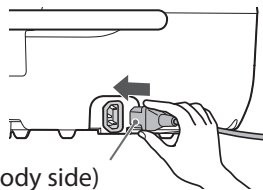

Power plug (main body side)

- ! Insert the power plug into the hole completely.

- 2 Insert the power plug (power supply side) into an electrical outlet.

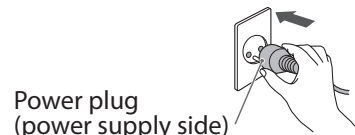

Power plug (power supply side)

Operation panel

- This is the factory default display.
- The protruded markings on the **START (开)** and **OFF (关)** keys are for persons who are visually impaired.

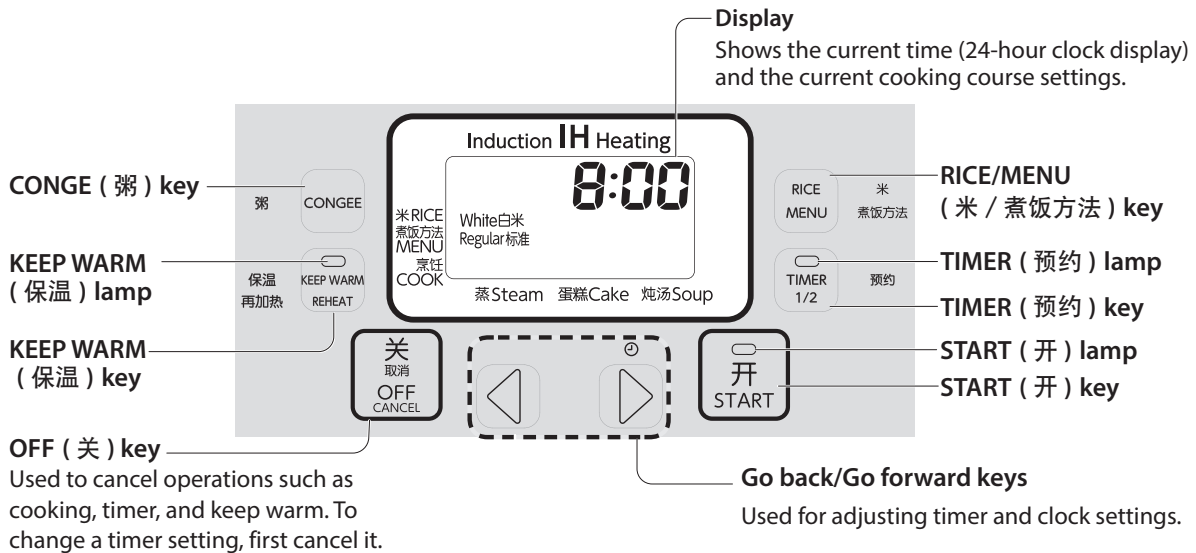

If you press the  key during use of the cooking, timer, or keep warm functions, the current time will be displayed only for as long as the key is held down.

Accessories

Material : Polypropylene (PP)



Measuring cup
(About 180 ml)



Rice scoop
Can be stood on its end.

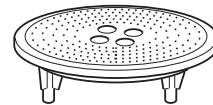

Steaming stand
Use only the included steaming stand.

Opening and closing the outer lid

Opening the outer lid

Press the open button.

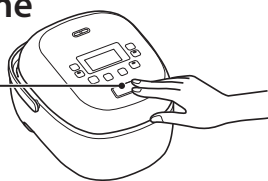

Closing the outer lid

Make sure there is no foreign matter in the clamp receiving parts or on the edge of the inner pot, and press the center front until it clicks.



- When the unit is warm, such as during keep warm operation, it may take longer to open or feel harder to close than when it is cold.
- The outer lid cannot be closed when the inner lid is not attached to prevent misuse without the inner lid.

Sounds made during usage

Buzzing	the sound of electrical conduction through induction heating (It sometimes makes sounds in the Keep Warm mode.)
Humming	the sound of the bottom fan rotating
Hissing	the sound of steam being ejected from the steam vent

Cleaning

! Before cleaning the cooker, unplug the power plug and wait until the cooker has cooled.
(Otherwise, you may get burned.)

Attention Please adhere to the following

● Do not clean with the following items

- Dishwasher / dryer
- Any other washing agent than neutral detergent for kitchen use
- Benzine, thinner, alcohol, cleanser or bleach
- Items that can easily cause scratching such as the abrasive surface of a nylon scrubber or melamine sponges (This may cause deformation, corrosion, discoloration, cracks and scratches)



● Always keep the cooker clean, free of foreign matter, seasonings, and moisture - Especially do not keep seasoned rice in the Keep Warm mode; clean it as soon as possible

(Causes odor and rust)

● Do not try to pull, push, or scratch the rubber packing.

The rubber packing of the main unit and inner lid cannot be removed (causes tearing of rubber packing)

Attaching and removing the inner lid

Removal Hold the tab with one hand, and while pushing up the inner lid lock button, pull the tab toward you.

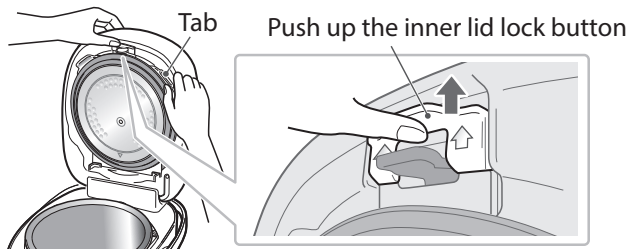

- Hold the tab with one hand to keep the inner lid from falling forward.

The outer lid cannot be closed when the inner lid is not attached to prevent misuse without the inner lid.

Attachment ① Place the insertion part behind the Projections.

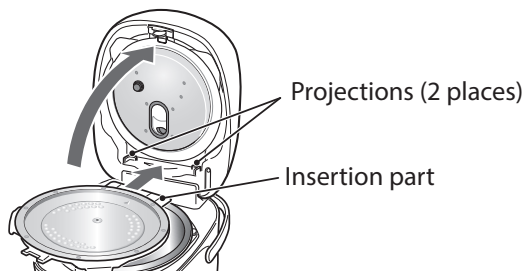

② Push the upper side of the inner lid until a clicking sound is heard.

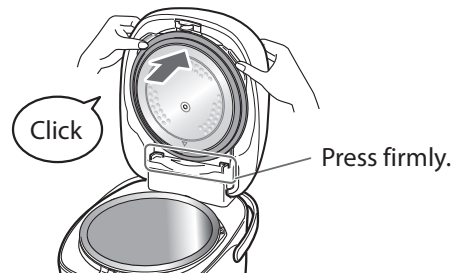

Wash with a soft sponge and mild kitchen detergent, then rinse well with water On each use

● Inner pot, inner lid, rice scoop, steaming stand and measuring cup

- Wash soon after the parts are cooled.
(Soak in lukewarm water before washing to help remove grime.)
- After cleaning, wipe dry with a clean, dry dishcloth.

Rusting can occur if there are any scratches and the parts remain uncleaned or moist.

Especially after cooking with seasonings, do not keep the rice warm. Wash the inner lid soon after cooking and wipe off the moisture.

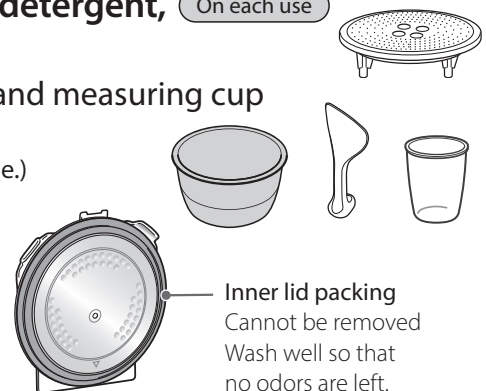

Wipe with a clean, soft, firmly-wrung cloth. (Each time used)

Do not immerse the cooker in water, pour water over it, or wash it with water.

● **Heating plate, Steam port**

Wipe away moisture (cause of odor)

● **Lid temperature sensor, Temperature sensor**

Wipe off grime and remove foreign material (cause of poor cooking)

If the dirt is stuck to the temperature sensor

Lightly rub with a fine abrasive paper and wipe off.

● **Rubber packing**

The parts are not detachable.

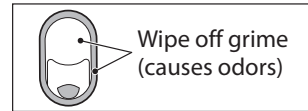

● **Inner side of the outer lid, frame**

Wipe off fluid on the frame or seasonings stuck to it. Remove foreign material

● **Clamp receiving parts**

If there are rice grains on the clamp receiving part, the lid may not close easily or it may not open.

The inner pot stopper rubbers
Cannot be removed (4 positions).

● **Inside the rice cooker**

● **Outer surface of the main body**

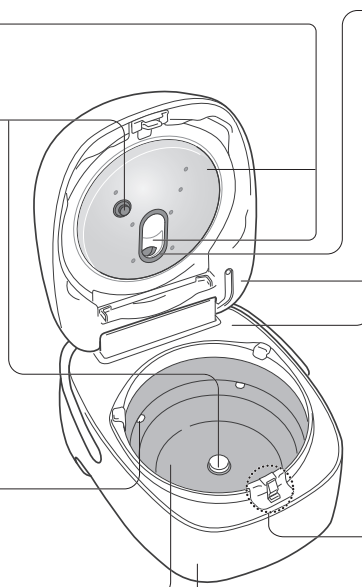

Cleaning with vacuum cleaner (Regularly)

● **Air inlet / outlet**

Remove dust and dirt about once a month (dust buildup may cause the operation to stop during cooking...page 31)

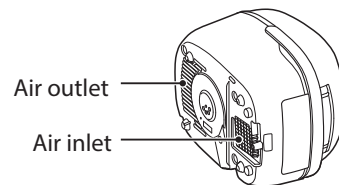

Cleaning by boiling (about once a week) Makes it easier to remove odors and stains.

1 Fill the inner pot with water up to the water level scale 1 for "白米 White rice" and close the lid

- Never add anything other than water (detergent, baking soda, etc.).

2 Select the <White 白米 / Quick 快煮> course and press  to start cleaning

- To change course, see Steps 3 - 6 on page 16.
- It takes about 40 minutes to reach the Keep Warm mode. (The actual time will be longer than the displayed time.)

3 When it enters the Keep Warm mode, press  and clean the parts after the unit has cooled down

- Do not continuously repeat cleaning by boiling.
- Some odors may not be completely removed.

Tips for cooking tasty rice



- **Use the freshest rice possible.**

Buy rice that has been recently milled, in quantities that can be used within two weeks to a month and store it in an airtight container in a cool, dark place.

Measure

- **Level off included measuring cup without shaking.**

If you shake the measuring cup, an excessive amount of rice will be put in the cup. There may be errors in measurement if a standard measuring cup for cooking (200 ml) is used.

The included measuring cup can be used for all types of rice.

[Good example]

[Bad example]

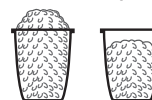

One level cup is about 180 ml.

Wash

- **Gently and quickly wash the rice with water so as not to damage it.**

(1) First, add plenty of water, stir the rice in water roughly and drain the water immediately. (Washing rice in hot water or slowly may cause rancidity.)

(2) Stir, rinse with water 4 to 5 times, and finally rinse 2 times.

(3) Adjust the water immediately. (Leaving the rice in a colander may cause the rice to break or become soggy.)

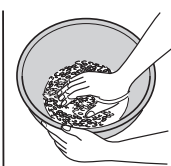

You can wash rice in the inner pot.

- **For prewashed rice (rice that has been processed so as not to require rinsing to be cooked), blend the rice with water.**

Stir from the bottom. If the water becomes cloudy, rinse once or twice.

(Otherwise, it may cause poor cooking outcome or scorching.)

Adjust water

- **Flatten the rice and adjust water on a level surface.**

Adjust the water to the water level scale according to the number of cups of rice to be cooked. (For water level scale for each course, see pages 14 and 15.)

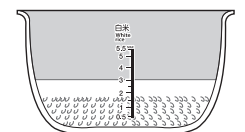

- **Adjust based on preference.** (! within 2 mm of the recommended water level scale)

Adjust the amount of water according to your preference and the condition of the rice. The condition of rice varies depending on the rice brand, place of origin, and storage conditions.

For harder rice	Put less water against the scale.	For freshly-harvested rice	Put less water against the scale.
For softer rice	Put more water against the scale.	For old rice, During the rainy season and in summer	Put more water against the scale.

- **Use water that is suitable for cooking rice (tap water or water from a water purifier).**

Water that is not appropriate for cooking



Mineral water with a hardness of 100 or higher

(It causes drying out or hardening of rice)



Alkaline ionized water with a pH9 or higher

(It causes a yellow discoloration or mushy rice.)

Water temperature of 30°C or less

Use cold water in summer.



Cold water is recommended when cooking rice with timer in hot weather.

(It causes poor cooking results or bad odor if the water temperature is high.)

Loosening the rice

- **Loosen rice immediately after it has been cooked.** (recommended within 10 min.)

While holding the inner pot with a dry cloth or mitten, cut the whole rice into four equal portions and turn them over one by one to loosen them.

This will prevent the rice clumping and being mushy.

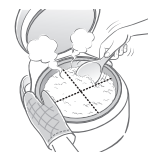

Sweet rice

Recipes for "Mixed rice with ingredients", "Sweet rice with red beans" (page 20)

- Since sweet rice alone is too soft, mix 2 cups of sweet rice with 1 cup of ordinary standard rice.
- When cooking sweet rice alone, use less water than the water level scale for "糯米饭 Sweet rice".

Congee

Do not use any course option other than Congee.
(may cause boiling over or burns)

- Use the <Congee 粥> course.
- Depending on the quality of the rice, water temperature, and washing method, a small amount of rice extract may come out of the steam vent.
- This is not a course for making congee from cooked rice.
- Seasonings should be added after the rice is cooked.

Partially milled rice

- Wash well if loose bran is abundant

White rice mixed with brown rice

(If cooking with brown rice and white rice mixed together.)

- Soak brown rice for 2 hours and cook it in "White 白米 / Sticky 软糯" with water adjusted to the "白米 White rice" level.

Rice with mixed grains

Mixed grains alone cannot be cooked.

(this may cause boiling over and burns)

- Follow the labeling on commercial grains for the amount to be mixed with rice (if not indicated, 1 tablespoon of grain for each cup of rice is recommended).
- Adjust the water to the water level scale, and then mix in the grain.

When mixing minor grains that float on water, soak only the minor grains separately from the rice for 2 to 3 hours beforehand. Once the minor grains no longer float, use them in cooking the rice.
(Floating grains may block the steam port, causing steam leaks, or the deformation or damage of the cooker.)

- If the grains do not sink into the water after soaking, cook with less rice, i.e., up to 2 cups for the 1.0L type and 4 cups for the 1.8L type.

When you add ingredients and seasonings — Important

Do not cook with <Quick 快煮>. Do not open lid to add ingredients while cooking.

Do not mix greens in from the start.

Boil the greens and add them after the rice is cooked. (A clogged steam port may cause burns.)

- **Observe the max. cooking volume.** (pages 14 and 15)
- **After washing the rice, soak the rice in water for about 30 minutes.**
Sweet rice takes about 1 hour, brown rice about 2 hours.
(Adding seasonings makes it harder for the rice to absorb water.)
- **After soaking, drain the rice in a colander.**
Do not let the rice sit after draining the water.
(If starchy material is deposited, it will burn easily.)
- **Add seasonings to congee only after it is cooked.** (Otherwise, a poor cooking outcome will occur.)
- **Add seasonings, adjust the water level to the scale, stir well from the bottom and flatten the rice.**
- **Then start the cooking immediately.** (If time elapses, the ingredients will settle at the bottom, causing poor cooking results.)
- **Ingredients** ...Cut into small pieces and place in a ring formation on top of the rice without mixing them with the rice. (Mixing with the rice may result in a poor cooking outcome.)
...The amount of ingredients should be up to 70 g per cup of rice. (up to 30 g of dried beans per cup)
- **Do not use the Keep Warm mode or the timer.** (It may cause discoloration, spoiling of the rice or corrosion of the inner pot or inner lid.)
- **Do not cook rice or keep it warm with vinegar added.** (Vinegar may cause discoloration and damage.)
- **Clean the inner lid as soon as possible.** (Otherwise, it may get rusty.)
If you use ingredients listed in commercially available recipes, or if you replace water with other liquid (e.g. tomato juice, etc.), the cooked rice may not turn out tasty.

Using different rice cooking courses

Be sure to select the correct course and fill to the correct water level scale for the rice you want to cook. (For Steam, Cake, and Soup courses, see page 22.)

Type of rice to cook	Situation	
White rice Prewashed rice	For standard cooking method	Use default settings. If it does not suit your preference, try the following courses.
	For especially tasty rice The <Delicious 美味模式> course is recommended at first, then later adjusting the setting according to your texture preference.	 <p>For grainier, harder rice</p> <p>Recommended texture with good balance of firmness and stickiness</p> <p>Sticky and fluffy rice</p>
	For quick cooking	Just quick (when forgetting to set timer)
	For rice seasoned and cooked with various ingredients (page 13)	Special courses for cooking rice with ingredients and seasonings. When adding ingredients and seasonings to congee or brown rice, use the respective cooking course.
	Cooking sweet rice (page 13)	
	For sushi rice	See page 21 for how to make Sushi rice. ⊘ Do not mix vinegar in the inner pot (may cause corrosion)
	For congee (page 13)	Special course that slowly heats and cooks the rice
Brown rice	Cooking brown rice	Making brown rice more tasty (To cook mixture of brown and white rice, see page 13.)
Mixed grain rice	Cooking white rice with mixed grains (page 13)	Cooking mixed grain or partially milled rice When adding mixed grains to congee or brown rice, use the respective cooking course.
Partially milled rice	For partially milled rice (page 13)	

- Estimated cooking time is based on 220V power input, room and water temperature of 23°C, and standard water level. The actual cooking time may vary by about 10 minutes depending on the amount of rice cooked, water temperature, and amount of water.
- If the "Timer" column is marked with "x", do not use the timer. If the "Keep Warm" column is marked with "☉", keep the rice warm for up to 24 hours; if it is marked with "○", keep it warm for up to 12 hours. "x" means do not use the Keep Warm function. (This may deteriorate or spoil the rice or corrode the inner pot or inner lid)
- To cook softer congee, use less rice or more water. However, do not add more water than the maximum water level scale for "粥 Congee".

Do not increase the amount of water too much.
(The allowable additional amount of water is up to 2 mm over the regular water level scale as a guide.)

Do not use any cooking courses other than those specified, such as <Quick 快煮>, when making congee, brown rice, or soup, which require more water.
(Use of other cooking courses may cause boiling over or burns. Use the <Congee 粥> course for congee.)

Using different rice cooking courses

	Course		Water level scale	1.0 L type		1.8 L type		Timer	Keep warm														
	Type of rice	Cooking course		Cooking volume (Rice quantity) Unit: Cups () indicates the max. cooking volume when adding ingredients	Approximate cooking time	Cooking volume (Rice quantity) Unit: Cups () indicates the max. cooking volume when adding ingredients	Approximate cooking time																
White 白米 Or Washed 免淘米*	Regular 标准	白米 White rice Or 免淘米* Pre-washed rice	0.5 to 5.5	60 to 70 minutes 3 cups take about 65 minutes	1 to 10	65 to 80 minutes 6 cups take about 70 minutes	○	◎															
									Hard 稍硬	40 to 50 minutes 3 cups take about 45 minutes	40 to 55 minutes 6 cups take about 50 minutes	○	◎										
														Delicious 美味模式	50 to 60 minutes 3 cups take about 55 minutes	55 to 65 minutes 6 cups take about 60 minutes	○	◎					
																			Sticky 软糯	55 to 65 minutes 3 cups take about 60 minutes	55 to 70 minutes 6 cups take about 65 minutes	○	◎
	Mixed 煲仔饭	糯米饭 Sweet rice	1* to 4*	40 to 50 minutes 3 cups take about 45 minutes	2* to 6*	45 to 60 minutes 4 cups take about 50 minutes	×	×															
			2 to 4	3 to 6	×	×																	
	Hard 稍硬	寿司饭 Sushi rice	1 to 5.5	40 to 50 minutes 3 cups take about 45 minutes	2 to 10	40 to 55 minutes 6 cups take about 50 minutes	○	◎															
Congee 粥									粥 Congee	0.5 to 1 (1)	95 to 105 minutes 1 cup take about 100 minutes	0.5 to 1.5 (1)	95 to 105 minutes 1 cup take about 100 minutes	○	×								
	Brown 糙米	Delicious 美味模式	糙米 Brown rice	1 to 4 (3)	100 to 110 minutes 3 cups take about 105 minutes	1 to 8 (6)	100 to 110 minutes 5 cups take about 105 minutes	○								○							
White 白米 Or Washed 免淘米*	Regular 标准	白米 White rice Or 免淘米* Pre-washed rice	0.5 to 3* (2)	60 to 70 minutes 3 cups take about 65 minutes	1 to 5* (4)	65 to 80 minutes 6 cups take about 70 minutes	×	○															
									White 白米	Regular 标准	白米 White rice	0.5 to 4* (3)	60 to 70 minutes 3 cups take about 65 minutes	1 to 8* (6)	65 to 80 minutes 6 cups take about 70 minutes	×	○						

★: The minimum and maximum rice-cooking volumes differ from the respective water level scales on the inner pot.
*: For the <Washed 免淘米> setting, the cooking time is approximately 5 minutes longer. (The displayed cooking time is also 5 minutes longer.)

For tips on cooking with each course or on adding ingredients and seasonings, please carefully read page 13.

Cooking rice

Start cooking after selecting type of rice and rice cooking course.

Preparation Inspect each part and remove any foreign material or water drops according to “Do not use the following parts if there is foreign material or water drops” on page 6.

1 After connecting the power cord, wash the rice, adjust the water level, place the inner pot into the main unit, and close the lid.

Wipe off any moisture from the outer surface of the inner pot. **!** Push the lid until it clicks.

2 Confirm rice cooking course settings.

- No change in Rice type selection → 5
- No change in cooking course → 7

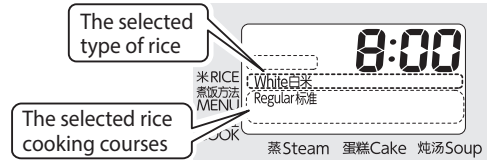

Example: Selection of <Washed 免淘米 / Delicious 美味模式

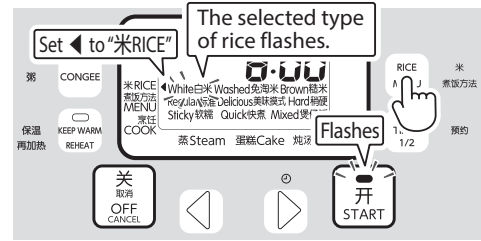

4 Press [Left] [Right] to select the type of rice.



- If you select <Brown 糙米>, you do not need to set the rice cooking course. → 7

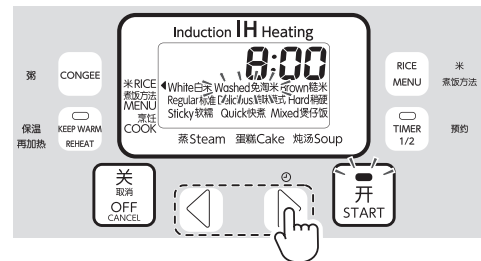

5 Press [RICE/MENU] until [Left] aligns with 煮饭方法 MENU.

The estimated cooking time for the selected rice cooking course will be displayed (in minutes).

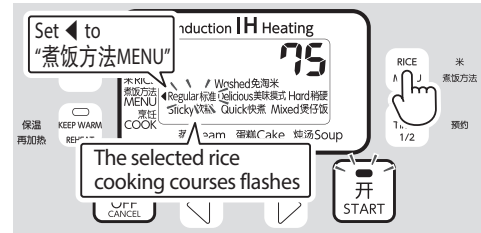

6 Press [Left] [Right] to select the rice cooking course.



- Press the RICE/MENU (米/煮饭方法) key again and the selected rice and cooking menu will start flashing, allowing you to confirm the cooking course. (This operation may be omitted.)

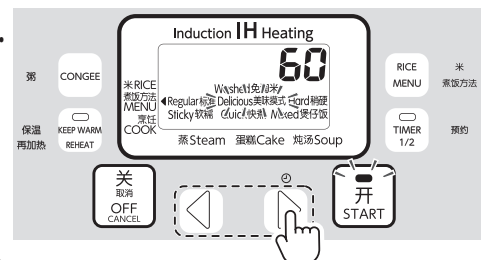

- 7 Press  to start cooking** ♪ 1 short beep
♪ 3 short beeps, 1 long beep
- If the inner pot is not set, the buzzer will sound and the cooking will not start.

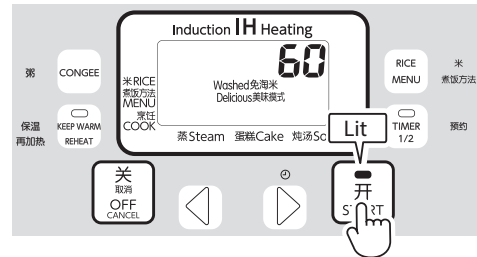

Cooking courses other than <Mixed 煲仔饭> are memorized, so there is no need to readjust the settings the next time you want to cook rice with the same course.

Time until cooking completion

The time until completion is displayed in increments of 5 minutes after the rice starts cooking, and then in increments of 1 minute after the steaming process begins. Please note that the time displayed may move forward or stop to adjust the time until the steaming process begins, so the time displayed is approximate.

Attention

If you want to cook rice again right after cancelling the Keep Warm mode, or just continue cooking a new batch, allow the inner lid and the inside of the chamber to cool down before cooking or setting the timer. (Otherwise, this may cause the rice to cook improperly or burn).

<Congee 粥> is selected using 

- 1 Press **
- <White 白米 / Congee 粥> will be selected. Press again and the selection will change to <Washed 免淘米 / Congee 粥>.

White 白米 Washed 免淘米
 Congee 粥 ←→ Congee 粥

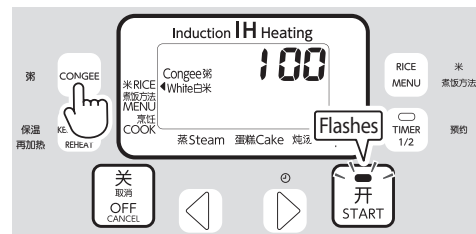

- 2 Press  to start cooking** ♪ 1 short beep
♪ 3 short beeps, 1 long beep

Setting the timer

The cooking will be completed at the set time. Two timer settings can be made, which are convenient for morning and evening meals.

Preparation Inspect each part and remove any foreign material or water drops according to "Do not use the following parts if there is foreign material or water drops" on page 6.

After connecting the power cord, wash the rice, adjust the water level, place the inner pot into the main unit, and close the lid.

1 Confirm the current time

- Setting the clock to the current time (page 7)

Example: Set "Timer 预约2" to 18:30

2 Press and select "Timer 预约1" or Timer 预约 2

Each time you press the Timer key, it will toggle between "Timer 预约1" and "Timer 预约 2".

- Cooking without changing completion time → 4

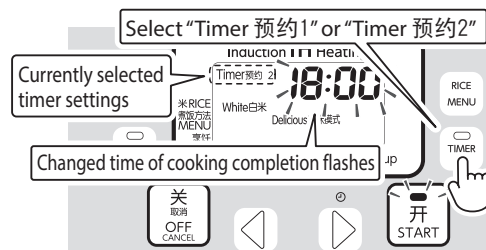

(The rice cooking lamp will flash.)

3 Press to set the cooking completion time.

The cooking completion time can be adjusted in 10-minute increments. Hold the key down to change the time quickly.

4 Check the rice cooking course.

- To change the course, see Steps 3 - 6 on page 16.

! When making congee, set to Congee.
(May cause boiling over or burns.)

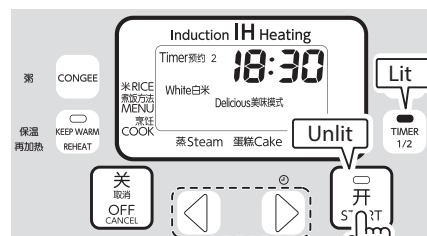

5 Press to complete the settings

- ♪ 1 short beep
- ♪ 1 long beep, 2 short beeps

Cooking may begin right away when timer is set for within 1 to 2 hours.

- After pressing the Timer key, if you have not pressed the Start key, the system will alert you with beeping sounds every 30 seconds.
- If the inner pot is not set, the buzzer will sound and the Timer settings will not be completed.

As the cooking completion time is stored in the memory, there is no need to readjust it the next time you use the same time setting.

To cancel the Timer or change the Timer settings, press the Cancel key.

First, cancel the Timer settings, reconfirm the currently selected cooking course, and redo the Timer operation.

Attention Please adhere to the following

- If the "Timer" column of the table on pages 14 and 15 is marked with "x", do not use the timer.
(Otherwise, it may deteriorate or spoil the rice or corrode the inner pot or inner lid.)
- Avoid setting the timer for longer than 14 hours (8 hours in summer).
(Long use of Timer may cause the rice to ferment and develop an odor.) It is recommended that cold water or ice water be used during the summer.

Notice

- If the rice is cooked slightly soft, reduce the amount of water as you like.
- In case of cooking with the timer set, the rice on the inner bottom surface of the inner pot may become light brown because the starch in the rice settles at the bottom of the pot. To avoid this, wash the rice well.
- The actual time for completing the cooking may be delayed by about 10 minutes when the room temperature or water temperature is low, or when the amount of water in the pot is increased.

Keep Warm mode

When the cooking is completed, the system will sound a buzzer and switch to the Keep Warm operation. You can restart the cancelled Keep Warm mode or reheat the rice being kept warm.

- The elapsed time for Keep Warm mode is displayed in 1-hour units.
- To keep the rice warm without spoiling its flavor, the cooker controls the keep-warm temperature depending on the operating conditions.
- When the inner pot is removed, the Keep Warm mode is automatically canceled.
- Unplug the power supply after use and clean the unit as soon as it cools down. (pages 10 and 11)

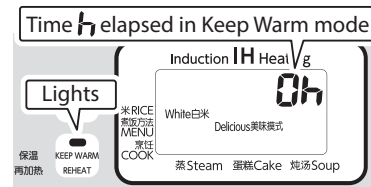

Reheating the rice being kept warm

1 Loosen the rice being kept warm, and close the outer lid.

- When there is too much rice, it may not warm up sufficiently. (As a guideline, keep the amount less than half of the inner pot)

2 Press to start reheating (for 9 minutes)

- To cancel Reheat operation midway, press  again to switch back to Keep Warm mode.

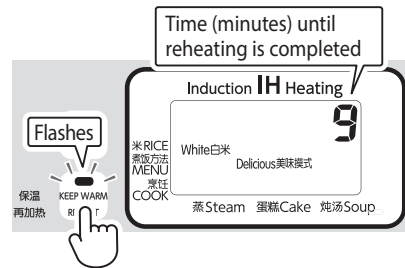

3 A buzzer will sound when completed. It will automatically switch to Keep Warm.

To restart the cancelled Keep Warm mode, press

- If the inner pot is not set, the buzzer will sound and the Keep Warm mode will not restart.

Attention — Pay attention to the following to prevent odors, drying, and discoloration

- **Stay within the Keep Warm time limits** If the "Keep warm" column of the table on pages 14 and 15 is marked with "◎", the rice can be kept warm for up to 24 hours; if "○", up to 12 hours; if "×", do not use Keep Warm mode.
 - After cooking rice with ingredients and seasonings, wash the inner pot and inner lid immediately without using the Keep Warm mode. (Otherwise, it may deteriorate or spoil the rice or corrode the inner pot or inner lid.)
 - Since mixed grain rice, brown rice, and partially milled rice are more prone to odor and discoloration than white rice, it is recommended that they be consumed or kept frozen as soon as possible.
 - If used in an area with extreme cold or heat and humidity, consume the rice as soon as possible.

When the elapsed time for Keep Warm flashes during Keep Warm operation, stop using Keep Warm.



- It flashes when the elapsed time is longer than the time it should be kept.
- It will continually flash after 25 hours. For <Brown 糙米> settings, it will continually flash after 13 hours.

- Do not leave a rice scoop in the inner pot.
- Do not use the Keep Warm mode for cold rice or reheat it.
- Do not leave rice in pot after cancelling Keep Warm mode.
- Take good care of the cooker and wash the rice thoroughly. If a bad odor occurs, clean the cooker by boiling. (page 11)

Notice

- If you are concerned about the rice being mushy, move it around and stir it occasionally so that no rice grains remain on the sides of the inner pot.
- Instead of keeping the rice warm for a long time or keeping a small volume of rice or mixed rice warm, it is recommended that it be stored in the freezer.
- The rice is more likely to turn yellow if it is not washed well, if there is not enough water when cooking, if the lid is opened and closed too often, or if the amount of rice is too small.

Recipes

- Use the measuring cup provided to measure the rice. (1 cup = about 180 ml)
- 1 tablespoon (tbsp) = 15 ml, 1 teaspoon (tsp) = 5 ml

Please also carefully read "When you add ingredients and seasonings". (page 13)

Mixed rice with ingredients

Mixed rice

Up to 4 cups for the 1.0 L type
Up to 6 cups for the 1.8 L type

Ingredients

(for four people)

White rice 3 cups
Carrot 60 g
Boiled bamboo shoots 60 g
2 dried shiitake mushrooms
Chicken breast 60 g
Fried tofu
..... 20 g (about 1/2 piece)
A Sake 1 tbsp
Salt 1 tsp
Soy sauce 1 tbsp
Japanese soup powder
..... 1/2 tsp
Water that the shiitake
mushrooms were soaked in

- 1 Wash the rice quickly until water becomes clear, and **soak it in plenty of water for 30 minutes.**
- 2 Reconstitute the dried shiitake mushrooms in water, and cut them into thin strips. Pour boiling water on the fried tofu and cut it into thin strips. Cut the carrot into thin strips, the boiled bamboo shoots into thin slices, and the chicken into small pieces.
- 3 **Drain the rice in a sieve basket,** and then put the rice in the inner pot. Add **A** to the inner pot, add water that the shiitake mushrooms were soaked in and fresh water up to **water level scale 3** for "White rice", and **mix well.**
- 4 **Place the cut ingredients on the rice in a ring shape** and close the outer lid.



- 5 Select the <White 白米 / Mixed 煲仔饭 > course and press the **START (开)** key.
- 6 When the rice is cooked, loosen all of the rice with a rice scoop.



Sweet rice with red beans (Cooked sweet rice)

Sweet rice

Up to 4 cups for the 1.0 L type
Up to 6 cups for the 1.8 L type

Ingredients (for four people)

The rice Sweet rice 2 cups
White rice (non-glutinous rice) 1 cup
Cow-peas (or red beans) 50 g

When using sweet rice only

Use less water.

- Wash quickly until the water is clear, then let rest in a sieve for approx. 30 minutes.
- Add the sweet rice and cooled cow-pea broth to the inner pot.
- For three cups, add enough water to water level scale 3 for "糯米饭 Sweet rice". Then remove approx. 60 ml of water and stir. (Remove approx. 20 ml of water for each cup of sweet rice.)

- 1 Put the cow-peas in cold water and bring it to the boil. Drain the water when it starts boiling. Add 600 ml of fresh water, bring it to a boil and then turn the heat to low. Simmer the cow-peas until they are 80 to 90% cooked. When the cow-peas are soft enough to be pressed flat between fingers, separate the peas from the broth and leave them to cool down.
- 2 Wash the rice quickly until water becomes clear, and **soak it in plenty of water for 1 hour.**
- 3 **Drain the rice in a sieve basket,** and then put the rice in the inner pot. Add the cooled pea broth to the pot to **water level scale 3** for "糯米饭 Sweet rice" and **mix well.**
- 4 **Place the boiled peas on the rice in a ring shape** and close the outer lid.



- 5 Select the <White 白米 / Mixed 煲仔饭 > course and press the **START (开)** key.
- 6 When the rice is cooked, loosen all of the rice with a rice scoop.

Sweet rice with red beans
(Steamed sweet rice)

➔ See page 23.

⚠ CAUTION

Make sure that the water level does not exceed the maximum water level scale of " 粥 Congee" when putting ingredients/seasonings/water in the pot.

(Putting too much in the pot may cause it to boil over, causing burns.)

Chicken congee

Congee

Up to 1 cup for the 1.0 L type
Up to 1.5 cups for the 1.8 L type

**Ingredients
(for four to five people)**

- White rice 1 cup
- Chicken breast ... 100 g
- 1 thumb of ginger
- 1 green onion
- Sake 1 tbsp
- Water 1000 ml
- Salt ½ tsp
- Mitsuba (honeywort)
..... as required

- 1** Wash the chicken well and place it in a pot with water, chopped green onion, grated ginger and sake. Bring the pot to a boil on a medium heat, and remove the scum on the surface to create broth. Pass it through a sieve and leave to cool.
- 2** Cut the chicken from step 1 into 1 cm cubes, and sprinkle them with salt.
- 3** Wash the rice quickly until water becomes clear and drain it in a sieve basket.
- 4** Put the rice from step 3 and the broth from step 1 in the inner pot, and add water up to **water level scale 1** for " 粥 Congee". Stir the mixture well.
- 5** Press the **CONGEE (粥)** key to set to <White 白米 / Congee 粥>, and press the **START (开)** key.



- 6** When the rice is done, add the chicken meat in step 2 and mix lightly.
- 7** Serve the food, and add mitsuba (honeywort - similar to flat leaf parsley) to decorate if desired.

Sushi rice

**Ingredients
(for four people)**

- White rice 3 cups
- Sweet vinegar dressing
(mix beforehand)
- Vinegar 6 tbsp
- Sugar 2 ½ tbsp
- Salt 1 ½ tsp

⊘ Do not mix vinegar in the inner pot. (It may cause corrosion.)

Cooking Notes

- If the sweet vinegar dressing is mixed when the rice is still hot, the rice can absorb the sweet vinegar dressing well.
- If you use a wooden sushi bowl, the bowl will absorb the excess moisture so the rice will not be mushy.
- If you use chilled seaweed stock instead of water, the taste will be enhanced.

- 1** Wash the rice quickly until water becomes clear, add water to **water level scale 3** for " 寿司饭 Sushi rice", and close the outer lid.
- 2** Select the <White 白米 / Hard 稍硬> course and press the **START (开)** key.
- 3** Wipe a wooden sushi bowl with a washcloth soaked in vinegar water, and move the cooked rice in the bowl.
- 4** Sprinkle the sweet vinegar dressing evenly onto the rice, and mix as though you are cutting the rice.



Fan the rice while mixing to make it glossier.



Cooking

(< 蒸 Steam>, < 蛋糕 Cake> and < 炖汤 Soup>)

Cooking courses that maintain a constant temperature.

< 蒸 Steam >...100°C
< 蛋糕 Cake >...115°C
< 炖汤 Soup >...90°C

⚠ WARNING

Do not use ingredients or do cooking not described on pages 23 to 27.

This may cause burns, injuries, or malfunctions from steam or food content spilling out. Also, the inner pot may rot or develop a bad odor.

Preparation Inspect each part and remove any foreign material or water drops according to “Do not use the following parts if there is foreign material or water drops” on page 6.

After connecting the power cord, place the inner pot containing the food to be cooked into the main unit, and close the lid.

Preparation for steaming

- Fill the inner pot with water up to the **water level scale 2** for “白米 White rice”.
- Place the steaming stand included in the package.

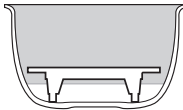

- Place the food to be steamed on the steaming stand and make sure the lid closes.

- Be sure that the food placed in the inner pot does not block the steam port in the center of the inner lid.
- Do not include plastic wrap, aluminum foil, cooking sheet, etc., as they tend to rise to the surface.

1 Press **RICE MENU** until **←** aligns with **烹饪 COOK**

The cooking time of the selected cooking course will be displayed (in minutes).

- Timer cannot be used.

Example: < 蛋糕 Cake > will be set at 35 minutes.



2 Press **←** **→** to select “Cooking courses”

蒸 Steam ←→ 蛋糕 Cake
↑ ↓
炖汤 Soup

- If no change to cooking time **→ 5**

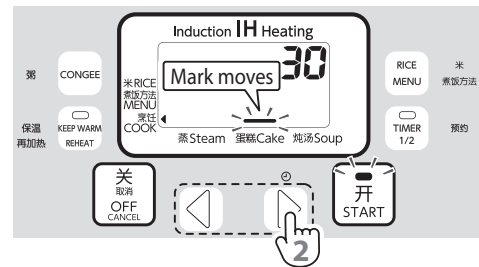

3 Press **RICE MENU** once again.

4 Press **←** **→** to change the cooking time.

The cooking time can be changed from 1 to 60 minutes in increments of 1 minute. Hold the key down to change in increments of 10 minutes.

- The cooking time begins from the time the cooking temperature is reached.

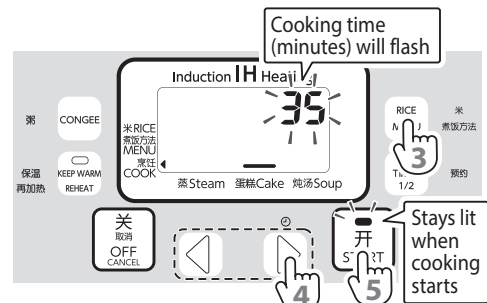

5 Press **START** to start cooking **♪** 1 short beep **♪** 3 short beeps, 1 long beep

- After the cooking temperature is reached, the time will decrease each minute, ending with a buzzer sound.
- If the inner pot is not set, the buzzer will sound and cooking will not start.

- When removing the inner pot, use a dry cloth or mittens. (Otherwise, it may cause burns.)

Attention

- **After cooking, do not leave food in pot and clean it as soon as possible.** (Otherwise, it may cause odors and rotting.)
- **Use plastic or wooden cooking utensils (to avoid damage to the inner pot).**

Notice

- The time settings for the recipes are approximate. The outcome may vary depending on the ingredients, room temperature, and other factors.

Steam < 蒸 Steam >

⚠ WARNING

Do not block the steam port in the inner lid with the ingredients in the inner pot.
(Otherwise, the cooker may boil over or you may get burned.)

Do not put plastic wrap, aluminum foil or oven sheets in the inner pot as they may easily float.
(Otherwise, the cooker may boil over or you may get burned.)

Sweet rice with red beans (Steamed sweet rice)

Max. cooking volume
Up to 2 cups

Ingredients

- Sweet rice 2 cups
- Cow-peas (or red beans) 30 g
- Water for sprinkling 80 ml
(40 ml per cup of rice)



- 1 Parboil the cow-peas (see step 1 in "Sweet rice with red beans (Cooked sweet rice)" on page 20). Separate the peas from the broth and leave them to cool.
- 2 Wash the rice quickly until water becomes clear, soak it in water with the pea broth added for 2 hours, and then place it in a sieve basket to drain the excessive water. Keep the water used to soak the rice for sprinkling.
- 3 Add water to the inner pot to **water level scale 2** for "白米 White rice", and place a steaming cloth on the steaming stand provided in the pot.

- 4 Mix the rice from step 2 and the peas from step 1. Place them on the steaming cloth so as to make a flat rice surface with several dents in it, and close the lid. Make sure that the steaming cloth does not stick out from the outer lid.

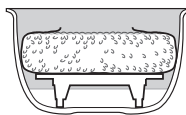

- ⊘ Do not block the steam port at the center of the inner lid with the steaming cloth.

- 5 Set the cooking course and cooking time (page 22), and press the **START (开)** key.

Cooking course	Cooking time
蒸 Steam	30 min.

- 6 When the buzzer sounds, sprinkle half of the water evenly onto the rice, mix the rice and close the outer lid.
- 7 Set the cooking course and cooking time (page 22), and press the **START (开)** key.

Cooking course	Cooking time
蒸 Steam	10 min.

- 8 When the buzzer sounds, sprinkle water once again and steam the rice again. (Repeat steps 6 and 7 again.)
- 9 When the buzzer sounds, move the cooked rice to another container and loosen it. If the cooked rice is hard, sprinkle more water, mix the rice, and steam it for about 10 minutes.

Cooking (<蒸 Steam>, <蛋糕 Cake> and <炖汤 Soup>)

Steam <蒸 Steam>

Steamed gyoza (potstickers)

Max. cooking volume
The amount in the recipe (10 pieces)

Ingredients (for 10 pieces)

Minced pork 70 g
 A { 1/3 of a green onion
 Garlic chives 1 stalk
 Garlic ... 1/3 of a clove
 Ginger ... 1/3 of a thumb
 A pinch of salt
 Soy sauce 2/3 tsp
 Sake 2/3 tsp
 Sesame oil 2/3 tsp
 10 dumpling wrappers
 For the seasoned agar jelly
 B { Powdered agar 1 g
 Water 80 ml
 Chinese soup powder
 1/3 tsp
 A few cabbage or napa cabbage
 leaves

- 1** Make the seasoned agar jelly. Put the ingredients in **B** in a pot and bring to the boil while stirring constantly for 2 minutes until dissolved. Transfer into a container to solidify. When the jelly has solidified, tear it into small pieces.
- 2** Finely chop the green onion, garlic chives, garlic and ginger.
- 3** Put the mince, the jelly from step 1, and the ingredients in **A** into a bowl. Mix the contents well until a paste state is formed, and divide the mixture into 10.
- 4** Place the mixture from 3 onto a dumpling wrapper, and seal the edges of the wrapper firmly.
- 5** Add water for steaming in the pot up to **water level scale 2** for "白米 White rice", place the **steaming stand provided** in the pot, and cover it with cabbage or napa cabbage.



- 6** Place the gyoza from step 4 on the steaming stand.
- 7** Set the cooking course and cooking time (page 22), and press the **START (开)** key.

Cooking course	Cooking time
蒸 Steam	15 min.

Shumai (pork dumplings)

Max. cooking volume
The amount in the recipe (10 pieces)

Ingredients (for 10 pieces)

Minced pork 100 g
 A { Peeled shrimp ... 50 g
1/4 of a green onion
 Ginger juice 1 tsp
 Soy sauce 2/3 tsp
 Sugar 1 tsp
 Sesame oil 1 tsp
 Salt 1/3 tsp
 Potato starch 2 tsp
 A small amount of
 pepper
 10 shumai wrappers
 10 green peas
 A few cabbage or napa cabbage
 leaves

- 1** Finely chop the peeled shrimp and green onion.
- 2** Put the mince and the ingredients in **A** in a bowl, and mix well until a paste state is formed. Divide the mixture into 10.
- 3** Make a circle with the fingers of your left hand and place a shumai wrapper on top. Place the mixture from step 2 on the wrapper and push it down using a knife or spatula so as to form a cylinder. Stick the end of the wrapper to the filling, and decorate with a green pea.
- 4** Add water for steaming into the pot up to **water level scale 2** for "白米 White rice", place the **steaming stand provided** in the pot, and cover it with cabbage or napa cabbage.



- 5** Place the shumai from step 3 on the steaming stand.
- 6** Set the cooking course and cooking time (page 22), and press the **START (开)** key.

Cooking course	Cooking time
蒸 Steam	15 min.

Cake <蛋糕 Cake>

Dome sponge cake

Max. cooking volume
Wheat flour - Up to 120 g

- Ingredients**
- Wheat flour 120 g
 - Baking powder 1/2 tsp
 - 4 eggs
 - Granulated sugar 100 g
 - A few drops of vanilla essence
 - Melted butter 30 g
 - A dab of butter to grease the pot
 - Milk 30 ml
 - Apricot jam (pureed) ... 4 tbsp (80 g)
 - For the icing
 - A** Powder sugar 50 g
 - Lemon juice 1 1/2 tsp



1 Mix and sift the wheat flour and baking powder. Grease the inner pot lightly with melted butter.

2 Crack the eggs in a dry bowl and add the granulated sugar. Mix the eggs and the sugar lightly with a whisk, then immerse the bowl in hot water. When the egg mixture has warmed up to body temperature (about 40°C), take the bowl out of the hot water and whisk. Do not beat it in the inner pot.



3 Beat the mixture well with the whisk until it becomes white and thick, and add 2 or 3 drops of vanilla essence.



4 Sift the flour mixture from step 1 into the egg mixture from step 3 gradually, in two or three times. Mix it quickly with a wooden spatula so that the foam bubbles may not be broken until the mixture is well mixed.



5 Sprinkle the melted butter and the milk on the mixture from step 4, and mix it quickly so that the foam bubbles may not be broken.



6 Pour the mixture from step 5 into the inner pot, and pat the pot once or twice to break the larger air bubbles. Put the inner pot in the cooker and close the outer lid.

7 Set the cooking course and cooking time (page 22), and press the **START (开)** key.

Cooking course	Cooking time
蛋糕 Cake	30 min.

8 When the buzzer sounds, put a bamboo skewer into the cake to check that it is cooked through. If the skewer comes out clean the cake is cooked. If you find some dough on it, add some more time to cook the cake.

9 Use a mitten, etc. to remove the inner pot and place the cake on a dish, etc. to cool.

10 Apply apricot jam to the surface of the cake with a brush. Mix the ingredients in **A** to make icing, and put the icing on the cooled cake. Then let the icing dry.

Cooking Notes

- Before beating, wipe off any grease or water from the bowl and whisk.
- You can use an electric mixer for easy beating. (Do not use it inside the inner pot.)
- The top of the cake will not turn brown. Turn the cake upside down before decorating.
- If the icing is too hard or soft, adjust the amount of lemon juice and powder sugar.
- You can decorate the cake with whipped cream and/or cut fruit instead of icing.

Cooking (<蒸 Steam>,<蛋糕 Cake> and <炖汤 Soup>)

Cake <蛋糕 Cake>

Pineapple coconut cake

Max. cooking volume
Wheat flour - Up to 100 g

Ingredients

- Wheat flour 100 g
- Coconut flour 2 tbsp
- A** Baking powder 1 1/2 tsp
- Granulated sugar 80 g
- A pinch of salt
- Milk 70 ml
- 2 small eggs (100 g)
- Cooking oil 2 tbsp
- A few drops of vanilla oil
- Pineapple in syrup
(canned pineapple slices) 75 g
- Finely shredded coconut 15 g
- For the topping
 - Apricot jam 1 tbsp
 - Rum 2 tsp
 - Finely shredded coconut ... 5 g
 - Pineapple in syrup
(canned pineapple slices)... 2 slices
- Melted butter for greasing the pot



- 1** Wipe excess syrup from the pineapple. Chop the slices for the cake mixture into 5 mm cubes, and cut the two slices for the topping into 8 even pieces.
- 2** Mix the dry ingredients in **A** and sift into a bowl. Add the milk, eggs and cooking oil in this order. Mix them with a whisk, then add the vanilla oil, chopped pineapple for the cake mixture and finely shredded coconut, and mix well.
- 3** Grease the inner pot with melted butter and pour in the mixture from step 2.
- 4** Set the cooking course and cooking time (page 22), and press the **START** (开) key.
- 5** When the buzzer sounds, put a bamboo skewer into the cake to check that it is cooked through. If the skewer comes out clean the cake is cooked. If you find some dough on it, add some more time to cook the cake.
- 6** Use a mitten, etc. to remove the inner pot and place the cake on a dish, etc.
- 7** Spread the apricot jam and rum mixture onto the cake while it is hot. Decorate with pineapple, and sprinkle shredded coconuts for topping.
This moist cake is made simply by mixing the ingredients together.

Cooking course	Cooking time
蛋糕 Cake	35 min.

Soup <炖汤 Soup>

! WARNING

Do not put the following things in the pot.
(It may boil over and cause burns.)

- Fish pastes, beans, noodles, baking soda, roux (e.g. curry roux, stew roux), large amounts of oil, ingredients such as milk that will bubble up easily.
- Things that float easily to the surface such as greens, plastic wrap, aluminum foil, oven sheets and scum removing sheets.

! CAUTION

Make sure that the water level does not exceed the "炖汤 Soup MAX" level scale when putting ingredients/seasonings/water in the pot.
(Putting too much in the pot may cause it to boil over, causing burns.)

Attention

- In the <炖汤 Soup> course, the heating power is reduced after boiling, so add ingredients from the beginning. (Excluding greens and ingredients that cook fast.)

White radish and pork spare rib soup

Maximum volume
- up to the 炖汤 Soup MAX level scale

Ingredients

Pork spare ribs 80 g
 White radish 160 g
 Half an onion
 Water 500 ml

A [Salt as required
 A pinch of MSG
 A small amount of
 sesame oil

- 1 Cut the spare ribs into 3 cm wide pieces. Slice the white radish thinly, and finely chop the onion.
- 2 Put the ingredients from step 1 in the pot, pour in 500 ml of water and close the lid.
- 3 Set the cooking course and cooking time (page 22), and press the **START** (开) key.

- 4 When the buzzer sounds, skim off any floating oil, and add the ingredients in **A**.
If the ingredients are not fully cooked, increase the cooking time.

Cooking course	Cooking time
炖汤 Soup	60 min.

White radish, corn and pork backbone meat soup

Maximum volume
- up to the 炖汤 Soup MAX level scale

Ingredients

Pork backbone
 (chine) 120 g
 White radish 60 g
 Carrot 30 g
 Ear of corn 30 g
 Ginger as required
 Water 500 ml

A [Salt as required
 A pinch of MSG
 A few drops of vinegar...optional

- 1 Cut the backbone into 1.5 cm cubes, and cut the ear of corn into 3 cm pieces. Cut the white radish and carrot into cubes, and grate the ginger.
- 2 Put the ingredients from step 1 in the pot, pour in 500 ml of water and close the lid.
- 3 Set the cooking course and cooking time (page 22), and press the **START** (开) key.

- 4 When the buzzer sounds, skim off any floating oil, and add the ingredients in **A**.
If the ingredients are not fully cooked, increase the cooking time.
After serving, add vinegar to your liking.
(Do not pour vinegar in the inner pot.)

Cooking course	Cooking time
炖汤 Soup	60 min.

Troubleshooting

Please check the cause of the problem before requesting for a repair.
If you cannot find the cause, contact the shop from which the product was purchased.

Problem		Causes / what to check (reference page)
<ul style="list-style-type: none"> ● Did you measure the rice and water accurately? (page 12) ● The texture of rice varies depending on the type, brand, storage period, etc., of the rice. Adjust to your preferences by testing out different amounts of water and other courses. 		
Rice	...is soft ...is mushy ...clumps ...is not tasty	<ul style="list-style-type: none"> • Reduce the amount of water, or use the <Hard 稍硬 > course. • Loosen the rice immediately after it is cooked. • For recently harvested rice, cook it with a little less water. • Rice becomes softer when it is soaked before cooking or the timer is set for cooking. • Washing rice too hard or leaving it in a sieve basket for a long time will cause rice grains to crack and/or break, resulting in mushy rice. • Did you use hot water or alkaline ionized water with a pH of 9 or higher? (page 12)
	...is hard ...dries out ...is not tasty	<ul style="list-style-type: none"> • Increase the amount of water, or use the <Sticky 软糯 > course. • Soak rice in water before cooking. • Did you use hard mineral water ? (page 12)
	...scorches Rice becoming golden brown is not a malfunction.	<p>In the following cases, the rice may easily be scorched.</p> <ul style="list-style-type: none"> • When rice is not washed sufficiently. • When rice is soaked for a long time; or When rice is cooked using the timer. • When pre-washed rice is cooked, wash rice 1 or 2 times before cooking to prevent scorching. • When cooking whole rice, or adding seasonings to cook mixed rice. • When foreign objects are attached on the temperature sensor, lid temperature sensor, etc.
	...does not cook well ...is not tasty	<ul style="list-style-type: none"> • Did you start cooking while the inside of the cooker or inner lid was hot ? Start cooking after cooling it down. • Rice cooked in the <Quick 快煮> course may be slightly mushy or hard. Try cooking rice using the <Delicious 美味模式> course. (pages 14 and 15) • Are any foreign objects stuck in the inner lid? Are any foreign objects stuck on the lid temperature sensor, temperature sensor, inner lid packing, inner pot rim or air inlet/outlet? (pages 10 and 11.) • Has the inner pot or inner lid been deformed, or did you forget to attach the inner lid ? • Was there a power failure while cooking ?
	Mixed rice does not cook well	<ul style="list-style-type: none"> • Did you mix ingredients into the rice ? • For other reasons, see "When you add ingredients and seasonings". (page 13)
Rice kept warm...	...smells bad If the rice smells, be sure to clean the cooker by boiling before use. (pages 10 and 11)	<ul style="list-style-type: none"> • Did you do any of the following ? Using the Keep Warm mode for too long, using it for mixed rice, using it for cold rice, leaving the rice scoop in the pot, or using the Keep Warm mode repeatedly for long periods of time. • Rice with mixed grains or partially milled rice can be kept warm. However, It is recommended to eat it as soon as possible or store it in the freezer because keeping it warm could easily cause bad odors or discoloration. • Are the inner lid and/or the main body dirty ? Be sure to remove the inner lid, clean and dry it with a clean cloth every time you cook. Also wipe off water droplets in the steam port every time. (pages 10 and 11) • Did you wash the rice sufficiently ? Did you set the timer for too long ? (pages 12 and 18) • Is the rice still in the pot with the Keep Warm mode off ? During the Keep Warm mode, did you remove the inner pot and then put it back; did you press the OFF (关) key accidentally; or was the cooker forced off due to a power failure for a long duration of time ?
	...is not hot enough	<ul style="list-style-type: none"> • Reheat the rice before serving. (page 19)

Problem		Causes / what to check (reference page)
Rice kept warm...	...is mushy	<ul style="list-style-type: none"> Use the Keep Warm mode after cooking rice with a little less water. Loosen the rice immediately after it is cooked. Gather the rice stuck to the side surface of the inner pot and loosen the rice occasionally.
	...dries out ...becomes discolored	<ul style="list-style-type: none"> Are there any foreign objects on the inner lid packing, inner pot rim, or main body frame ? Are there any foreign objects on the outer side of the inner pot or the temperature sensor ? Did you use the Keep Warm mode for a long time or repeatedly reheat the rice ?
Opening / closing the outer lid	The outer lid is hard to close. The outer lid does not close.	<ul style="list-style-type: none"> Is the inner lid in place ? The outer lid cannot be closed when the inner lid is not attached to prevent misuse without the inner lid. Are the insertion parts of the inner lid properly fitted in place ? (page 10) Are there any foreign objects on the clamp receiving parts or clamp parts ? (page 11) Are any foreign objects stuck in the inner lid ? (page 10)
	The outer lid opens during cooking.	<ul style="list-style-type: none"> Push the center of the outer lid front part until it clicks. Are there any foreign objects on the clamp receiving parts or clamp parts ? (page 11)
Timer setting	Cooking starts immediately after setting the timer. Cooking does not finish at the preset time. The timer cannot be set.	<ul style="list-style-type: none"> For a timer setting within after an hour or two, cooking starts on the spot. Did you misread the clock ? The cooker uses a 24-hour clock. Is the current time correct ? Has the lithium battery burnt out ? (page 31) The actual time for finishing the cooking may be delayed by about 10minutes when the room temperature or water temperature is low, or when the amount of water in the pot is increased. When you set the timer, was the inner pot in place? Did you forget to set the timer or press the START (开) key at the end?
Cooking / keeping warm	Steam leaks out of the cooker Check the reason after cooking is finished.	<ul style="list-style-type: none"> Are there any foreign objects on the inner lid packing, inner pot rim or frame ? (pages 10 and 11) Are there any foreign objects on the inner lid, clamp receiving parts or clamp parts ?(pages 10 and 11) Has the inner lid packing been damaged, or has the inner lid or inner pot become deformed ? Is the inner lid properly fitted ? (page 10)
	There are water droplets near the steam vent	<ul style="list-style-type: none"> Water droplets may form when the steam cools. This is not a problem.
	There are water droplets on the inner lid or inner pot.	<ul style="list-style-type: none"> Water droplets may form on the inner lid or inner pot to prevent the rice from drying out. This is not a problem.
	When the outer lid is opened, water drips from the packing, etc.	<ul style="list-style-type: none"> Water may drip onto the frame, etc., depending on the timing of opening the outer lid, the room temperature, and so on. Wipe it off. When the lid is not opened completely, or opened slowly, condensation on the inner lid may fall on the inner pot (rice) instead of the outer frame. If the power or Keep Warm setting is turned off while rice is in the pot, a large amount of condensation will accumulate on the lid. Are there any foreign objects on the temperature sensors or the outer surface of the inner pot ?
	The cooker... ...boils over ...spatters	<ul style="list-style-type: none"> Was the amount of rice too small ? Was the water too much ? Did you wash the rice sufficiently ? Was a correct course used when cooking congee? (pages 14 and 15) Are foreign objects attached to the temperature sensor or the lid temperature sensor ? Have you attached the inner lid ? Are any foreign objects stuck in the inner lid ? (page 10)
	A thin film is formed on the inner pot.	<ul style="list-style-type: none"> Thin films like wafer paper are dried starch in the rice. This is not a problem.
	The center of the rice has hollowed out.	<ul style="list-style-type: none"> This is caused by the inner pot heating itself in the unique IH cooking system. This is not a problem. Loosen all of the rice.

Troubleshooting (continued)

Before requesting for repair, please check the following.

Problem	Causes / what to check (reference page)
Cooking	Cooking takes a longer time. The displayed time does not change. <ul style="list-style-type: none"> The preset clock will start changing when the temperature for cooking is reached. The actual time period required to finish cooking will be longer as it includes the time during which the temperature increases to the target temperature.
	The cooked food does not turn out tasty. <ul style="list-style-type: none"> Doneness varies depending on the kinds of ingredients and how they have been measured. Check the recipe or change the setting time. In the following cases, the cooked food may not turn out tasty. The outer lid is not fully closed; steam is leaking (page 29); foreign objects are attached to the temperature sensor or the lid temperature sensor; the inner pot is deformed; cooked rice was left in the pot; or there was a power failure while cooking (page 31).
	The timer cannot be set. <ul style="list-style-type: none"> The timer cannot be set for < 蒸 Steam>, < 蛋糕 Cake> and < 炖汤 Soup> courses.
Display / keys	Key operation is not possible. <ul style="list-style-type: none"> Is the power plug connected? Is the inner pot in place? Is an error message, e.g. "C ○○", "F ○○", etc. being displayed? (page 31)
	The lamps went off. Cooking has stopped halfway. <ul style="list-style-type: none"> If you remove the inner pot during use, power will be cut off. If you press the OFF (关) key accidentally, or there is a long-time power failure, the power will be cut off.
	Display of remaining time is different from the actual cooking time. <ul style="list-style-type: none"> The actual cooking time may differ from the displayed time. This is not a malfunction. See "Time until cooking completion" on page 17 for details.
	Want to set the current time. <ul style="list-style-type: none"> See "Setting the clock to the current time" on page 7.
	The elapsed time displayed in the Keep Warm mode is flashing. <ul style="list-style-type: none"> This is to notify you that rice is being kept in the Keep Warm mode for too long. Stop the Keep Warm mode. (page 19)
	Buzzer sounds and (C○ ○ or F○ ○) is displayed. <ul style="list-style-type: none"> See "Error display" on page 31.
	The display disappears. The time display 0:00 is flashing. <ul style="list-style-type: none"> The lithium battery embedded in the main body has run out. (page 31)
	The display is fogged. <ul style="list-style-type: none"> Wipe off all moisture from the outer surface of the inner pot and the inner lid. The display may become fogged during cooking and for a while after entering the Keep Warm mode due to the difference in temperature between the inside of the cooker and the surrounding environment, but this will disappear with use.
Other problems	The cooker makes noises while in use. Turning off or changing the sound <ul style="list-style-type: none"> See "Sounds made during usage" on page 9. It is not possible to turn off or change volume of buzzer sounds and operating sounds.
	There is a smell of plastic, etc. <ul style="list-style-type: none"> The cooker may smell at first, but the smell will decrease with use. If you are worried about the smell, ventilate the room or clean the cooker by boiling. (page 11)
	Plastic parts have line marks or wavy portions. <ul style="list-style-type: none"> These come from plastic molding and they are not abnormal. You can use the cooker to cook rice and keep it warm without any problems.
	There is a gap between the outer lid and the main body. <ul style="list-style-type: none"> There is the gap between the outer lid and the main body but it is sealed with the inner lid packing.
	The coating on the outer surface of the inner pot is scratched or dirty. <ul style="list-style-type: none"> The coated outer surface of the inner pot may become scratched or dirty with use. You can use the cooker to cook rice and keep it warm without any problems.
	Sparks come out of the power plug. <ul style="list-style-type: none"> Small sparks are sometimes generated when plugging or unplugging the power plug. This is inherent to the IH (induction heating) method and is not a malfunction.
	The circuit breaker is tripped during cooking. <ul style="list-style-type: none"> If you use the cooker together with other electrical appliances at the same time, electricity use may exceed the rating and trip the breaker. Do not share the electrical outlet used for the cooker with other appliances.

Error display

If "C 00" is displayed, check the cause of the problem again.

Unplug the power plug (power supply side) from an electrical outlet, and take the following suited action(s).

C 10	<ul style="list-style-type: none"> Remove dust from the air inlet / outlet at the bottom part of the main body. Do not use the rice cooker on a soft surface such as paper, cloth, carpet, plastic bags etc., or in a place where the air inlet /outlet is blocked. 	<p style="text-align: center;">Resetting the display</p> <p>After taking the recommended action(s), plug in the power plug, and press  key.</p> <p>(Error display is reset.)</p> <p style="text-align: center;">↓</p> <p>Resume the operation after cooling down the inside of the body, inner pot and inner lid.</p>
C 11	<ul style="list-style-type: none"> Remove foreign objects such as rice grains adhered to the outer bottom part of the inner pot and the temperature sensor. Has too much water been added? (Reduce the amount of water) Are you using the same electrical outlet with other appliances? → Use a 220 V AC outlet with a rating of 10 A or more. Do not share the outlet with other appliances. 	
C 14	<ul style="list-style-type: none"> This error alerts you to prevent damage to some parts when high voltage is applied. 	
C 15	<ul style="list-style-type: none"> Are you using an inner pot other than the specified one? → Use the specified inner pot. 	
C 16	<ul style="list-style-type: none"> Did you take out the inner pot after setting the timer or while cooking? 	

F 01 to F 14	<p>When "F13" is displayed, the START (开) and KEEP WARM (保温) lamps flash and the buzzer sounds continuously.</p> <ul style="list-style-type: none"> These displays indicate the malfunctioning of the printed circuit boards, temperature sensors, etc. Immediately stop using the cooker, unplug the power plug, and contact the shop from which the product was purchased.
-------------------------	---

Contact the store from which the product was purchased in the following cases.

- When you put rice or water directly into the cooker instead of the inner pot.
- When you have damaged or lost the inner pot, inner lid or power cord.
- When any plastic parts or rubber packings become damaged. (They may become damaged after several years of use.)

When a power failure occurs

After recovering from a power failure, the cooker will resume cooking rice or keeping it warm.

However, the cooked rice may not be tasty, the power may be cut off, or the preset finishing time may be delayed. This also applies when you unplug the power plug or the circuit breaker is tripped.

Lithium battery

The lithium battery embedded in the main body is used to work the clock and memorize cooking courses when the power plug is unplugged.

If the lithium battery is exhausted

When the power plug is unplugged, the display will disappear, and the timer settings and memorized cooking courses will be cleared.

To use the rice cooker, plug it in, and press the OFF (关) key to stop the 0:00 display from flashing. The cooker can then be used normally.
(Be sure to set the current time before using the timer.)

➔ **To replace the battery, contact the store from which the product was purchased. (Cost borne by user.)**

The lithium battery is embedded in the main body. Do not disassemble the main body. You cannot replace it by yourself.

Specifications

Model No.	RC-DR10T	RC-DR18T	Model No.	RC-DR10T	RC-DR18T	
Type	Rice cooker with keep-warm function		Outer Dimensions	Width	26.4 cm	29.5 cm
Power supply	220 V AC, 50 - 60 Hz			Depth	32.7 cm	35.6 cm
Rated power consumption (Cook)	1100 W	1250 W		Height	23.2 cm	27.2 cm
Rated power consumption (Keep Warm)	Average 38 W*	Average 47 W*	Mass	4.4 kg	5.5 kg	
			Length of cord	1.2 m	1.2 m	

* Average power consumption per hour in the Keep Warm mode.

(Conditions: maximum amount of rice; at a room temperature of 23°C; and with application of 220V.)

- See pages 14 to 15 for cooking capacity.
- See the pages listed below and page 22 for information on the < 蒸 Steam>, < 蛋糕 Cake>, and < 炖汤 Soup> courses.
 - < 蒸 Steam> : pages 23 and 24
 - < 蛋糕 Cake> : pages 25 and 26
 - < 炖汤 Soup>: page 27
- This product is not intended to be used at altitudes of over 2000 m.

Warranty (Attachment)

- A warranty is attached to this product.
- Read the warranty well and keep it in a safe place.

Repair service

Please contact the store from which the product was purchased for any questions or service.

Based on the Warranty, your product is repaired free of charge during the warranty period.

Any repair service will be charged after the warranty period.

All the costs of shipping, packing, parts and repair of the service are the responsibility of the customer.

 <p>Regular check up</p>	<p>Inspect the Rice Cooker you have been using for a long time!</p>	<p>Please check "Instructions for safety" and "Attention" regularly when using the cooker. Parts may deteriorate with heating, humidity, dust, etc. due to improper use or long-term use of the Rice Cooker, resulting in malfunction or accidents.</p>	<p>Stop use</p>
	<p>Does your cooker have any of following problems?</p> <p>Remove dust accumulated on the power plug and the electrical outlet.</p>	<ul style="list-style-type: none"> • The power plug or cord becomes abnormally hot. • The main body smells burnt. • The main body has a crack, looseness or rattling. • The inner pot, outer lid or inner lid is deformed or damaged. • The bottom fan does not run during cooking. • Other abnormalities or failures are observed. 	

TOSHIBA LIFESTYLE PRODUCTS & SERVICES CORPORATION

25-1, EKIMAE-HONCHO, KAWASAKI-KU, KAWASAKI, KANAGAWA, 210-8543, JAPAN

TOSHIBA

IH Rice Cooker (for household use)

Instruction Manual / Recipes

Model No.

1.0 L type

RC-DR10T

1.8 L type

RC-DR18T



For 220 V AC only

Make sure that the rating of the electrical outlet is 220 V AC.

Thank you for purchasing this Toshiba IH Rice Cooker.

- Please use this rice cooker for household purposes only. (It is not intended for commercial use.)
- For proper and safe use, please read this Instruction Manual carefully before use.
- Please be sure to keep this Manual at hand for quick reference in the future.
- Be sure to keep the instruction manual and the warranty for future use.

For proper and safe use of this rice cooker, please read "Instructions for safety" and "Attention". (Pages 2 to 7)

Contents

Before use

Instructions for safety.....	2
Attention.....	6
Setting the clock to the current time ...	7
Names and handling of parts	8

Cleaning

Cleaning	10
----------------	----

How to cook

Tips for cooking tasty rice	12
Using different rice cooking courses... 14	
Cooking rice	16
Setting the timer	18
Keep Warm mode	19

Recipes

Mixed rice with ingredients / Sweet rice with red beans (Cooked sweet rice) ...	20
Chicken congee / Sushi rice	21
Cooking (<蒸 Steam>, <蛋糕 Cake>, and <炖汤 Soup>) ...	22
Sweet rice with red beans (Steamed sweet rice) ...	23
Steamed gyoza (potstickers) / Shumai (pork dumplings) ...	24
Dome sponge cake	25
Pineapple coconut cake	26
White radish and pork spare rib soup / White radish, corn and pork backbone meat soup ...	27

Troubleshooting

Troubleshooting.....	28
Error display	31
Specifications	32
Warranty (Attachment)	32
Repair service	32