

# TOSHIBA

Leading Innovation >>>



Model No.  
1.0 L type

## RC-DX10H RC-DX10HA

1.8 L type

## RC-DX18H RC-DX18HA

Vacuum & Pressure IH Rice Cooker  
(for household use)

# Instruction Manual

With recipes

The interior of the pressure-type rice cooker develops a high pressure. Improper use will cause a hazardous situation. For proper and safe use, please read this Instruction Manual carefully.

### For 220 V AC only

Make sure that the rating of the electrical outlet is 220 V AC.

Thank you for purchasing this Toshiba Vacuum & Pressure IH Rice Cooker.

- Please use this rice cooker for household purposes only. (It is not intended for commercial use.)
- For proper and safe use, please read this Instruction Manual carefully before use.
- Please be sure to keep this Manual at hand for quick reference in the future.
- Please be sure to receive the warranty.

For proper and safe use of this rice cooker, please read "Instructions for safety" and "Attention" (pages 2 to 7).

## Contents

Before use	<b>Instructions for safety</b> .....	2
	<b>Attention</b> .....	7
	Name of each part .....	8
	• Power cord connection .....	8
	• Opening the outer lid .....	10
	• Closing the outer lid .....	11
Cooking rice	• <b>VACUUM</b> indication .....	11
	• Cooking time display .....	11
	• Attaching and removing the inner lid and steam vent (filter) .....	12
	How to cook rice .....	13
	Checkup before cooking .....	13
	Basic procedure .....	14
	• Tips for cooking tasty rice .....	15
	Cooking courses .....	16
	• <b>Guide for amount of rice to be cooked and cooking time</b> .....	16
	• Setting the type of rice and cooking course .....	17
	Using different cooking courses .....	18
Setting the timer .....	20	
• <b>Setting the clock to the current time</b> .....	21	
Keep Warm mode (reheating rice) .....	22	
Cleaning	Cleaning .....	24
	• Cleaning by boiling .....	25
Mastering the cooker	Recipes .....	26
	Cooking in <Steam>, <Cake> and <Soup> courses .....	29
	• <Steam> .....	30
	• <Cake> .....	32
	• <Soup> .....	34
Troubleshooting	Sounds .....	35
	Changing the settings .....	36
	Troubleshooting .....	37
	Error display .....	41
	• <b>When a power failure occurs</b> .....	42
	• <b>Lithium battery</b> .....	42
	Specifications .....	43
Warranty (Attachment) .....	43	
Repair service .....	43	

# Instructions for safety

Please follow these instructions without fail

■ Hazards and damage caused by failure to observe instructions for using this product are classified according to their degree, and are indicated by the following safety icons.

 **WARNING** This indicates that incorrect use may result in death or severe injury to the user.

 **CAUTION** This indicates that incorrect use may result in injury to the user or property damage.

■ Instructions to be observed are indicated according to the following classifications.

 Shows things you are prohibited from doing.

 Shows instructions you need to observe.

 Shows notes you need to pay attention to.

 **WARNING** To avoid fire, burn, electric shock, electrical leak, short circuit, etc.

 **This product should not be used by the following persons:**

- Children
- Those who have less physical, perceptual, or intellectual ability
- Those who do not have sufficient experience and knowledge (including babies and children).

Please make sure to prevent babies and children from playing with this product, and put it out of the reach of babies and children.

 **Do not use the product inappropriately or for any other purpose than those described in the instruction manual.**

It may cause fire, burns, injury or electric shock.

Toshiba is not responsible for any harm that may occur if the product is used inappropriately or for any purpose not described in this manual.

 **Stop using the product if it malfunctions or breaks.**

Immediately unplug the power plug, and contact the shop from which the product was purchased.

#### Examples of malfunctions

- The power plug or cord becomes abnormally hot.
- The main body smells like something burning.
- The main body is partly cracked, loose or rattling.
- The inner pot, outer lid or inner lid is deformed or damaged.
- The bottom fan is not running during cooking.

 **Do not disassemble, repair or modify the product.**

For repairs, contact the store from which the product was purchased.

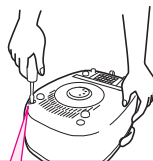

Do not disassemble

 **Do not immerse the cooker in water or pour water over it.**



Do not get wet

 **Do not put foreign objects into the air inlet, air outlet or any gap.**

Especially metal objects such as pins, wire, or the like.

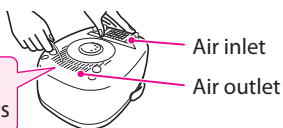

Do not insert foreign objects

 **Do not let children use the cooker alone, or place the cooker in a location within the reach of children.**



 **Do not open the lid or move the cooker during cooking or cleaning by boiling.**

\* The illustrations shown in the Instruction Manual may differ from the product you purchased.

**⚠ WARNING** To avoid fire, burn, electric shock, electrical leak, short circuit, etc.

**Use the power plug, cord and outlet correctly.**



**Do not allow pins or dust to adhere to the power plug (power supply side/main body side).**

**Do not use if the plug is loose in the outlet.**

**Do not use if the power plug (power supply side/main body side) or the cord is damaged.**

Always replace with the specified power cord.

**Do not use a power cord other than the specified one.**

**Do not use the power cord for other appliances.**

**Do not damage the cord or bend it unreasonably, pull, twist or bundle it, place it near hot parts of the appliance, place heavy objects on it, interpose it between other devices, or modify it.**



**Do not plug or unplug the power plug (power supply side/main body side) with wet hands.**

Ensure that your hands are dry before touching the plug.

**Do not allow children to lick the power plug (power supply side/main body side).**

Make sure that children and infants do not lick the power plug.

**Make sure that the power cord is out of reach of children.**

Do not allow the cord to dangle from a table or counter. If the cord is pulled, the product may fall from the table or counter and cause injury.

**Be sure not to stumble or trip on the power cord when the cooker is in use.**

It may cause injury, or the cord may become damaged and cause a fire or electric shock.

**Use a properly earthed outlet.**

The power plug of this product is designed to be used in an earthed outlet. If the outlet is not properly earthed, it may cause damage or electrical leaks.



**Plug the product into a 220V AC outlet with a rating of 10A or more. Do not share the outlet with other appliances.**

Sharing the outlet with another appliance may cause a fire due to heat generation.

**In case of using an extension cord, use the one rated at 10A or more standalone. Do not share it with other appliances.**

**Plug in the power plug (power supply side / main body side) fully.**

**Regularly remove dust from the power plug (power supply side/main body side).**

If dust accumulates on the power plug and becomes damp, it may cause insulation failure and lead to a fire. Wipe off dust with a dry cloth.

(continued)

# Instructions for safety (continued)

**Be sure to observe the following precautions when using this pressure-type rice cooker.**

**⚠ WARNING** The cooker develops a high pressure during cooking. Improper use may cause a hazardous situation.

**To prevent burns due to sudden opening of the outer lid**



**Do not select the <Quick> or <Quick2> course for cooking mixed rice.**

As rice is cooked on high heat when the <Quick1> or <Quick2> course is selected, ingredients may easily get stuck to the inner lid.

**Do not put things that may block the steam vent (filter, pressure regulating part, safety valve, and check valve) in the pot.**

**Examples of things that must not be put in the pot:**

- Sheet-shaped ingredients such as greens, tomato skin, beans, etc.;
- Oven sheet, aluminum foil, plastic wrap, and scum removing sheet; and
- Foods in a plastic bag to be heated in the pot.



**Close the outer lid securely until it clicks.**

Center of outer lid front



**Check if the safety valve works and there is no foreign object, and attach the filter before cooking.**

\* See page 12 for how to check.

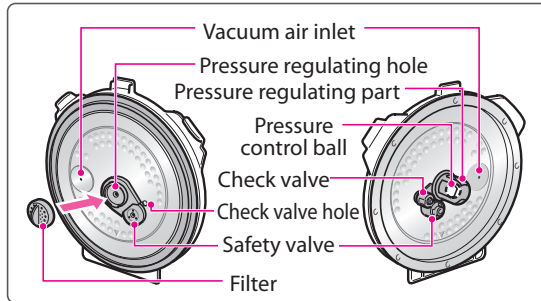

**Clamp receiving parts**  
\*You may not be able to open the outer lid if rice grains are stuck to the clamp receiving parts and hardened.

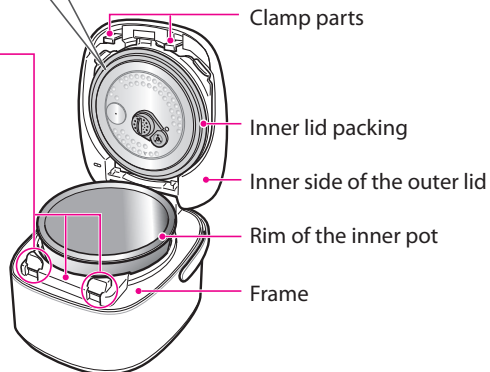

**⚠ WARNING**

**The cooker develops a high pressure during cooking. Improper use may cause a hazardous situation.**

**To prevent burns caused by ejection from inside the cooker**

**Do not open the lid while the **Pressure** indication is lighting or flashing.**

To open the outer lid by pressing the OFF key while the cooker is in the Cook mode, or when a power failure has occurred, make sure that the **Pressure** indication is off.

**Do not forcibly press down the open button when you cannot physically press it down to open the outer lid.**

Leave the cooker for a while until the main body has cooled down and the pressure inside is reduced.



**If you need to open the outer lid during cooking, follow the procedure for opening the outer lid during cooking on page 10.**

**Make sure that no people are nearby.**

**To prevent burns caused by hot steam**

**The steam vent is extremely hot. Do not place your hands and face near the steam vent.**

In particular, keep the cooker out of the reach of babies and children.

Extremely hot steam and water drops come out of the steam vent.

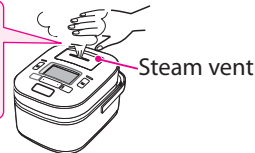

**Do not shake or carry the cooker while cooking.**

**To prevent burns caused by boiling over**

**Do not use the product for any other purpose than those described in the instruction manual.**

**Examples of food that should not be prepared in the cooker:**

- Foods that expand after cooking such as fish pastes, steamed beans and noodles;
- Foods that use baking soda, etc. that may suddenly foam up;
- Thick foods such as curry and stews;
- Foods using a large amount of oil;
- Foods that can easily boil over, e.g. beans, jam, etc.; and
- Heating of foods in a plastic bag with the rice cooker.

**For cooking congee, brown rice and soup which use a large amount of water, do not use the <Quick1> or <Quick2> course.**



**Do not increase the amount of water too much.**

The allowable additional amount of water is up to 2 mm over the water level scale as a guide.

**Do not add water exceeding the MAX water level on the inner pot for cooking.**



**Attach the steam vent securely.**

# Instructions for safety (continued)

Please follow these instructions without fail

## CAUTION

To prevent an injury, burn, electric shock, electrical leak, fire and property damage.

### Do not use in the following places



#### A place exposed to water or close to fire.

Be careful with the accessories as well.

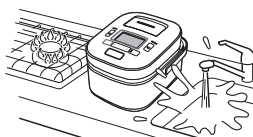

#### An unstable place or on a mat which easily catches fire.

It may cause burns, injury or fire.

#### A place where the air inlet / outlet will be blocked.

On paper, fabric, carpet, plastic bags, etc.

#### On aluminum foil or an electric carpet.

Aluminum foil, etc. may be heated.



#### A place near walls and furniture.

When using in a kitchen shelf, make sure that steam does not stay inside the shelf.

#### On a sliding table with insufficient load strength.

Use a surface that can support a weight of 15 kg or over for the 1.0 L cooker, and 20 kg or over for the 1.8 L cooker.

#### A place where the outer lid cannot be fully opened.

It may cause burns or damage.

#### A place near curtains that are not heatproof.

### To prevent burns



Do not touch the hot parts (the inner lid, inner pot, steam vent, heating plate, frame, etc.) during use and for a while after use.



Do not use the cooker while the inner pot is empty.

It may cause damage, overheating or malfunction.



Do not touch the open button when carrying the main body.



Before cleaning the cooker, unplug the power plug and wait until the cooker has cooled.

Hot water may have accumulated in the steam vent.

Do not shake the appliance while holding the handle.

Do not raise the handle while rice is being cooked.

Watch out for steam coming out of the cooker and hot water falling from the inner lid when opening the outer lid after cooking.

### For safe use of the product



If you use a heart pacemaker, consult a doctor before using this product.

The operation of this product may affect pacemakers.



Hold the power plug (power supply side/main body side) when unplugging it from an electrical outlet or the main body.

It may cause an electric shock or catch fire due to a short circuit.



Only use the inner pot provided with the appliance.

Do not apply steam to the power plug and other electrical appliances.

Be especially careful when placing the product on a kitchen shelf, etc.

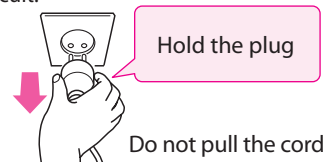

Do not use the cooker if there are any small metallic objects or aluminum foils, etc. in it.

Aluminum foil, etc. become extremely hot.

Unplug the power plug (power supply side) from the outlet when the product is not in use.

Otherwise the insulation may deteriorate and result in an electric shock or fire due to an electrical leak.

# Attention

Please follow these instructions to prevent product failure and malfunction.

## Location to place and surrounding environment

**Do not place the cooker in any place exposed to direct sunlight, or spattering of oil or the like.**

It may cause discoloration or deformation.

**Keep the main body and its surrounding area clean.**

Otherwise, dust or insects will enter the main body through its air inlet/outlet which maintains the function of the cooker, resulting in damage.

**Do not place objects susceptible to magnets near the cooker.**

The memory on objects such as cash cards, smart cards, etc. may be erased.

Noise may be generated on appliances such as TVs, radios and telephones.

## Using the cooker

**Do not use the cooker when foreign objects or water droplets are attached.**

Otherwise, you may not be able to cook tasty rice or close the outer lid, the vacuum function may not work, or the outer lid may be deformed or damaged.

\* For checking, see page 13.

- If there are foreign objects stuck in any part of the inner lid, inner lid packing, inner pot rim, vacuum air inlet, vacuum air outlet, clamp receiving part or clamp part, the cooker will not create a vacuum.

**Do not use the cooker on an induction heating cooker.**

It may cause malfunctions.

**Regularly check the air inlet/outlet on the bottom of the main body, and remove any dust.**

**Do not cover the lid, especially the steam vent, with a dishcloth, towel, etc.**

Steam may become trapped causing deformation, discoloration or damage of the outer lid, steam vent or operation panel.

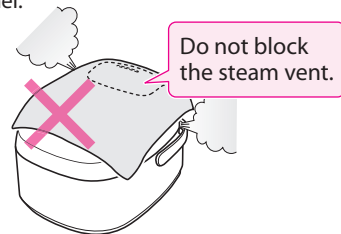

**Stop using the product if it is dropped and a crack or rattling is found.**

Contact the store from which the product was purchased.

## Handling of the inner pot

**Do not put the inner pot on a gas cooking stove or induction heating cooker, or in a microwave oven or other similar appliance.**

It may cause deformation or discoloration, resulting in damage.

**To avoid scratching or peeling-off of "fluorine resin coating" on the inner surface of the inner pot, do not use them in any of the ways below.**

**Avoid scratching and be careful with salt, acid and detergent.**

- Do not put dishes in the inner pot and use it as a washing-up bowl.
- Do not use a scrubbing brush, or dishwasher/dryer for cleaning it.



- Do not use cleanser, bleach, etc. (Use neutral detergent for kitchen use.)
- Do not keep mixed rice and soup warm. (Clean the pot immediately after using seasonings.)
- Do not use vinegar.
- Do not rub the inner pot with the rice scoop. Do not hit the inner pot with a sieve.
- Do not use a metal ladle or mixer, etc.

The surface of the "fluorine resin coating" may become uneven color with use. This does not affect its hygienic quality. You can use it without any problem.

\*Even when the coated outer surface of the inner pot is scratched, you can use the cooker to cook rice and keep it warm without any problems.

When using the inner pot for washing rice, place a cloth, etc. under the inner pot, so that the bottom of its outer surface will not be easily scratched.

# Name of each part

- Wash the inner pot, inner lid, filter, steam vent and accessories before using the cooker for the first time. (See page 24)
- The cooker may smell of plastic, etc. at the first use but the smell will decrease with use. (See page 41)

## Main body

Attaching and removing the inner lid, filter and steam vent (See page 12)

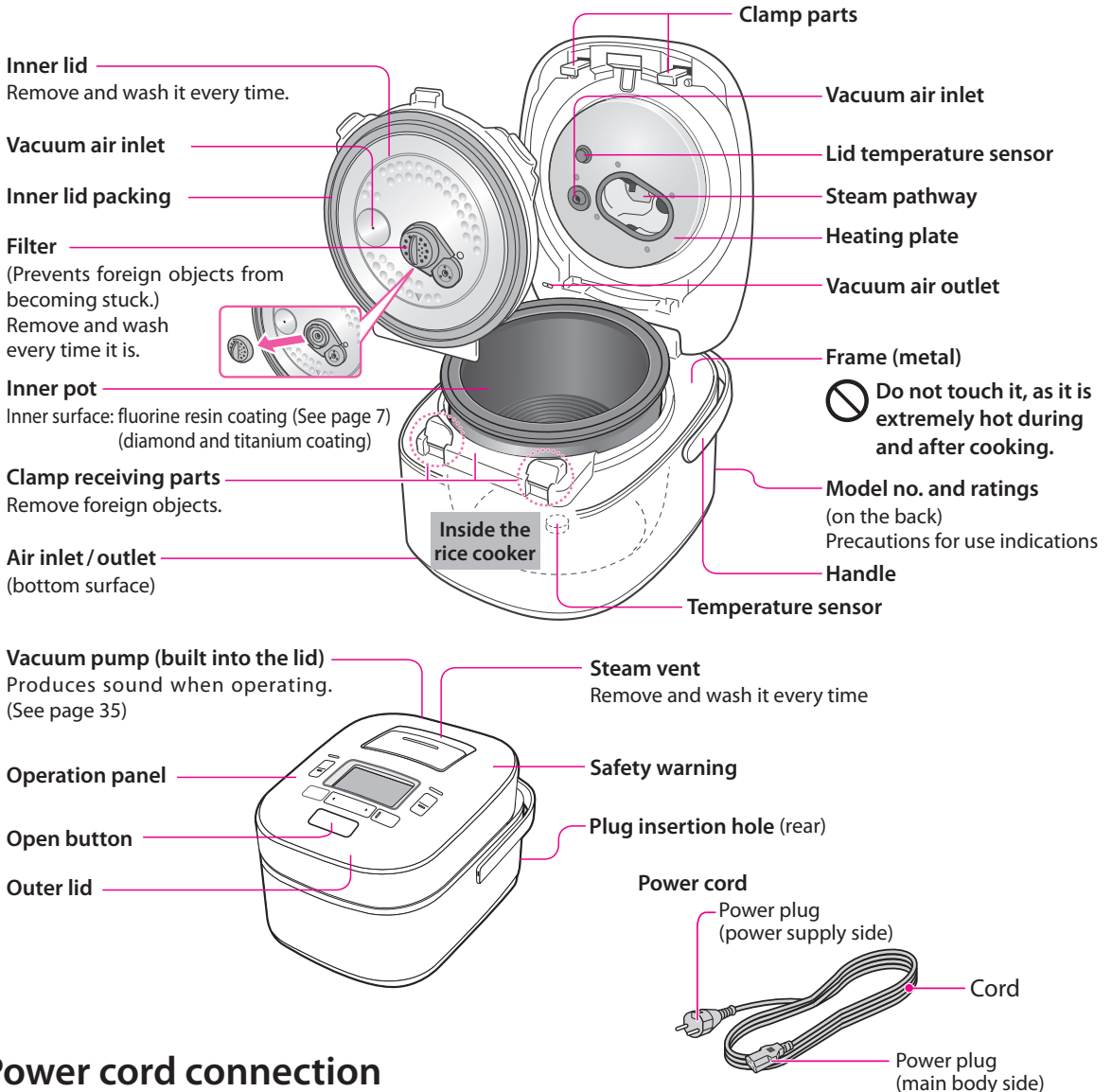

## Power cord connection

- Insert the power plug (main body side) into the plug insertion hole on the rear side of the main body.

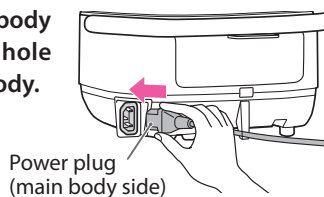

**!** Insert the power plug into the hole completely.

- Insert the power plug (power supply side) into the electricity outlet.

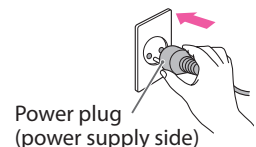



# eco mode

As this mode reduces the amount of electricity used, while still prioritizing taste, the rice may be slightly harder or slightly more watery than normal.

In this mode the vacuum pump does not operate and a vacuum is not created when the timer is set or when keeping rice warm. (VACUUM does not light up.) Do not keep rice warm for longer than 12 hours. The cooker will keep the rice warm for longer, but after 13 hours the display will flash. If you wish to keep rice warm for longer than 13 hours, do not use <eco mode>.

## Operation panel

There are a protrusions on the **START** and **OFF** keys, and Japanese braille markings near all of the keys.

### Pressure indication

Lights when pressure starts to be applied, and stays lit until the rice is cooked.

(It does not light for the following <White> and <Washed> modes: <Delicious Hard>, <Okoge>, <Mixed Okoge> and <Congee>.)

### Vacuum indication

Lights when the vacuum pump is set to operate in keep warm mode and when the timer is set.

### Display (24 hour clock display)

When all indications are displayed

### Vacuum lamp

Lights when the cooker has created a vacuum. (See page 11)

### eco mode lamp

Lights when cooking rice in <eco mode>.

### Quick1 key

(See page 17)

### KEEP WARM lamp

### KEEP WARM key

### OFF key

### ◀ (Go back) key

### RICE / MENU key

(Setting the type of rice and cooking course.)

### ▶ (Go forward) key

Also used to change the time by holding the key down. (See page 21)

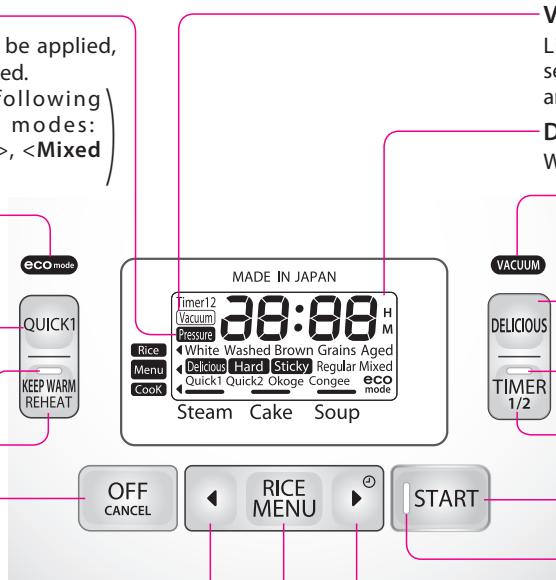

A lithium battery is included in the cooker to keep time and memorize the cooking courses. The battery power is drained as the rice cooker is used. (For details, see page 42.)

## Accessories



Measuring cup (About 180 ml)



Rice scoop



Rice scoop holder

The rice scoop can be placed upright or on its side in the holder.

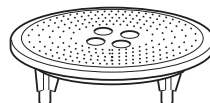

Steaming stand

## Opening the outer lid

Press the open button to open the lid.

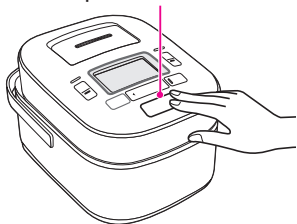

- ⊘ Do not open the lid while the **Pressure** indication is lighting or flashing.
- ⊘ When the open button is difficult to press down and the lid will not open, do not press the open button forcibly. (See how to open the lid on page 39.)

**As the cooker creates a vacuum, the lid seals very efficiently, and it may take some time to open the outer lid.**

It takes longer to open when the main body is warm (e.g. when keeping rice warm) than when it is cool.

Lighting

VACUUM

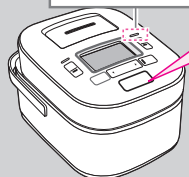

--In the Keep Warm mode--

To open the outer lid while the **VACUUM** indication is lighting

Press the open button twice to open the outer lid.

**Vacuum is released with the first pressing of the open button, and the second pressing opens the outer lid.**

- Depending on the way the open button is pressed (e.g. if it is pressed for a while), the lid may open after it is pressed once. This is not a malfunction.

### If you need to open the outer lid during cooking

- ❗ **If you need to open the out lid during cooking, observe the following procedure.**  
For your safety, the outer lid is kept locked while the cooker is in the Cook mode. You cannot open the outer lid by pressing the open button.
- ⊘ Do not place your hands and face near the steam vent. Hot steam suddenly comes out of the steam vent.

**1** Press the OFF key (the cooker will beep consecutively several times).

Wait for 2 minutes.

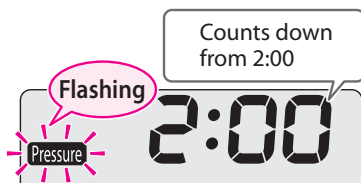

\*If you press the OFF key and hear a long beep, the lid can be opened.

**2** When the buzzer sounds, open the outer lid.

- ❗ Before opening the outer lid, make sure that the **Pressure** indication is off.



- ⊘ When you cannot open the outer lid because the open button is too heavy to press down, do not forcibly open it.

(When you resume cooking, start the cooking procedure again from the start. However, rice may not be properly cooked.)

## Closing the outer lid

Press the front center of the lid.



! Press down the outer lid until it clicks.

• The outer lid cannot be closed when the inner lid is not attached.

! Before closing the outer lid, make sure that there are no foreign objects in the clamp receiving parts. (See page 13)

**As the cooker creates a vacuum, the lid seals very efficiently and it may be difficult to close the lid.**

The outer lid is more difficult to close when the main body is warm (e.g. when keeping rice warm) than when it is cool.

## Vacuum indication

• The Vacuum indication lights up when cooking starts<sup>\*1</sup> and preset cooking starts<sup>\*2</sup>, and the lamp turns off after a while.  
(The lighting duration of the indication varies depending on the cooking course, water temperature, timer setting, etc.)

\*1: The indication may not light up at the start of cooking while the inside of the cooker or the inner lid is warm.

\*2: The indication does not light up in <eco mode>.

• See page 22 for information about the Vacuum indication in the Keep Warm mode.

Lights when the cooker has created a vacuum

VACUUM



When the open button is pressed or the outer lid is opened while the **VACUUM** indication lights up (in the timer setting mode or in the Keep Warm mode), the **VACUUM** indication turns off.



Even when the vacuum is released, the timer will continue / the rice will still be kept warm.

- In the timer setting mode, rice will be cooked with no vacuum created any more.
- In the Keep Warm mode, another vacuum will be created after approximately 30 minutes.

## Cooking time display (time remaining display)



The time until the completion of cooking is displayed in **increments of 5 minutes**.

When steaming of rice starts, it is displayed in **increments of 1 minute**.

In order to adjust the displayed time, the clock may run fast or stop until the cooker is in the steaming stage. Use the displayed time as a guide.

## Attaching and removing the inner lid and steam vent (filter)

### Removing the inner lid

Hold the knob with one hand, press the lock button and pull the knob forward.

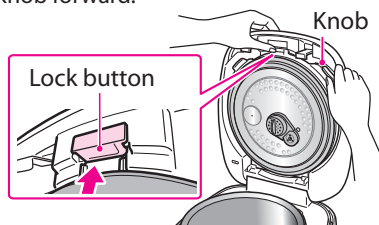

### Attaching the filter

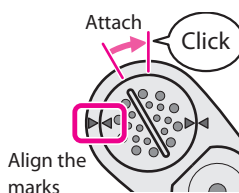

Turn the knob of the filter until it comes to its vertical position.

\* The filter may come off while cooking unless you completely turn it until it clicks.

• To detach the filter, turn it in the opposite direction.

### Attaching the inner lid

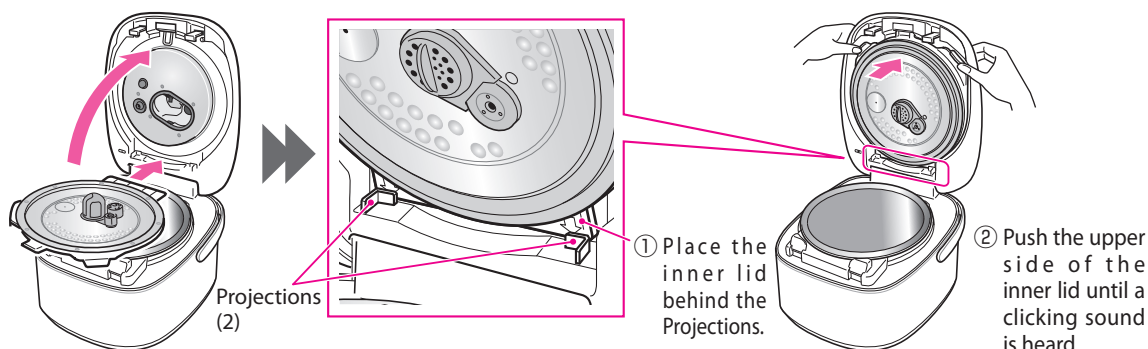

### Removing the steam vent from the main body



Pull the steam vent upward.

• Push in the steam vent to attach it.

### Disassembling the steam vent

Unlock the lock with the case and the cap held as shown.

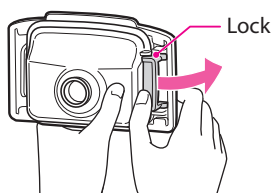

### Assembling the steam vent

Insert the projection on the case into the hole in the cap and secure the lock firmly.

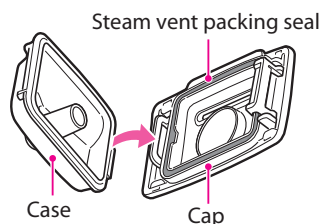

• If the steam vent packing seal in the inside of the cap has come loose, press it into the groove.

# How to cook rice **Checkup before cooking**

**!** Check the following items before starting to cook.  
Remove any foreign objects or water droplets, if any.

\* For the reasons for checkups, see pages 4, 5 and 7.

**Inner lid** Remove foreign objects Check the valves Attach the filter

If there are foreign objects in any of the parts below, remove them with a bamboo skewer or toothpick.

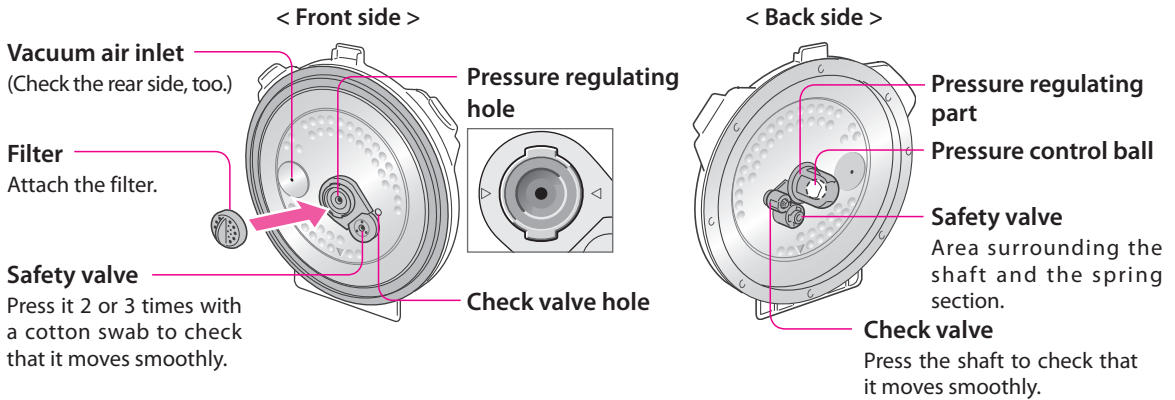

## Clamp receiving parts

Remove foreign objects

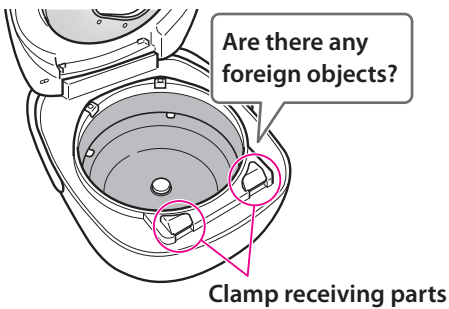

Removing foreign objects  
→ page 25

## Temperature sensor and other parts

Remove foreign objects Wipe away water drops

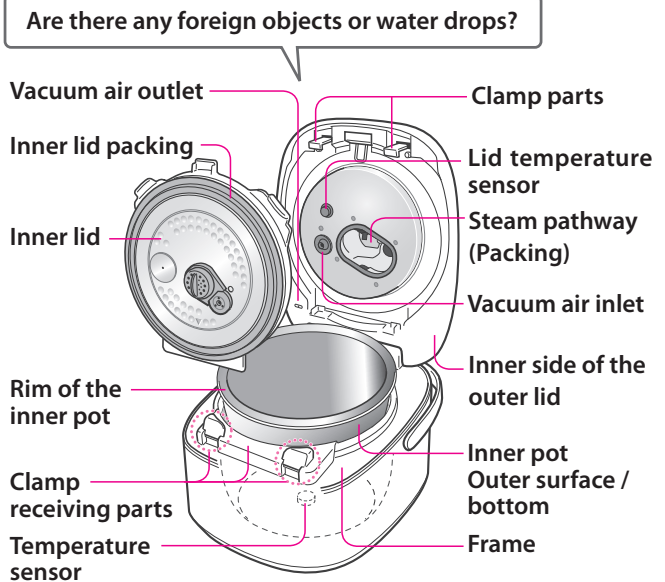

When the temperature sensor is dirty  
→ page 25

## Steam vent Attach

Is the steam vent attached?



# How to cook rice Basic procedure

Sounds while in use (See page 35)

## Preparation

❗ Inspection before cooking rice (See page 13) ▶ Power cord connection (See page 8)

Basic procedure

### 1 Measure rice in the measuring cup provided.

One level cup is about 180 ml.

[Good example]



[Bad example]

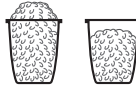

- There may be errors in measurement if a standard measuring cup for cooking (200 ml) is used.

### 2 Wash the rice quickly, until water becomes clear.



You can wash rice in the inner pot.

- ① First, add plenty of water, mix quickly, and drain the water immediately.
  - ② Wash the rice and drain the water several times until the water becomes clear.
- Do not use a metal whisk or the like when washing the rice in the inner pot.

### 3 Adjust water. Select the water level scale on the inner pot according to the number of cups, and put water to the scale.

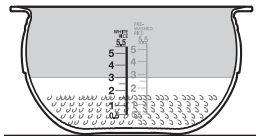

Level the rice, and place the inner pot on a level surface.

Adjust the amount of water to the water level scale for **White rice** when cooking white rice. (For other water level scales, see page 16.)

- Adjust the amount of water according to your preference. (❗ The permissible additional amount of water is up to 2 mm above the water level scale as a guide.)

### 4 Place the inner pot in the cooker, and close the outer lid.



Wipe off any water drops on the outer surface of the inner pot.

Press the center of the lid front.



❗ Press the outer lid until it clicks.

- \* Always press the **START** key after closing the outer lid. (When you close the outer lid after pressing the **START** key, the outer lid is not securely closed and may be opened during cooking.)

### 5 Select and check the cooking course before starting to cook.



Press the **START** key.



The time until rice cooking is complete is displayed. (It is displayed in increments of 5 minutes. For details, see page 11.)

The outer lid is locked when the **START** key is pressed. (See page 10)

- The **START** lamp and **VACUUM** light up when the **START** key is pressed. The **VACUUM** indication turns off when the vacuum is released.
- \* The vacuum pump soon starts operating and produces sound for a few minutes.

Cooking will not start if the inner pot is not placed correctly.

**When the buzzer sounds the rice is cooked.**

The **KEEP WARM** lamp lights up.

▶ After use, press the **OFF** key, and unplug the power plug.

- You do not need to soak rice prior to cooking. (When the **START** key is pressed, rice automatically starts soaking.)
- When you cook rice soon after stopping the Keep Warm mode or cook several batches of rice consecutively, cool down the inside of the cooker and the inner lid to a body temperature before starting to cook rice. (Otherwise the rice may not be cooked well, and a vacuum may not be created when cooking starts.)

## Tips for cooking tasty rice



### Measure rice while leveling off



Do not shake the measuring cup.

Measuring cup provided

If you shake the measuring cup, an excessive amount of rice will be put in the cup.

### Do not wash rice with hot water Do not wash rice for too long

Washing it with hot water or taking too long will make it smell of bran.

### Wash rice gently so as not to break it

To wash the rice, gently rub the rice grains against one another with your hands. (Broken rice grains can cause mushy rice.)

### Adjust the amount of water as necessary

For harder rice	Put less water against the scale.
For softer rice	Put more water against the scale.
For freshly-harvested rice	Put less water against the scale.
For whole rice	Put the amount of water on the scale.
For old rice During the rainy season and in summer For rice with barley	Put more water against the scale.

Adjust the amount of water according to cases, as it varies depending on the type and area where the rice was harvested, and how it was stored.

### Loosen rice immediately after it has been cooked

By doing so, coagulation and stickiness of the rice can be avoided.

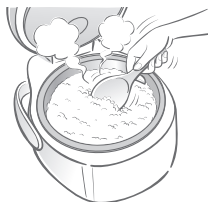

### Do not keep the rice warm for too long

Instead of keeping rice warm for a long time or keeping small volume of rice or mixed rice warm, it is recommended to wrap the rice in plastic wrap and store it in the freezer. (For information about Keep Warm mode, see pages 22 and 23.)

### About rice

- It is recommended to purchase rice which has been polished as recently as possible in such volume that you can eat up within two weeks to a month.
- Preserve rice in an airtight container in a cool and dark place to avoid oxidation.

### Do not leave rice in a sieve basket after washing it

Avoid leaving rice in a sieve basket after washing it.



The rice cracks and becomes mushy when cooked.

### Water that is not appropriate for cooking

Hard mineral water



Ionized water over pH 9

(It causes drying out or hardening of rice.) (It causes a yellow discoloration or mushy rice.)

### Water temperature of 30°C or less

It is recommended to use cold water when you cook rice by setting the timer in hot weather.

Use cold water in summer.



(A high water temperature causes poorly-cooked rice and/or bad odors.)

### Clean the cooker immediately after use

Wash the inner lid and steam vent and keep them clean.

After washing the inner lid and steam vent, wipe them with a clean dishcloth to remove water.

Remove and wash the filter.

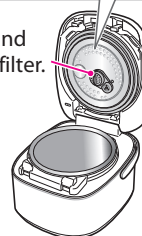

(If the rice cooker is left dirty, it can cause bad odors.)

**Do not leave rice in the pot after turning off Keep Warm mode.**  
(It may cause a bad odor.)

(See pages 24 and 25 for more information about cleaning.)

# Cooking courses

Guide for amount of rice to be cooked and cooking time



Select the cooking course appropriate to your choice and water level scale on the inner pot.

- Select your preferred cooking course for white or pre-washed rice. (See page 18)
- See page 19 for tips for cooking rice.

To cook...	Course		Water level scale	Cooking volume Unit: Cups ( ) indicates the max. cooking volume when adding ingredients		Approximate cooking time Unit: Minutes The number in brackets is the displayed cooking time		
	Type of rice	Cooking course		1.0 L type	1.8 L type	1.0 L type	1.8 L type	
Rice (White rice / Pre-washed rice)	White or Washed*	Delicious	White rice / Pre-washed rice	0.5 to 5.5	1 to 10	50 to 60 (55)	55 to 70 (60)	
		Hard				35 to 45 (40)	40 to 55 (45)	
		Sticky				50 to 60 (55)	55 to 70 (60)	
		Quick1				25 to 35 (30)	25 to 40 (30)	
		Quick2			0.5 to 4*	1 to 6*	17 to 26 (20)	20 to 30 (25)
		Regular					45 to 55 (50)	50 to 65 (55)
		Okoge			0.5 to 5.5	1 to 10	65 to 75 (70)	65 to 80 (70)
		eco mode					45 to 55 (50)	50 to 65 (55)
		Mixed rice			Mixed			
		Mixed Okoge		1* to 4*	2* to 6*	40 to 50 (45)	45 to 60 (50)	
Sweet rice		Mixed	Sweet rice	2 to 4	3 to 6			
Sushi rice		Regular	Sushi white rice / Sushi pre-washed rice	1 to 5.5	2 to 10	45 to 55 (50)	50 to 65 (55)	
Congee		Congee	Congee	0.5 to 1 (0.5)	0.5 to 1.5 (1)	95 to 105 (95)	95 to 105 (100)	
Aged rice	Aged	Regular	White rice / Pre-washed rice	0.5 to 5.5	1 to 10	55 to 65 (60)	55 to 70 (65)	
Brown rice	Brown	Regular	Brown rice	1 to 4 (3)	1 to 8 (6)	65 to 75 (65)	65 to 80 (70)	
Brown rice congee		Congee	Congee	0.5 to 1.5 (1)	1 to 3 (2)	80 to 90 (85)	85 to 95 (90)	
Rice with mixed grains (Germinated brown rice / Partially milled rice / Whole rice)	Grains	Regular	White rice / Pre-washed rice	1* to 4* (3)	2* to 8* (6)	55 to 65 (60)	55 to 70 (65)	

\*: This differs from the maximum and minimum amounts on the water scale.

\*: For <Washed> rice, the cooking time is approximately 5 minutes longer. (The displayed cooking time is also 5 minutes longer.)

- Actual cooking time may vary by about 10 minutes depending on the volume of rice, water temperature, amount of water, etc. Use the cooking time as a guide. (The cooking times are based on the following conditions: Voltage of 220V, a room temperature/water temperature of 23°C, and the standard amount of water.)
- When you want to cook softer congee, reduce the amount of rice or increase the amount of water. Be sure not to add water exceeding the max. water level scale on the inner pot for <Congee>.



# Setting the type of rice and cooking course

• When purchased, the default type of rice is <White>, and the default cooking course is <eco mode>. Try the "Delicious" setting for even tastier rice.

Operation	<b>Select the type of rice</b>	<b>Select the cooking course</b>
	<p><b>1</b> Press  <b>once.</b></p> <p>Type of rice                    ⤴ 1 short beep</p>	<p><b>1</b> Press  <b>twice.</b></p> <p>* Press once if you have already chosen the type of rice.</p> <p>Cooking course                    ⤴ 2 beeps</p>
	<p><b>2</b> Press    <b>to select.</b></p> <p>(Go back) (Go forward)</p> <p>The selected type of rice flashes  </p> <p>• The cooking courses displayed differ according to the type of rice selected.</p>	<p><b>2</b> Press    <b>to select.</b></p> <p>(Go back) (Go forward)</p> <p>The selected cooking courses flashes  </p> <p>* You can check the cooking course by pressing the RICE / MENU key again. The selected type of rice and cooking course will light up. (You may skip this step.)</p>
<p><b>3</b> Press  <b>Cooking starts</b></p> <p>Lights </p>	<p>The cooker memorizes the settings for the following cooking courses, so there is no need to set them each time.</p> <ul style="list-style-type: none"> <li>• For &lt;White&gt; and &lt;Washed&gt;: &lt;Delicious&gt;, &lt;Delicious Hard&gt;, &lt;Delicious Sticky&gt;, &lt;Aged&gt;, &lt;Regular&gt;, &lt;Quick1&gt;, &lt;Okoge&gt; and &lt;eco mode&gt;</li> </ul>	

<Quick1> Use keys to easily select <Quick1> and <Delicious>.

What are <Quick1> and <Delicious>? → page 18

## Quick settings



**1** Press

Press once to select <Quick1>.

- The memorized rice type will be selected.

↓

Press again to change the rice type.

- Every time the QUICK1 key is pressed, the rice type will change between <White> and <Washed>.

Press

Press once to select <Delicious>.

- The memorized rice type will be selected.

↓

Press again to change the cooking course.

- Every time the DELICIOUS key is pressed, the cooking course will change between <Delicious>, <Delicious Hard> and <Delicious Sticky>.
- To change the rice type from <White> to <Washed> and vice versa, select the type before you press the key.

**2** Press **Cooking starts**

- The START lamp lights up.

# Using different cooking courses



For <White> and <Washed> rice Select your preferred cooking course.

## When you want the rice to taste really good



**Delicious**

This is the default cooking course.

The cooker cooks rice slowly to bring out the intrinsic deliciousness of the rice.

\* After trying rice cooked using the Delicious setting, select the cooking course based on your preferences and the type of rice used.

- **Delicious Hard** : When you want the rice to be nice and firm.
- **Delicious Sticky** : When you want to eat rice that sticks together well, and is also soft.

## If you are in a hurry and want the rice to be cooked soon.



**Quick1**

There is time to make the rest of the meal when the rice is cooking.

Cooking time: approximately 28 minutes<sup>\*1</sup>

Quicker



**Quick2**

When you want the rice to cook as fast as possible

Cooking time: approximately 19 minutes<sup>\*2</sup>

- This cooking course prioritizes cooking speed, so rice may end up being a little bit hard, or slightly watery. (See page 19)
- Use the cooking time as a guide. See page 16 for more details.

\*1: When cooking 3 cups of <White> rice for both the 1.0 L and 1.8 L cookers.

\*2: When cooking 1 cup of <White> rice for both the 1.0 L and 1.8 L cookers.

## Other cooking courses...



**Aged Rice Regular**

This course helps aged rice and hard rice to soak up more water when cooking.



**Okoge**

When you want to eat fragrant okoge (slightly browned and crispy) style rice\*

\* The rice on the bottom of the pot turns golden brown. The color of the okoge varies slightly depending on the quality of the rice, how it was washed, and the amount of water it was cooked in. If the okoge is too pale, add 1 teaspoon of sake to every cup of rice to make it easier for the rice to make okoge.



**eco mode**

The taste is preserved, but the amount of energy consumed when cooking rice is reduced.

In eco mode the vacuum pump does not operate, and no vacuum is created. The rice cannot be kept warm for longer than 12 hours.

## When you cannot cook rice the way you like

If it is soft → Reduce water or select <Delicious Hard> for cooking.

If it is hard → Increase water or select the <Delicious Sticky> cooking course. Soak rice before cooking it.



Adjust amount of water for cooking within the range of 2mm against the water level scale.

## Tips for cooking rice

### Pre-washed rice

- When water is poured in, stir the rice from the bottom to mix the rice and water together. If the water becomes cloudy, drain the water and rinse it again 1 or 2 times. (This prevents the rice from cooking badly, scorching and boiling over.)
- Add water according to the **Pre-Washed rice** water level scale, and select the **<Washed>** course when cooking the rice.

### Using Quick1 / Quick2 For cooking white rice

- This cooking course prioritizes cooking speed, so rice may end up being a little bit hard, or slightly watery. To prevent this, soak the rice in water first, or steam it for longer after the cooker has entered the Keep Warm mode.
- **The following kinds of rice cannot be cooked using <Quick1> or <Quick2>.**  
Mixed rice / brown rice / congee / sweet rice / any other rice apart from white rice / pre-washed rice

### Mixed rice / sweet rice → When making "Mixed rice with ingredients" and "Sweet rice with red beans" see pages 26 and 27.

- For tips on cooking these types of rice, see "When you add ingredients and seasonings" on page 26.
- If you want the rice to have okoge (slightly browned and crispy rice) when making mixed rice, select the **<Mixed Okoge>** cooking course. (The color of the okoge varies depending on the quality of the rice, how the rice was washed, the amount of water and the seasonings used.)
- When making sweet rice, if only sweet rice is used, the cooked rice becomes too soft, so add 1 cup of standard rice to every 2 cups of sweet rice.

### Congee / brown rice congee

- ! **Be sure to choose the <Congee> cooking course.** (Otherwise, the cooker may boil over or you may get burned.)
- Add salt and other seasonings after the congee is cooked. (If seasonings are added from the beginning, the rice may not cook properly.)
- Depending on the type of rice, the water temperature, and how the rice was washed, water droplets of water may come out of the steam vent.
- Congee cannot be made from cooked rice.
- ⊘ **When making traditional Japanese congee that contains the 7 herbs of spring, do not mix the greens from the start.** (The steam vent may become blocked, causing steam leaks, burns and damage.)  
Boil the greens, and add them after the congee is cooked.

### Brown rice

- ! **Be sure to use the <Brown / Regular> cooking course.**  
(Otherwise, the cooker may boil over or you may get burned.)
- **<Brown>** takes longer to cook than white rice.  
The rice can be cooked immediately after it has been washed.

### Germinated brown rice

- We recommend cooking 2 cups of white rice for every cup of germinated brown rice. You may also cook germinated rice only.

### Rice with mixed grains (rice with barley)

- For the amount of mixed grains to be added to rice, follow the instructions printed on the package of the mixed grains. (If there are no instructions on the package, add the mixed grains at about 10% of the amount of the white rice to be cooked.)
- Add water to the appropriate water level for the kind of rice used: **White rice** or **Pre-Washed rice**.
- When cooking this type of rice the steam vent may become dirty, so be sure to clean the inside of it.

**If you are using grains that float in water,** soak the rice and grains for 2 to 3 hours, and only cook the rice when the grains have sunk.  
(Floating grains may block the steam vent, causing steam leaks, or the deformation or damage of the cooker.)

- Cook only small amounts of rice.  
Up to 3 cups (1.0 L cooker) / 5 cups (1.8 L cooker)

### When you want to cook brown and white rice together

- Soak the brown rice for 2 hours, and use the **<White / Delicious / Sticky>** cooking course.  
Try cooking it once, and then adjust the amount of water.

### Cooking courses when other grains are mixed with the rice

- When mixed with white rice → **<Grains / Regular>**
- When mixed with brown rice → **<Brown / Regular>**
- When mixed into congee → **<White / Congee>**
- When mixed into brown rice congee → **<Brown / Congee>**

# Setting the timer

When setting the timer, the vacuum pump and other parts produce sounds. (See page 35)



You can finish cooking rice at the timer set time.

As the cooker can memorize two time settings, you can use them in various ways, such as using **Timer1** for a breakfast, and **Timer2** for an evening meal.

Preparation	<p><b>Check to see that the current time is correct.</b></p> <p><b>Wash rice and adjust amount of water for cooking. Put the inner pot into the cooker main body and close the outer lid.</b></p>	<ul style="list-style-type: none"> <li>• If the current time is wrong, cooking cannot be completed at the preset time.</li> <li>• The timer cannot be set when inner pot is not in the cooker.</li> </ul>						
Operation	<p><b>1</b> Press  to select <b>Timer1</b> or <b>Timer2</b>.</p> <p><b>2</b> Use  (Go back)   (Go forward) keys to set the time for the completion of cooking.</p> <table border="1" data-bbox="257 977 525 1097"> <tr> <th colspan="2">24-hour clock display</th> </tr> <tr> <td>7 AM .....</td> <td>7:00</td> </tr> <tr> <td>7 PM .....</td> <td>19:00</td> </tr> </table> <p>Example: Completing cooking at 7:30 a.m.</p>	24-hour clock display		7 AM .....	7:00	7 PM .....	19:00	<ul style="list-style-type: none"> <li>• The display of <b>Timer1</b> and <b>Timer2</b> changes, each time the <b>Timer</b> key is pressed.</li> <li>• The timer clock can be set in <b>units of 10 minutes</b>.</li> <li>• If you press and hold the <b>Go back/Go forward</b> keys, the time will change quickly.</li> <li>* For a timer setting that does not exceed 2 hours, cooking starts immediately.</li> </ul> <p>The cooker memorizes the preset time, so you can skip this step the next time you want to set the timer.</p>
24-hour clock display								
7 AM .....	7:00							
7 PM .....	19:00							
	<p><b>3</b> <b>Check the course.</b></p> <p>You can use the timer for white rice, washed rice, brown rice, congee and brown rice congee.</p> <ul style="list-style-type: none"> <li>• Set the cooking course for what you want to cook.</li> </ul> <p>Set the course using the  or   key.</p> <p>(For details, see pages 16 and 17.)</p>	<p><b>!</b> <b>Make sure that you select an appropriate cooking course for brown rice, congee, and brown rice congee.</b></p> <p>(Otherwise, the cooker may boil over or you may get burned.)</p>						
	<p><b>4</b> Press  <b>The timer is set.</b></p> <p> is unlit  Lights</p> <ul style="list-style-type: none"> <li>• The vacuum pump soon starts operating and produces sound for a few minutes. The <b>VACUUM</b> indication lights up, and then turns off while the timer is set.</li> <li>* The indication does not light in <b>&lt;eco mode&gt;</b>.</li> </ul> <p>➔ <b>Cooking is completed at the preset time.</b></p>	<p><b>If the START key is not pressed, the cooker will beep 4 times.</b> The key must be pressed to complete the timer setting.</p> <ul style="list-style-type: none"> <li>• When cooking starts, the <b>START</b> lamp lights up. (The lamp stays lit up until cooking is complete.)</li> <li>• When cooking starts, the time to the completion of cooking is displayed. (For details, see page 11.)</li> </ul>						

To cancel the timer setting if an error is made in the operation

Press

When changing the timer settings for brown rice, congee, and brown rice congee, select the cooking course again.

# When cooking rice with the timer set

■ "X" means the timer should not be used. (Otherwise, the rice may have poor quality or may spoil, or the inner pot may corrode.)

White rice	Pre-washed rice	Brown rice	Congee	Brown rice congee	Mixed rice	Germinated brown rice	Mixed grains
○	○	○	○	○	×	×	×

■ Avoid setting the timer for longer than 14 hours (8 hours in summer).  
Long hours of a timer setting causes fermentation of rice, resulting in bad smell.

## Note

- If the rice turns out slightly mushy, reduce the amount of water as you like.
- In case of cooking with the timer set, the bottom surface of the cooked rice in the pot may become light brown because the starch in the rice settles at the bottom of the pot. To avoid this, wash the rice well.
- The actual time for completing the cooking may be delayed by about 10 minutes when room temperature or water temperature is low, or when the amount of water in the pot is increased.
- **After the START key is pressed and the timer is set, the vacuum pump operates and the VACUUM indication lights up.** The VACUUM indication turns off when the vacuum is released. The duration of time for which the VACUUM indication is on varies depending on the cooking course, water temperature, time set by the timer, etc. The VACUUM indication will light up for a longer period of time for the <Brown / Regular> and <Brown / Congee> cooking courses.
- In <eco mode>, the vacuum pump does not operate and no vacuum is created when the timer is set.
- \* If the open button is pressed, or the lid is opened when the VACUUM indication is lighting, the VACUUM indication turns off. (See page 11)

When using the timer **To check the current time while the timer has been set**

Press .

The current time is displayed while the key is pressed down.

At the same time

The cooker beeps to indicate the time until the rice will be cooked.

- ♪ 2 short beeps: Start and end signal
- ♪ A pattern of 3 beeps: 5 hours,
- ♪ 1 short beep: 1 hour





(Times under an hour are rounded up to an hour.)

Cooking rice

To stop the vacuum pump from making a sound while the timer is set → page 36 

## Setting the clock to the current time

The time is displayed using a 24 hour clock. (Midnight: 0:00/Noon: 12:00)

- 1 Plug in the power plug, and press the  key for 1 second or longer.**  
The display flashes.
- 2 Use  (Go back) and  (Go forward) keys to change the time.**  
Press and hold the keys to change the clock on fast forward, in units of 10 minutes.
- 3 Press  to complete the clock setting.**  
The clock display stops flashing.

- The clock cannot be set when cooking rice, keeping rice warm or preparing food, or when the timer is set.
- The cooker makes the following sounds when setting the time.
  - 12 midnight ..... ♪ a pattern of beeps
  - 12 noon..... ♪ the pattern of beeps is repeated twice
  - Every 10 minutes ... ♪ 1 long beep (does not sound when the time is being changed quickly)
  - Every hour..... ♪ 2 short beeps

# Keep Warm mode

The vacuum pump produces sounds when keeping rice warm. (See page 35)

When cooking is complete, the operation of the cooker switches to the Keep Warm mode automatically.

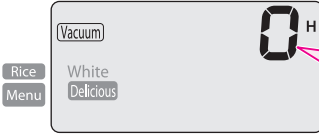

(The KEEP WARM lamp lights up.)

The elapsed time for keeping rice warm is displayed in units of 1 hour.

- To keep the rice warm without spoiling its flavor, the cooker controls the temperature depending on the conditions.
- Press the **OFF** key to stop keeping rice warm. (The KEEP WARM lamp turns off and the current time is displayed.)
- Removing the inner pot turns the cooker off automatically.

## Keep Warm with Vacuum



The cooker preserves the flavor of the rice by creating a vacuum in the inner pot.

The Vacuum indication lights up in a few hours\* after cooking is complete, and the cooker creates a vacuum.

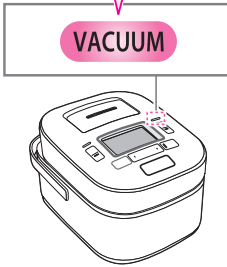

Opening the outer lid → page 10

- \*: Usually it takes 1 to 3 hours, but the time varies depending on the amount of rice and how well the rice has been loosened. If there is a large volume of rice, and it is not loosened, the **VACUUM** indication may not light up for 5 hours. When there is a small volume of rice, and it has been loosened, the Vacuum indication may light up within 1 hour.
- The vacuum pump operates regularly to maintain the vacuum. This produces some sounds.
- The cooker does not enter the vacuum state if the rice has been kept warm for 41 hours or longer.
- No vacuum is created in **<eco mode>**.



The **VACUUM** indication does not light up in the following cases

- When rice was cooked in **<eco mode>**.
- Within 1 to 3 hours after the completion of cooking\*.
- For 30 minutes after the outer lid has been opened in the Keep Warm mode.
- When the rice has been kept warm for over 41 hours.

(If the open button is accidentally pressed in the Keep Warm mode and the **VACUUM** indication turns off, it will turn on in 30 minutes.)

\* Rice becomes discolored easily in the following cases: When the amount of water was not sufficient for rice cooking; when rice was not washed sufficiently; when you are keeping small volume of rice warm; and when the lid has been opened and closed many times.

## Do's and don'ts when keeping rice warm

■ **Follow the guidelines at the time of keeping rice warm.** (Otherwise it can cause bad odors, dry rice, and discoloration.) Do not use the Keep warm mode for the courses marked with "X". (Otherwise it may cause deterioration of rice quality, spoiling of the rice or corrosion of the inner pot.)

eco mode	White · Washed	Brown · Grains	Congee	Mixed
○ (up to 12 hours)	○ (up to 40 hours)	×	×	×

- If you wish to keep rice warm for longer than 13 hours, do not use **<eco mode>**.
- **Do not leave the rice scoop in the inner pot** (this may cause bad odors).
- **Do not use the Keep Warm mode with cold rice** (this may cause bad odors).
- **Do not turn the Keep Warm mode off while rice is in the pot** (this may cause bad odors).

\*If the rice around the inside of the inner pot becomes mushy or develops a bad odor, check the troubleshooting guide on pages 38, and follow the procedure on page 36 to change the Keep Warm settings.

When the time for keeping rice warm exceeds the maximum time, the display flashes.

▶ Press the **OFF** key and remove the rice.

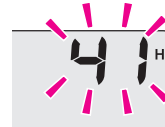

The display flashes after 41 hours. (A vacuum is not created.) 13 hours in **<eco mode>**.

### To start the Keep Warm mode when the cooker is off

**Operation**

Press  to enter the Keep Warm mode.



- The KEEP WARM lamp lights up.

**In Keep Warm mode To see the current time**

Press 

The current time is displayed while the key is pressed down.

**Tips for using the Keep Warm mode**

- The vacuum pump does not operate in <eco mode>.
- If you find that rice becomes mushy when it is kept warm, do not let rice adhere to the peripheral side of the inner pot and loosen the rice occasionally.
- If the rice will be kept warm for a long time, or a small volume of rice or mixed rice has been cooked, it is recommended to wrap the rice in plastic wrap and store it in the freezer.

### Reheating rice that is being kept warm

**Operation**

Loosen the rice being kept warm, and close the outer lid.

Press  to start reheating the rice (for 9 minutes).

➔ The buzzer sounds when reheating is complete. (The cooker goes back to the Keep Warm mode.)

- The KEEP WARM lamp flashes, and the time left for reheating is displayed.

**To stop reheating**

Press the KEEP WARM key to return to the Keep Warm mode.

- Do not operate the reheating as follows.
  - Repeat reheating. (Causes drying out or yellow discoloration.)
  - Reheat cold rice. (Causes bad odor.)
- Putting too much rice in the pot may cause insufficient reheating. (Do not allow the amount of rice to exceed half of the pot as a guide.)

### To change the sound volume produced by the vacuum pump

Use the following procedure to change the settings for pump operation in the Keep Warm mode.



Plug in the power plug, and start operating with the power off.

**1** Press  for 5 seconds or longer.

 Default setting when shipped

**2** Press  to change the setting.

(Go forward)

 The interval between vacuum pump operations becomes longer.

 The vacuum pump does not operate.

\* Press  to go back through the settings in order.

(Go back)

**3** Press  to finish.

Returns to the clock display.

**Pump operation in the Keep Warm mode**

<b>1-1</b>	Default setting when shipped
<b>1-2</b>	The interval between vacuum pump operations is longer than the default setting. <ul style="list-style-type: none"> <li>• Do not keep rice warm for more than 32 hours when using this setting.</li> </ul>
<b>1-3</b>	The vacuum pump does not operate in the Keep Warm mode. (No vacuum is created in the Keep warm mode.) <ul style="list-style-type: none"> <li>• Do not keep rice warm for more than 24 hours when using this setting.</li> </ul>

(Vacuum) is displayed for "1-1" and "1-2"

(Vacuum) is not displayed while keeping rice warm for "1-3"

(VACUUM does not) light up



# Cleaning

## Attention

Using the cooker without cleaning it may cause bad odors. Always keep it clean.

### ⚠ WARNING

**Remove any foreign objects from every part of the inner lid, clamp receiving parts, and clamp parts.**

Otherwise, the outer lid may open or steam may leak during cooking, resulting in burns.

### ⚠ CAUTION

**Before cleaning the cooker, unplug the power plug and wait until the cooker has cooled.**

Otherwise, you may get burned.

### Do not clean with the following items

(They will cause deformation, corrosion, discoloration, cracks and scratches.)

- Dishwasher / dryer
- Any other washing agent than neutral detergent for kitchen use
- Benzine, thinner, alcohol, cleanser or bleach
- Scrubbing brushes, melamine sponges, and other things that may cause scratches

\* As the steam vent cap is made of aluminum, it may change color when using dishwasher/dryer detergent.

## Remove and wash the following parts (See page 12 for the instructions on how to remove and attach parts.)

**Wash** with a sponge and neutral detergent for kitchen use

- Wash soon after use. (Otherwise it may cause bad odors.)
- After cleaning, wipe dry with a clean, dry dishcloth.

### Inner lid and filter On each use

- Immerse dirty parts in lukewarm water so that you may remove the dirt easily.

After cooking with seasonings, clean the inner lid. Otherwise, it may get rusty.

Remove foreign objects on each part shown in the figure below using a bamboo skewer or toothpick.

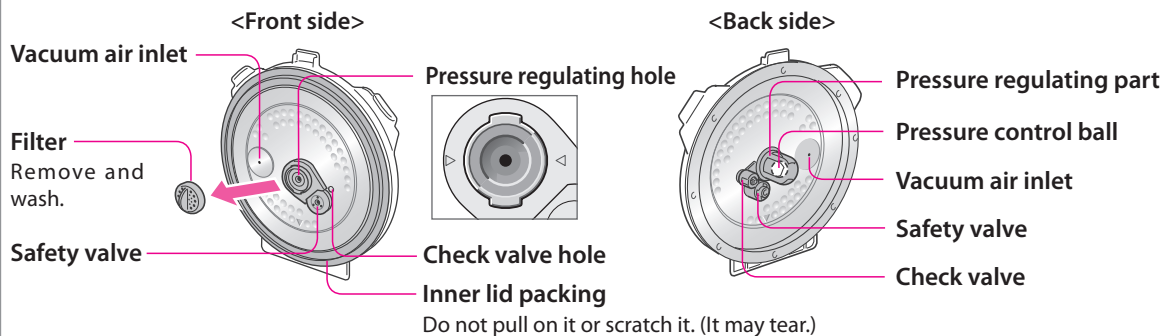

### Steam vent On each use

Wash the inside of the steam vent, and wipe it dry.

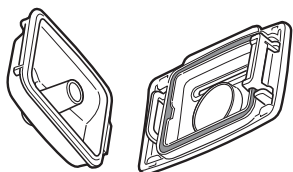

- If the steam vent is dirty, the rice may develop bad odors or boil over.
- Steam condenses and leaves water droplets in the steam vent. If this water is not wiped away, it may fall down when the outer lid is opened.

(⚠ As water inside the steam vent is hot straight after use, wait until the main body has cooled down before cleaning.)

### Inner pot, rice scoop and steaming stand On each use

### Rice scoop holder and measuring cup When dirty



## Cleaning by boiling (about once a week) You can do this when you are worried about odor.

- 1 Put water into the inner pot and close the outer lid.**  
(Up to water level scale 1 for White rice)
- 2 Select the <White / Regular> cooking course and press the START key.**  
It takes about 60 minutes to reach the Keep Warm mode. (The actual time will be longer than the displayed.)
- 3 When the cooker enters the Keep Warm mode, press the OFF key.**  
Then, when the main body becomes cool enough, clean the inner lid, steam vent, inner pot and other parts and dry them.

- Never put anything else (detergent, etc.) in the inner pot.
- Do not continuously repeat cleaning by boiling.
- Some odors may not be completely removed.

## Foreign objects, water drops, and dirt on the main body

**Wipe** with a clean, firmly-wrung cloth.

 Do not wash the main body with water, immerse it in water, or pour water over it.

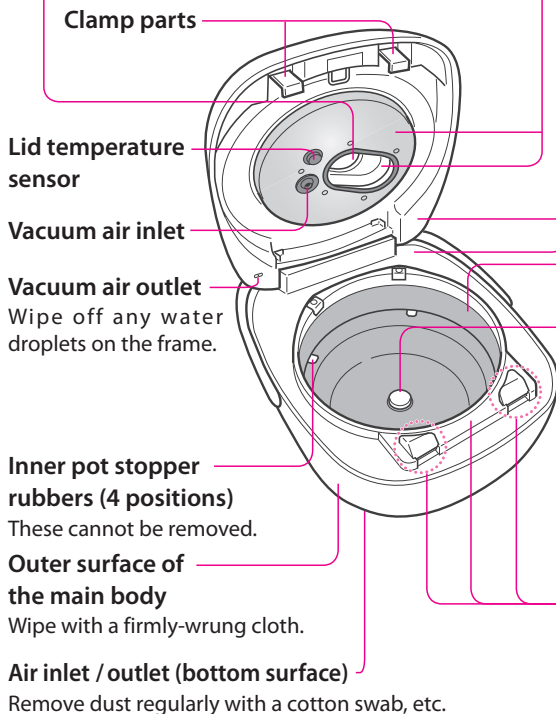
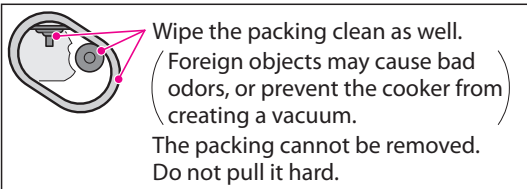

### Heating plate / steam pathway / vacuum air inlet

Wipe off water drops in the steam pathway each time. (Otherwise, they will cause bad odors.)

### Inner side of the outer lid/frame

If the outer lid is closed with foreign objects stuck to it, the outer lid will open during cooking, resulting in burns or injuries.

Wipe off fluid on the frame or seasonings stuck to it. (Contamination with seasonings may cause rust.)

### Inside the rice cooker

### Temperature sensor

### Lid temperature sensor

Using the cooker when dirty will reduce efficiency of heat transfer, resulting in poorly-cooked rice.

### When the temperature sensor is dirty

Lightly rub with a fine abrasive paper (about No. 600), and wipe off with a firmly-wrung cloth.

### Clamp parts and clamp receiving parts

If the outer lid is closed with foreign objects stuck to it, the outer lid will open during cooking, resulting in burns or injuries.

### If any rice grains, etc. have got stuck in the clamp receiving parts, remove them with a cotton swab.

- If the outer lid is closed with rice grains, etc. in the holes, the outer lid sometimes cannot be opened due to conglomeration of the rice.

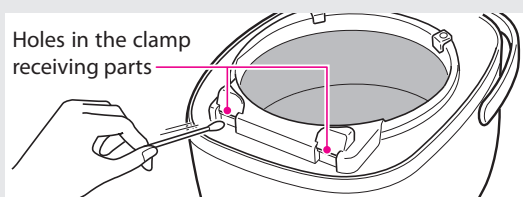

# Recipes

- Use the measuring cup provided to measure the rice. (1 cup = about 180 ml)
- 1 tablespoon (tbsp) = 15 ml, 1 teaspoon (tsp) = 5 ml

## Mixed rice with ingredients

### Ingredients

(for four people)

- Rice ..... 3 cups
  - Carrot ..... 60 g
  - Boiled bamboo shoots... 60 g
  - 2 dried shiitake mushrooms
  - Chicken breast ..... 60 g
  - Fried tofu  
..... 20 g (about 1/2 piece)
  - Sake ..... 1 tbsp
  - Salt ..... 1 tsp
  - A** Soy sauce ..... 1 tbsp
  - Japanese soup powder  
..... 1/2 tsp
- Water that the shiitake mushrooms were soaked in

- 1 Wash the rice quickly until water becomes clear, and **soak it in plenty of water for 30 minutes.**
- 2 Soak the dried shiitake mushrooms until soft, and cut them into thin strips. Pour boiling water on the fried tofu and cut it into thin strips. Cut the carrot into thin strips, the boiled bamboo shoots into thin slices, and the chicken into small pieces.
- 3 **Drain the rice in a sieve basket, and then put the rice into the inner pot. Add **A** to the inner pot, add water that the shiitake mushrooms were soaked in and fresh water up to **water level scale 3 for White rice, and mix well.****
- 4 **Place the chopped ingredients on the rice in a ring shape and close the outer lid.**

### Mixed rice

Up to 4 cups for the 1.0 L type  
Up to 6 cups for the 1.8 L type



- 5 Select the **<White / Mixed>** cooking course and press the **START** key.
- 6 When the cooker enters the Keep Warm mode, loosen the rice.



### When you add ingredients and seasonings Tips for cooking mixed rice

- **Observe the max. cooking volume.** (See page 16)
- **After washing rice, soak it in water for about 30 minutes.**  
Soak sweet rice for about 1 hour, and brown rice for about 2 hours. (Adding seasonings makes it difficult for the rice to absorb water.)
- **After soaking rice, put it in a sieve basket to drain excessive water.** Do not leave the rice in the sieve basket. (The rice tends to scorch when the starch in the rice has settled down.)
- **Add seasonings, adjust the amount of water for cooking, and then mix well from the bottom to the top.**
- **Then start the cooking without waiting too long.**  
(Tasty rice cannot be cooked if it is left uncooked for a long time because the seasonings settle down.)
- **Ingredients ...Cut the ingredients into small pieces and do not mix with the rice.**  
Place them on the rice in a ring shape.  
**...The amount of ingredients should be up to 70g per cup of rice.** (up to 30g for dried beans.)

\* White rice and pre-washed rice: **<Mixed>** course  
Brown rice, germinated brown rice, coarse cereals, congee: Select each cooking course.

**Do not use the <Quick1> or <Quick2> cooking course.**

**Do not mix greens in from the start.**

Boil the greens and add them after the rice is cooked.

(The steam vent may be blocked, causing burns.)

- Do not use the Keep Warm mode, or the timer.  
(It may cause discoloration, spoiling of the rice or corrosion of the inner pot.)
- If you use ingredients listed in commercially available recipes, or if you replace water with other liquid (e.g. tomato juice, etc.), the cooked rice may not turn out tasty.

## Sweet rice with red beans (Cooked sweet rice) →

### Sweet rice

Up to 4 cups for the 1.0 L type  
Up to 6 cups for the 1.8 L type

### Ingredients (for four people)

Sweet rice ..... 2 cups  
Rice  
(non-glutinous rice) ... 1 cup  
Cow-peas (or red beans)  
..... 50 g

\* Using only sweet rice makes the cooked rice too soft. Add 1 cup of non-glutinous rice for every 2 cups of sweet rice. The rice will not taste very good if only sweet rice is used.

Sweet rice with red beans  
(Steamed sweet rice)  
→ see page 30

- 1 Wash the rice quickly until water becomes clear, and **soak it in plenty of water for 1 hour.**
- 2 Put the cow-peas in cold water and bring it to the boil. Drain the water when it starts boiling. Add 600 ml of fresh water, bring it to a boil and then turn the heat to low. Simmer the cow-peas until they are 80 to 90% cooked. When the cow-peas are soft enough that you can press them flat between your fingers, separate the peas from the broth and leave them to cool down.
- 3 **Drain the rice in a sieve basket,** and then put the rice into the inner pot. **Add the cooled pea broth to the pot to water level scale 3 for Sweet rice,** and mix well.
- 4 **Place the boiled peas on the rice in a ring shape,** and close the outer lid.



- 5 Select the **<White / Mixed>** cooking course and press the **START** key.
- 6 When the cooker enters the Keep Warm mode, loosen the rice.

## Chicken congee

### Congee

Up to 1.5 cups for the 1.0 L type  
Up to 3 cups for the 1.8 L type

### Ingredients (for four people)

Rice ..... 1 cups  
Chicken breast... 100g  
1 thumb of ginger  
1 green onion  
Sake ..... 1 tbsp  
Water ..... 1000 ml  
Salt ..... 1/2 tsp  
Mitsuba (honeywort)  
..... as required

- 1 Wash the chicken well and place it in a pan with water, chopped green onion, grated ginger and sake. Bring the pan to a boil on a medium heat, and remove the scum on the surface to create broth. Pass it through a sieve and leave to cool.
- 2 Cut the chicken from step 1 into 1 cm cubes, and sprinkle it with salt.
- 3 Wash the rice quickly until water becomes clear, and drain it in a sieve basket.
- 4 Put the rice from step 3 and the broth from step 1 into the inner pot, and add water up to **water level scale 1 for Congee.** Stir the mixture well.
- 5 Select the **<White / Congee>** cooking course and press the **START** key.
- 6 When the cooker enters the Keep Warm mode, mix in the chicken from step 2.



- 7 Serve the food, and add mitsuba (honeywort - similar to flat leaf parsley) to decorate if desired.

# Recipes (continued)

## Sushi rice

### Sushi rice

Up to 5.5 cups for the 1.0 L type  
Up to 10 cups for the 1.8 L type

#### Ingredients

(for four people)

Rice .....	3 cups
Sweet vinegar dressing (mix beforehand)	
┌ Vinegar .....	6 tbsp
└ Sugar .....	2 1/2 tbsp
└ Salt .....	1 1/2 tsp



- 1 Wash the rice quickly until water becomes clear, add water to **water level scale 3** for **Sushi white rice**, and close the outer lid.
- 2 Select the **<White / Regular>** cooking course and press the **START** key.
- 3 Wipe a wooden sushi bowl with a washcloth soaked in vinegar water, and move the cooked rice into the bowl.

- 4 Sprinkle the sweet vinegar dressing evenly onto the rice, and mix as though you are cutting the rice.



Fan the rice while mixing to make it glossier.

\*Do not mix in the sweet vinegar dressing in the inner pot.

### Cooking Notes

- If the sweet vinegar dressing is mixed when the rice is still hot, the sweet vinegar dressing will penetrate the rice well.
- If you use a wooden sushi bowl, the bowl will absorb the excess moisture so the rice will not be glutinous.
- If you use chilled seaweed stock instead of water, the taste will be enhanced.



# Cooking in <Steam>, <Cake> and <Soup> courses

## ! WARNING

**Do not use ingredients or recipes other than those on pages 30 to 34.**

Steam or contents may come out of the cooker causing burns, injury or malfunction.

In addition, the inner pot may corrode or produce bad odors.

## Note

- The timer cannot be used.
- Use the cooking time listed on pages 30 to 34 as a guide. Final cooked state may change depending on the ingredients, room temperature, etc.
- Use plastic or wooden cooking utensils (to avoid damage to the inner pot).

## Basic operation

Detailed information on making each type of food → pages 30 to 34

Operation

### 1 Select the cooking course

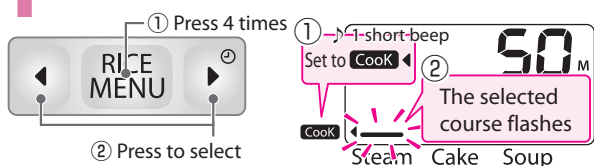

The food preparation courses stay at a constant temperature

- <Steam> ..... Approx. 100°C
- <Cake> ..... Approx. 115°C
- <Soup> ..... Approx. 90°C

### 2 Set the cooking time

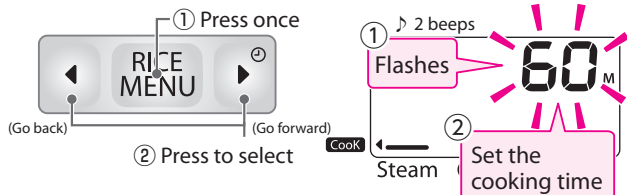

(The cooker beeps 3 times when it reaches 60 minutes.)

- The cooking time can be set in 1 minute increments up to 60 minutes.
- Press and hold the go forward and go back keys to change the time in 10 minute increments.

### 3 Press **START** Start cooking



- The actual cooking time may be longer than the set time, as it includes the time for which the temperature rises to the target temperature.

When the cooking temperature is reached, the displayed time starts to go down. (It is displayed in units of 1 minute)

Completion

**When the buzzer sounds, the cooking operation is finished. Turns off automatically**

- The inner pot is extremely hot. Take the inner pot out of the cooker using a dry oven glove, etc.
- Do not leave cooked food in the pot.
- As the cooker easily develops odors, always keep it clean. (See pages 24 and 25)

## Preparation for steaming

- Add water to water level scale 2 for "White rice".
- Place the steaming stand provided in the inner pot.
- Place ingredients to be steamed on the steaming stand, and check that you can close the outer lid without a problem.

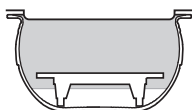

- ! Make sure that the ingredients in the inner pot do not block the steam vent at the center of the inner lid.
- ⊘ Do not put plastic wrap, aluminum foil or oven sheets into the inner pot as they may easily float.

Mastering the cooker

# Cooking in <Steam>, <Cake> and <Soup> courses (continued)

## Steam

### ⚠ WARNING

**Do not block the steam vent filter, pressure regulating part, safety valve, and check valve in the inner lid with the ingredients in the inner pot.**

(Otherwise, the cooker may boil over or you may get burned.)

**Do not put plastic wrap, aluminum foil or oven sheets into the inner pot as they may easily float.**

(Otherwise, the cooker may boil over or you may get burned.)

## Sweet rice with red beans (Steamed sweet rice) →

**Max. cooking volume**  
Up to 2 cups

### Ingredients

Sweet rice ..... 2 cups  
Cow-peas (or red beans)  
..... 30 g  
Water for sprinkling  
..... 80 ml  
(40 ml per cup of rice)



**1** Parboil the cow-peas (see step 2 in "Sweet rice with red beans (Cooked sweet rice)" on page 27). Separate the peas from the broth and leave them to cool.

**2** Wash the rice quickly until water becomes clear, soak it in water with the pea broth added for 2 hours, and then place it in a sieve basket to drain the excessive water. Keep the water used to soak the rice for sprinkling.

**3** Add water to the inner pot to **water level scale 2 for White rice**, and place a steaming cloth on the steaming stand provided in the pot.

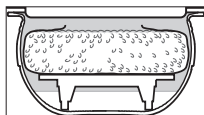

**4** Place the rice from step 2 and the peas from step 1 on the steaming cloth, mix well, level off, and make several dents on the rice surface. Make a large hollow in the center so that it does not touch the filter, and close the lid.

\* Make sure that the steaming cloth does not stick out from the outer lid.

⊘ Do not block the steam vent at the center of the inner lid with the steaming cloth.

**5** Set the cooking course and cooking time (page 29), and press the **START** key.

Cooking course	Cooking time
Steam	30 min.

**6** When the buzzer sounds, sprinkle half of the water evenly onto the rice, mix the rice and close the outer lid.

**7** Set the cooking course and cooking time (page 29), and press the **START** key.

Cooking course	Cooking time
Steam	10 min.

**8** When the buzzer sounds, sprinkle water once again and steam the rice again.  
(Repeat steps 6 and 7 again.)

**9** When the buzzer sounds, move the cooked rice to another container and loosen it.

\* If the cooked rice is hard, sprinkle more water, mix the rice, and steam it for about 10 minutes.

## Steamed gyoza (potstickers)

### Max. cooking volume

The amount in the recipe (10 pieces)

### Ingredients (for 10 pieces)

Minced pork ..... 70 g  
 A  $\left\{ \begin{array}{l} \frac{1}{3} \text{ of a green onion} \\ \text{Garlic chives ... 1 stalk} \\ \text{Garlic ... } \frac{1}{3} \text{ of a clove} \\ \text{Ginger... } \frac{1}{3} \text{ of a thumb} \\ \text{A pinch of salt} \\ \text{Soy sauce..... } \frac{2}{3} \text{ tsp} \\ \text{Sake..... } \frac{2}{3} \text{ tsp} \\ \text{Sesame oil ..... } \frac{2}{3} \text{ tsp} \end{array} \right.$   
 10 dumpling wrappers

For the seasoned agar jelly  
 B  $\left\{ \begin{array}{l} \text{Powdered agar ... 1 g} \\ \text{Water ..... 80 ml} \\ \text{Chinese soup powder} \\ \text{..... } \frac{1}{3} \text{ tsp} \end{array} \right.$

- 1 Make the seasoned agar jelly. Put the ingredients in **B** into a pan and bring to the boil while stirring constantly for 2 minutes until dissolved. Transfer into a container to solidify. When the jelly has solidified, tear it into small pieces.
- 2 Finely chop the green onion, garlic chives, garlic and ginger.
- 3 Put the mince, the jelly from step 1, and the ingredients in **A** into a bowl. Mix the contents well until a paste state is formed, and divide the mixture into 10.
- 4 Place the mixture from 3 onto a dumpling wrapper, and seal the edges of the wrapper firmly.
- 5 Add water for steaming into the pot up to **water level scale 2** for **White rice**, place the **steaming stand provided** in the pot, and cover it with cabbage or napa cabbage (not included in the ingredients list).



- 6 Place the gyoza from step 4 on the steaming stand.
- 7 Set the cooking course and cooking time (page 29), and press the **START** key.

Cooking course	Cooking time
Steam	15 min.

## Shumai (pork dumplings)

### Max. cooking volume

The amount in the recipe (10 pieces)

### Ingredients (for 10 pieces)

Minced pork ..... 100 g  
 A  $\left\{ \begin{array}{l} \text{Peeled shrimp ... 50 g} \\ \frac{1}{4} \text{ of a green onion} \\ \text{Ginger juice ..... 1 tsp} \\ \text{Soy sauce..... } \frac{2}{3} \text{ tsp} \\ \text{Sugar ..... 1 tsp} \\ \text{Sesame oil ..... 1 tsp} \\ \text{Salt ..... } \frac{1}{3} \text{ tsp} \\ \text{Potato starch ..... 2 tsp} \\ \text{A small amount of} \\ \text{pepper} \end{array} \right.$   
 10 shumai wrappers  
 10 green peas

- 1 Finely chop the peeled shrimp and green onion.
- 2 Put the mince and the ingredients in **A** into a bowl, and mix well until a paste state is formed. Divide the mixture into 10.
- 3 Make a circle with the fingers of your left hand and place a shumai wrapper on top. Place the mixture from step 2 on the wrapper and push it down using a knife or spatula so as to form a cylinder. Stick the end of the wrapper to the filling, and decorate with a green pea.
- 4 Add water for steaming into the pot up to **water level scale 2** for **White rice**, place the **steaming stand provided** in the pot, and cover it with cabbage or napa cabbage (not included in the ingredients list).
- 5 Place the shumai from step 3 on the steaming stand.



- 6 Set the cooking course and cooking time (page 29), and press the **START** key.

Cooking course	Cooking time
Steam	15 min.

# Cooking in <Steam>, <Cake> and <Soup> courses (continued)

## Cake

### Dome sponge cake

**Max. cooking volume -**  
Wheat flour - Up to 120 g  
(1.0 L/1.8 L cookers)

#### Ingredients

Wheat flour ..... 120 g  
Baking powder ..... 1/2 tsp  
4 eggs  
Granulated sugar ..... 100 g  
A few drops of vanilla essence  
Melted butter ..... 30 g  
Milk ..... 30 ml  
Apricot jam (pureed) ... 4 tbsp (80 g)  
For the icing

**A** Powder sugar ..... 50 g  
Lemon juice ..... 1 1/2 tsp



**1** Mix and sift the wheat flour and baking powder. Grease the inner pot lightly with melted butter (not in the ingredients list).

**2** Crack the eggs into a dry bowl and add the granulated sugar. Mix the eggs and the sugar lightly with a whisk, then immerse the bowl in hot water. When the egg mixture has warmed up to body temperature (about 40°C), take the bowl out of the hot water and whisk.



\* Do not beat it in the inner pot.

**3** Beat the mixture well with the whisk until it becomes white and thick, and add 2 or 3 drops of vanilla essence.



**4** Sift the flour mixture from step 1 into the egg mixture from step 3 gradually, in two or three times. Mix it quickly with a wooden spatula so that the foam bubbles may not be broken until the mixture is well mixed.



**5** Sprinkle the melted butter and the milk on the mixture from step 4, and mix it quickly so that the foam bubbles may not be broken.



**6** Pour the mixture from step 5 into the inner pot, and pat the pot once or twice to break the larger air bubbles. Put the inner pot in the cooker and close the outer lid.

**7** Set the cooking course and cooking time (page 29), and press the **START** key.

Cooking course	Cooking time
Cake	40 min.

**8** When the buzzer sounds, put a bamboo skewer into the cake to check that it is cooked through. If the skewer comes out clean the cake is cooked. If you find some dough on it, add some more time to cook the cake.

**9** Take the inner pot out of the cooker with an oven glove. Put a plate over the pot, turn the pot and plate upside down to place the cake on the plate, and leave it to cool.

**10** Apply apricot jam to the surface of the cake with a brush. Mix the ingredients in **A** to make icing, and put the icing on the cooled cake. Then let the icing dry.

#### Cooking Notes

- Before beating, wipe off any grease or water from the bowl and whisk.
- You can use an electric mixer for easy beating.
- The top of the cake will not turn brown. Turn the cake upside down before decorating.
- If the icing is too hard or soft, adjust the amount of lemon juice and powder sugar.
- You can decorate the cake with whipped cream and/or cut fruit instead of icing.



# Pineapple coconut cake

**Max. cooking volume -**  
Wheat flour - Up to 100 g

## Ingredients

- A**
- Wheat flour..... 100 g
  - Coconut flour .....2 tbsp
  - Baking powder ..... 1 1/2 tsp
  - Granulated sugar ..... 80 g
  - A pinch of salt
  - Milk ..... 70 ml
  - 2 small eggs (100 g)
  - Cooking oil .....2 tbsp
  - A few drops of vanilla oil
  - Pineapple in syrup  
(canned pineapple slices) ..... 75 g
  - Finely shredded coconut ..... 15 g
- For the topping
- Apricot jam.....1 tbsp
  - Rum ..... 2 tsp
  - Finely shredded coconut ..... 5 g
  - Pineapple in syrup  
(canned pineapple slices) ... 2 slices



- 1** Wipe excess syrup from the pineapple. Chop the slices for the cake mixture into 5 mm cubes, and cut the two slices for the topping into 8 even pieces.
- 2** Mix the dry ingredients in **A** and sift into a bowl. Add the milk, eggs and cooking oil in this order. Mix them with a whisk, then add the vanilla oil, chopped pineapple and finely shredded coconut, and mix well.
- 3** Grease the inner pot with melted butter (not in the ingredients list) and pour in the mixture from step 2.
- 4** Set the cooking course and cooking time (page 29), and press the **START** key.
- 5** When the cake is cooked, take the inner pot out of the cooker with an oven glove, etc. Spread the apricot jam and rum mixture onto the cake while it is hot. Decorate with pineapple, and sprinkle on the coconut for the topping.  
\*This moist cake is made simply by mixing the ingredients together.

Cooking course	Cooking time
Cake	45 min.

(continued)

# Cooking in <Steam>, <Cake> and <Soup> courses (continued)

## Soup

### ⚠ WARNING

**Do not put the following things in the pot.** (The mixture may cause a boil-over, or you may get burnt.)

- Fish pastes, beans, noodles, baking soda, roux (e.g. curry roux, stew roux), large amounts of oil, ingredients such as milk that will bubble up easily.
- Things that float easily to the surface such as greens, plastic wrap, aluminum foil, oven sheets and scum removing sheets.

### ⚠ CAUTION

**Make sure that the water level does not exceed the "Soup MAX" level scale when putting ingredients/seasonings/water in the pot.**

(Putting too much into the pot may cause it to boil over, causing burns.)

### Attention

- In the <Soup> course, ingredients are brought to the boil first, and then the heat is lowered. Ingredients should be added from the start.  
(Excluding greens and ingredients that cook fast.)

## White radish and pork spare rib soup

**Maximum volume**  
- up to the Soup MAX level scale

### Ingredients

Pork spare ribs ..... 80 g  
White radish ..... 160 g  
Half an onion  
Water ..... 500 ml  
A [ Salt ..... as required  
A pinch of MSG  
A small amount of  
sesame oil

**1** Cut the spare ribs into 3 cm wide pieces. Slice the white radish thinly, and finely chop the onion.

**2** Put the ingredients from step 1 in the pot, pour in 500 ml of water and close the lid.

**3** Set the cooking course and cooking time (page 29), and press the **START** key.

Cooking course	Cooking time
Soup	60 min.

**4** When the buzzer sounds, skim off any floating oil, and add the ingredients in **A**.

\* If the ingredients are not fully cooked, increase the cooking time.

## White radish, corn and pork backbone meat soup

**Maximum volume**  
- up to the Soup MAX level scale

### Ingredients

Pork backbone  
(chine) ..... 120 g  
White radish ..... 60g  
Carrot ..... 30 g  
Ear of corn ..... 30 g  
Ginger ..... as required  
Water ..... 500 ml  
A [ Salt ..... as required  
A pinch of MSG  
A few drops of vinegar

**1** Cut the backbone into 1.5 cm cubes, and cut the ear of corn into 3 cm pieces. Cut the white radish and carrot into cubes, and grate the ginger.

**2** Put the ingredients from step 1 in the pot, pour in 500 ml of water and close the lid.

**3** Set the cooking course and cooking time (page 29), and press the **START** key.

Cooking course	Cooking time
Soup	60 min.

**4** When the buzzer sounds, skim off any floating oil, and add the ingredients in **A**.

\* If the ingredients are not fully cooked, increase the cooking time.

\* After serving, add vinegar to your liking.  
(Do not pour vinegar into the inner pot.)

# Sounds

## Sounds while in use (the cooker produces sounds while operating)

- Clicking ..... the sound of vacuum pressure regulation  
Buzzing ..... the sound of electrical conduction through induction heating  
(It sometimes makes sounds in the Keep Warm mode.)  
Humming ... the sound of fan rotation to vent internal heat to the outside  
Air rushing ... the sound of steam being ejected from the steam vent.

### Sounds associated with the vacuum operations

The vacuum pump operates to create a vacuum in the cooker. It produces various sounds (clicking, buzzing, or air-rushing sound) when cooking, starting the timer and in the Keep Warm mode.

- When the open button is pressed while the **VACUUM** indication is lit, the vacuum is released, and a clicking noise can be heard.
- Bubbling sounds etc. are made when steam sucked in by the vacuum pump condenses and escapes from the pump. This is not a problem.

If the vacuum pump is too noisy



#### The vacuum pump operation settings can be changed.

- If the vacuum pump is too noisy in the Keep Warm mode ➔ page 23
- If the vacuum pump is too noisy when the timer is set ➔ page 36
- If the vacuum pump is too noisy when cooking rice (when soaking) ➔ page 36

## Beeping sounds

The beeping sounds that the cooker makes cannot be altered or muted.

# Changing the settings



■ Plug in the cooker, and change the settings with the cooker turned off.



## To stop the vacuum pump from making noise when the timer is set

Change the setting to stop the vacuum pump from operating when the timer is set. (A vacuum is not created.)

**1** Press **QUICK1** for 5 seconds  or longer.

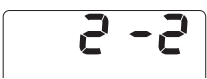
**2** Press **QUICK1** once to  change the setting to "2-0". Default setting when shipped

**3** Press  **RICE MENU**  to  (Go forward) change the setting. The vacuum pump does not operate when the timer is set.

\* Press  **RICE MENU**  to change back to the default setting when shipped. (Go back)

**4** Press  to finish. 

(Vacuum) is displayed when the timer is set for "2-1"

(Vacuum) is not displayed when a timer the set for "2-2"

(Vacuum does not light up)





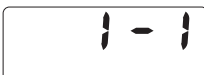

## Changing the vacuum release settings when soaking\* rice

If the sound of the vacuum releasing when soaking\* rice is too loud, change the setting from "4-1" to "4-2".

**1** Press **QUICK1** for 5 seconds  or longer.

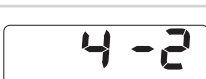
**2** Press **QUICK1** 3 times to  change the setting to "4-0". Default setting when shipped

**3** Press  **RICE MENU**  to  (Go forward) change the setting. The vacuum release setting changes.

\* Press  **RICE MENU**  to change back to the default setting when shipped. (Go back)

**4** Press  to finish. 

Change the vacuum release settings to reduce the sound of rushing air and clicking.

\* When soaking rice for the following cooking courses: <Delicious>, <Delicious Hard> and <Delicious Sticky>.

The vacuum release settings cannot be changed for other cooking courses.



## Changing the Keep Warm settings

If the rice around the inside of the inner pot becomes mushy or develops a bad odor, check the troubleshooting guide on page 38, and follow the procedure below to change the Keep Warm settings.

**1** Press **QUICK1** for 5 seconds  or longer.

**2** Press **QUICK1** twice to  change the setting to "3-0". Default setting when shipped

**3** Press  **RICE MENU**  to  (Go forward) change the setting. The setting after changing

\* Press  **RICE MENU**  to change back to the default setting when shipped. (Go back)

**4** Press  to finish. 

If no improvement is made despite following the procedure to change the Keep Warm Settings, contact the shop from which the product was purchased. (See page 43)

If the vacuum pump is too noisy in the Keep Warm mode → page 23

# Troubleshooting

Investigate the cause yourself before requesting repair. If you cannot find the cause, contact the shop from which the product was purchased. (See page 43)

Problem		Causes/what to check (reference page)
Rice	<p>...is soft</p> <p>...is mushy</p> <p>...coagulates</p> <p>...is not tasty</p>	<ul style="list-style-type: none"> <li>• <b>Reduce the amount of water, or use the &lt;Delicious Hard&gt; cooking course.</b></li> <li>• <b>Loosen the rice immediately</b> after it is cooked.</li> <li>• For recently harvested rice, cook it with a little less water.</li> <li>• Rice becomes softer when it is soaked before cooking or the timer is set for cooking.</li> <li>• Washing rice too hard or leaving it in a sieve basket for a long time will cause rice grains to crack and/or break, resulting in mushy rice.</li> <li>• Did you use alkaline water of pH 9 or greater, or hot water ?</li> </ul>
	<p>...is hard</p> <p>...dries out</p> <p>...is not tasty</p>	<ul style="list-style-type: none"> <li>• <b>Increase the amount of water, or use the &lt;Delicious Sticky&gt; cooking course.</b></li> <li>• Soak rice in water before cooking.</li> <li>• Did you use hard mineral water ?</li> </ul>
	<p>...scorches</p> <p>* Rice becoming a golden brown is not a malfunction.</p>	<p><b>In the following cases, the rice may easily be scorched.</b></p> <ul style="list-style-type: none"> <li>• When rice is not washed sufficiently.</li> <li>• When rice is soaked for a long time. When rice is cooked using the timer.</li> <li>• When pre-washed rice is cooked. Rinse rice 1 or 2 times before cooking to prevent scorching.</li> <li>• When cooking whole rice, or adding seasonings to cook mixed rice.</li> <li>• When foreign objects are attached on the temperature sensor, lid temperature sensor, etc.</li> <li>• Did you use the &lt;Mixed / Okoge&gt; cooking course ? The color of the okoge (slightly browned and crispy rice) varies depending on the quality of the rice, how the rice was washed, the amount of water and the seasonings used.</li> </ul>
	<p>...does not cook well</p> <p>...is not tasty</p>	<ul style="list-style-type: none"> <li>• Did you start cooking while the inside of the cooker or inner lid was hot? Start cooking after cooling it down to a body temperature.</li> <li>• Rice cooked in the &lt;Quick1&gt;, &lt;Quick2&gt; or &lt;eco mode&gt; course may be slightly mushy or hard. (See pages 9 and 18) Try cooking rice using the &lt;Delicious&gt; course.</li> <li>• Are any foreign objects stuck in the inner lid, or stuck on the temperature sensors (2 positions), inner lid packing, inner pot rim, or vacuum air inlet/outlet? (See page 13)</li> <li>• Has the inner pot or inner lid been deformed, or did you forget to attach the inner lid or steam vent?</li> <li>• Was there a power failure while cooking ?</li> </ul>
	<p>Mixed rice</p> <p>does not cook well</p>	<ul style="list-style-type: none"> <li>• Did you mix ingredients into the rice ?</li> <li>• For other reasons, see "When you add ingredients and seasonings". (See page 26)</li> </ul>

# Troubleshooting (continued)

Problem	Causes/what to check (reference page)
<b>Rice kept warm...</b>  ...smells bad * If the rice smells, be sure to clean the cooker by boiling before use. (See page 25)  ...dries out ...becomes discolored  ...is not hot enough  ...is mushy	<ul style="list-style-type: none"> <li>• <b>Did you do any of the following ?</b> Using the Keep Warm mode for too long, using it for mixed rice, using it for non-white rice, using it for cold rice, leaving the rice scoop in the pot, using the Keep Warm mode repeatedly for long periods of time, or keeping rice warm for over 12 hours in &lt;eco mode&gt; ?</li> <li>• <b>Are the inner lid, filter, steam vent and the main body dirty ?</b> Be sure to remove and clean the inner lid, filter and steam vent, and dry them with a clean cloth every time you cook. Also wipe off water drops in the steam pathway every time. (See pages 24 and 25)</li> <li>• Did you wash the rice sufficiently ? Did you set the timer for too long ? (See page 21)</li> <li>• Is the rice still in the pot with the Keep Warm mode off ? Did you remove and then replace the inner pot in the Keep Warm mode, press the OFF key accidentally, or lose power due to a long power failure ?</li> <li>• <b>Did you leave the rice in the pot after turning off the Keep Warm mode ?</b> <b>After checking the above, change the Keep Warm settings if necessary.</b> (See page 36)</li> </ul>
	<ul style="list-style-type: none"> <li>• Are there any foreign objects on the inner lid packing, inner pot rim, or main body frame ?</li> <li>• Are there any foreign objects on the outer side of the inner pot or the temperature sensor ?</li> <li>• Is the steam vent properly fitted ?</li> <li>• Did you use the Keep Warm mode for a long time or repeatedly reheat the rice ?</li> </ul>
	<ul style="list-style-type: none"> <li>• "Reheat" the rice before serving. (See page 23)</li> </ul>
	<ul style="list-style-type: none"> <li>• Use the Keep Warm mode after cooking rice with a little less water.</li> <li>• <b>Loosen the rice immediately</b> after it is cooked.</li> <li>• Gather the rice stuck to the side surface of the inner pot and loosen the rice occasionally.</li> <li>• If none of the above apply, but the rice around the inside of the pot is still mushy, change the Keep Warm settings. (See page 36)</li> </ul>
<b>Opening / closing the outer lid</b>  Opening the outer lid takes a longer time  The outer lid is hard to close. The outer lid does not close.  The outer lid opens during cooking.	<ul style="list-style-type: none"> <li>• As the cooker creates a vacuum, the lid seals very efficiently, and it takes some time for the lid to open after the open button is pressed. Especially, when the main body is warm, e.g. in the Keep Warm mode, it may take longer to open the outer lid than when it is cool.</li> </ul>
	<ul style="list-style-type: none"> <li>• As the cooker creates a vacuum, the sealing performance of the lid is high, and you may feel it is difficult to close the lid. Especially, when the main body is warm, e.g. in the Keep Warm mode, you may find it more difficult to close the outer lid than when it is cool. Push the center of the outer lid front part until it clicks.</li> <li>• Is the inner lid in place ? The outer lid cannot be closed when the inner lid is not attached to.</li> <li>• Are the insertion parts of the inner lid properly fitted in place (2 positions)? (See page 12)</li> <li>• Are there any foreign objects on the clamp receiving parts or clamp parts ? (See page 25)</li> <li>• Are any foreign objects stuck in the inner lid ? (See page 24)</li> <li>• Close the lid, then press the <b>START</b> key. (See page 14)</li> </ul>
	<ul style="list-style-type: none"> <li>• Push the center of the outer lid front part until it clicks.</li> <li>• Are there any foreign objects on the clamp receiving parts or clamp parts ? (See page 25)</li> <li>• Close the lid, then press the <b>START</b> key. (See page 14)</li> </ul>

Problem	Causes/what to check (reference page)
<b>Opening/closing the outer lid</b> <b>The lid does not open when the open button is pressed.</b>	<ul style="list-style-type: none"> <li>You cannot open the lid by pressing the open button during cooking. (To open the outer lid during cooking, see page 10.)</li> <li>When the <b>VACUUM</b> indication is lit in the Keep Warm mode, press the open button twice: Once to release the vacuum, and the second time to open the lid. (See page 10)</li> <li><b>When the open button is too heavy to be pressed down in order to open the outer lid, pressure may be being applied to the inner pot and it is dangerous to open the outer lid. For your safety, instead of forcibly pressing the open button to open the outer lid, press the OFF key and wait until the main body has cooled down and the pressure is reduced. (It takes about 40 minutes.)</b> After opening the outer lid, remove foreign objects in the inner lid, clamp receiving parts and clamp parts. (See pages 24 and 25)</li> </ul>
<b>Timer setting</b> <b>Cooking starts immediately after setting the timer.</b> <b>Cooking does not finish at the preset time.</b> <b>The timer cannot be set.</b>	<ul style="list-style-type: none"> <li>For a timer setting between 1 and 2 hours, cooking starts on the spot.</li> <li>Did you misread the clock? The cooker uses a 24-hour clock.</li> <li>Is the current time wrong ?</li> <li>Has the lithium battery burnt out ? (See page 42)</li> <li>The actual time for finishing the cooking may be delayed by about 10minutes when the room temperature or water temperature is low, or when the amount of water in the pot is increased.</li> <li>Was the inner pot in place when you tried to set the timer ?</li> <li>Did you forget to set the timer or press the <b>START</b> key after setting the timer ?</li> </ul>
<b>Cooking / keeping warm</b> <b>A thin film is formed on the inner pot.</b>	<ul style="list-style-type: none"> <li>Thin films like wafer paper are dried starch in the rice. This is not a problem.</li> </ul>
<b>The center of the rice has hollowed out.</b>	<ul style="list-style-type: none"> <li>This is caused by the inner pot heating itself in the unique IH cooking system. Loosen the rice in whole.</li> <li>When the filter is not attached, the center part of the cooked rice may become hollowed out.</li> </ul>
<b>Steam leaks out of the cooker</b> * Check the reason after cooking is finished.	<ul style="list-style-type: none"> <li>Are there any foreign objects on the inner lid packing, inner pot rim, or on the frame ? (See page 13)</li> <li>Are there any foreign objects on the inner lid, clamp receiving parts or clamp parts ? (See pages 24 and 25)</li> <li>Has the inner lid packing been damaged, or has the inner lid or inner pot become deformed ?</li> <li>Is the inner lid properly fitted? (See page 12)</li> </ul>
<b>There are water droplets near the steam vent</b>	<ul style="list-style-type: none"> <li>Water drops may form when the steam cools. This is not a problem.</li> </ul>
<b>The cooker... ...boils over ...spatters</b>	<ul style="list-style-type: none"> <li>Steam or droplets come out from the steam vent to release the pressure. This is not a malfunction.</li> <li>Was the amount of rice too small? Was the water in excess ? Did you wash the rice sufficiently ?</li> <li>Did you select the correct course when cooking congee or brown rice ? (See page 16)</li> <li>Are there any foreign objects on the temperature sensors (2 positions) ?</li> <li>Is the inside of the steam vent dirty ?</li> <li>Have you attached the steam vent, inner lid and filter ?</li> <li>Are any foreign objects stuck in the inner lid? (See page 24)</li> <li>If there is a power failure during cooking, boiling over may occur.</li> </ul>
<b>There are water droplets on the inner lid or inner pot.</b>	<ul style="list-style-type: none"> <li>Water droplets may form on the inner lid or inner pot to prevent the rice from drying out. This is not a problem.</li> </ul>
<b>Rice grains become attached to the inner surface of the inner pot and / or the inner lid</b>	<ul style="list-style-type: none"> <li>When the filter is not attached, rice grains may scatter when the vacuum pressure is released.</li> </ul>

# Troubleshooting (continued)

Problem	Causes/what to check (reference page)
<b>Cooking / keeping warm</b> When the outer lid is opened, water drips from the packing, etc.	<ul style="list-style-type: none"> <li>• Water may drip onto the frame, etc., depending on the timing of opening the outer lid, the room temperature, and so on. Wipe it off.</li> <li>• Are there any foreign objects on the temperature sensors or the outer surface of the inner pot ?</li> </ul>
<b>Cooking</b> Cooking takes a longer time. The displayed time does not change. The timer cannot be set. The cooked food does not turn out tasty.	<ul style="list-style-type: none"> <li>• The preset clock will start changing when the temperature for cooking is reached. The actual time period required to finish cooking will be longer as it includes the time during which the temperature increases to the target temperature.</li> </ul>
	<ul style="list-style-type: none"> <li>• The timer cannot be set for &lt;Steam&gt;, &lt;Cake&gt; and &lt;Soup&gt; courses.</li> </ul>
	<ul style="list-style-type: none"> <li>• Doneness varies depending on the kinds of ingredients and how they have been measured. Check the recipe or change the setting time.</li> <li>• In the following cases, the cooked food may not turn out tasty. The outer lid is not fully closed, or steam is leaking (Page 39), there are foreign objects on one of the two temperature sensors (2 positions); the inner pot is deformed; cooked food was left in the inner pot; or there was a power failure. (See page 42)</li> </ul>
<b>Display / keys</b> The lamps are off. Cooking is stopped halfway. Key operation is not possible. "1-1" is displayed when the QUICK1 key is pressed.	<ul style="list-style-type: none"> <li>• If you remove the inner pot during use, power will be cut off.</li> <li>• If you press the OFF key accidentally, or there is a long-time power failure, the power will be cut off.</li> <li>• See page 11 for information about the <b>VACUUM</b> indication. See page 22 for information about the <b>VACUUM</b> indication in the Keep Warm mode.</li> <li>• Did you touch the open button, or open the outer lid, when the <b>VACUUM</b> indication was lit? The timer will continue / the rice will be kept warm after the vacuum is released. (See page 11)</li> <li>• If the rice cooker stops operating after 4 short beeps without any error display, please contact the store from which the product was purchased.</li> </ul>
	<ul style="list-style-type: none"> <li>• Is the power plug connected? Is the inner pot in place ?</li> <li>• Is an error message, e.g. "C10", "F01", etc. being displayed? (See page 41)</li> </ul>
	<ul style="list-style-type: none"> <li>• When the QUICK1 key is pressed for 5 seconds or longer, the "1-1" display for changing the settings appears. Press the OFF key and start the procedure from the beginning. (See page 23)</li> </ul>
<b>Display</b> Display of remaining time is different from the actual cooking time. The <b>Pressure</b> indication is flashing The Vacuum indication does not light up. (No vacuum is created) The Vacuum indication has turned off. (The vacuum has been released) The elapsed time displayed in the Keep Warm mode is flashing. COO, FOO, etc. is displayed The display disappears. The time display 0:00 is flashing.	<ul style="list-style-type: none"> <li>• The actual cooking time may differ from the displayed time. This is not a malfunction. See "Cooking time display" on page 11 for details.</li> </ul>
	<ul style="list-style-type: none"> <li>• <b>Do not open the outer lid while the <b>Pressure</b> indication is flashing.</b> Pressure is applied in the inner pot. It is dangerous to open the outer lid. If the OFF key is pressed, the plug is unplugged, or due to similar power failure situations during pressure cooking, the <b>Pressure</b> indication flashes.</li> </ul>
	<ul style="list-style-type: none"> <li>• See page 11 for information about the Vacuum indication during cooking and when the timers is set.</li> <li>• See page 22 for information about the Vacuum indication in the Keep Warm mode.</li> <li>• If the timer is set in the &lt;eco mode&gt; cooking course, no vacuum will be created or in the Keep Warm mode.</li> <li>• Did you press the open button or open the outer lid? (See page 11)</li> <li>• Did you change the vacuum pump operation settings? (See pages 23 and 36)</li> </ul>
	<ul style="list-style-type: none"> <li>• This is to notify you that rice is being kept in the Keep Warm mode for too long. Stop the Keep Warm mode. (See page 22)</li> </ul>
	<ul style="list-style-type: none"> <li>• See "Error Display" on page 41.</li> </ul>
	<ul style="list-style-type: none"> <li>• The lithium battery fixed on the inside of the main body has burnt out. (See page 42)</li> </ul>



Problem		Causes/what to check (reference page)
Other problems	The cooker makes noises while in use.	• See "Sounds while in use" on page 35.
	There is a smell of plastic, etc.	• The cooker may smell at first, but the smell will decrease with use. → If you are worried about the smell, ventilate the room or clean the cooker by boiling. (See page 25)
	There is a gap between the outer lid and the main body	• There is a gap between the outer lid and the main body but it is sealed with the inner lid packing. Although the gap may be widened due to application of pressure during cooking, it is not a problem.
	The coating on the outer surface of the inner pot is scratched or dirty	• The coated outer surface of the inner pot may become scratched or dirty with use. You can use the cooker to cook rice and keep it warm without any problems.
	Sparks come out of the power plug	• Small sparks are sometimes generated when plugging or unplugging the power plug. This is inherent to the IH (induction heating) method and is not a malfunction.
	The circuit breaker is tripped during cooking.	• If you use the cooker together with other electrical appliances at the same time, electricity use may exceed the rating and trip the breaker. Do not share the electrical outlet used for the cooker with other appliances.

## Error display

Press the **OFF** key and unplug the power plug (power supply side) from the electrical outlet, and take the following action.

<b>E 10</b>	<ul style="list-style-type: none"> <li>• Remove dust from the air inlet/outlet at the bottom part of the main body.</li> <li>• Do not use the rice cooker when placed on a soft surface such as paper, cloth, carpet, plastic bags etc., or in a place where the air inlet/outlet is blocked.</li> </ul>	<p style="text-align: center;"><b>Resetting the display</b></p> <p>After taking the recommended action, plug in the power plug, then press  (Error display is reset)</p> <p style="text-align: center;">↓</p> <p>Resume the operation after cooling down the inside of the body, inner pot and inner lid to body temperature.</p>
<b>E 11</b>	<ul style="list-style-type: none"> <li>• Remove foreign objects such as rice grains adhered to the outer bottom part of the inner pot and the pot temperature sensor.</li> <li>• Has too much water been added? (Reduce the amount of water)</li> <li>• Are you using the same outlet together with another appliance? → Use a 220 V AC outlet with a rating of 10 A or more. Do not share the outlet with other appliances.</li> </ul>	
<b>E 14</b>	<ul style="list-style-type: none"> <li>• This error is displayed so that the parts may not be damaged by high voltage.</li> </ul>	
<b>F 01 to F 13</b>		<ul style="list-style-type: none"> <li>• These displays indicate malfunctions of the PCB, temperature sensor, etc. → Contact the store from which the product was purchased.</li> </ul>

## If the filter is damaged / lost

Please contact the store from which the product was purchased or any distributor listed in "东芝小家电产品全国指定特约维修网点名录" enclosed in the packing box.

The filter prevents foreign objects from becoming stuck in the pressure regulating part. Be sure to attach the filter.



The rice cooker can be used without the filter, but do not use it to cook mixed rice or rice with mixed grains, do not or use the <Quick1> and <Quick2> cooking courses, as the inner lid can easily become blocked.

## Contact the store from which the product was purchased in the following cases.

- When you put rice or water directly into the cooker instead of the inner pot.
- When the inner pot, filter, inner lid, steam vent seal packing or power cord becomes damaged or destroyed.
- When any plastic parts or packing becomes damaged. (They may become damaged after several years of use.)

## When a power failure occurs

After recovering from a power failure, the cooker will resume cooking rice or keeping it warm.

However, the cooked rice may not be tasty, the power may be cut off, or the preset finishing time may be delayed.

\*The same phenomena occur when you unplug the power plug or the circuit breaker is tripped.



If the power is cut off due to a power failure during pressure cooking, watch for steam that may be expelled from the steam vent.



While the **Pressure** indication is flashing, pressure is applied in the inner pot. Do not open the outer lid. Even when the **Pressure** indication is not displayed, do not forcibly open the outer lid if you feel it hard to press the open button.

## Lithium battery

The lithium battery attached to the main body is used to work the clock when the power plug is unplugged, and memorize cooking courses.

### If the lithium battery is exhausted

When the power plug is unplugged, timer settings and memorized cooking courses are cleared.

**To use the rice cooker, plug it in, and press the OFF key to stop the 0:00 display from flashing. The cooker can then be used normally.**

(Be sure to set the current time before using the timer.)

➔ **To replace the battery, contact the store from which the product was purchased. (Cost borne by user).**

The lithium battery is attached to the inside of the main body. Do not disassemble the main body.

You cannot replace it by yourself.

# Specifications

Model No.	RC-DX10H RC-DX10HA	RC-DX18H RC-DX18HA
Type	Rice cooker with keep-warm function	
Power supply	220 V AC, 50-60 Hz	
Rated power consumption (Cook)	1420 W	1420 W
Rated power consumption (Keep Warm)	Average 31 W*	Average 42 W*

Model No.	RC-DX10H RC-DX10HA	RC-DX18H RC-DX18HA	
Dimensions	Width	27.0 cm	29.7 cm
	Depth	36.0 cm	38.7 cm
	Height	24.4 cm	28.2 cm
Mass	6.5 kg	8.0 kg	
Length of cord	1.2 m	1.2 m	

\* Power consumption per hour in the Keep Warm mode.

(Conditions: maximum amount of rice; at a room temperature of 23°C; and with application of 220V.)

- See page 16 and pages 26 to 28 for cooking capacity.
- See the pages listed below for information on preparing food.
  - <Steam>: pages 30 and 31
  - <Cake>: pages 32 and 33
  - <Soup>: page 34
- This product is not intended to be used at altitudes of over 2000 m.

## Warranty (Attachment)

- A warranty is attached to this product.
- Please get the warranty from your dealer and make sure that the purchase date, dealer's name and other information is written on the warranty. Read the warranty thoroughly and keep it handy.
- This product is guaranteed for six months from the day of purchase. See the warranty for details.

## Repair service

Please contact the store from which the product was purchased for any questions or service.

If you have any questions or requests in China, please contact any distributor listed in " 东芝小家电产品全国指定特约维修网点名录 ".

Based on the Warranty, your product is repaired free of charge during the warranty period.

Any repair service will be for charge after the warranty period.

All the costs of shipping, packing, parts and repair of the service are the responsibility of the customer.

 <p><b>Regular check up</b></p>	<p><b>Inspect the Rice Cooker you have been using for a long time!</b></p>	<p>Please check "Instructions for safety" and "Attention" regularly when using the cooker. Parts may deteriorate with heating, humidity, dust, etc. due to improper use or long-term use of the Rice Cooker, resulting in damage or accidents.</p>
	<p>Does your cooker have any of following problems?</p> <p>Remove dust accumulated on the power plug and the outlet.</p>	<ul style="list-style-type: none"> <li>• The power plug or cord becomes abnormally hot.</li> <li>• The main body smells burnt.</li> <li>• The main body has a crack, looseness or rattling.</li> <li>• The inner pot, outer lid or inner lid is deformed or damaged.</li> <li>• The bottom fan does not run during cooking.</li> <li>• Other abnormalities or failures are observed.</li> </ul>



**TOSHIBA HOME TECHNOLOGY CORPORATION**

2570-1 Urasuda, Kamo, Niigata, 〒959-1393