

TOSHIBA

適合家庭使用

東芝電飯煲 使用說明書

型號

RC-10DRNH
RC-18DRNH
RC-10DHNH
RC-18DHNH

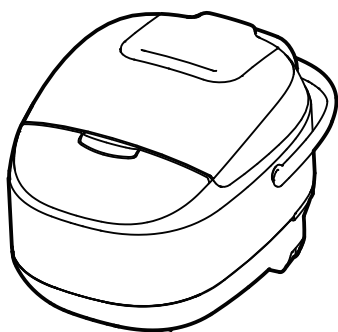

感謝您購買東芝電飯煲。

- 出於自身安全考慮，請閱讀說明書並正確使用。

使用之前請閱讀“安全注意事項”，並且“請遵循說明要求”。（第2頁-第4頁）

- 閱讀後，請將本說明書妥善放置在用戶便於獲取和查閱的地方。

目錄

使用前注意事項	安全事項.....	2
	請按照說明要求操作.....	4
	零部件介紹.....	5
煮飯	煮飯的基本步驟.....	6
	如何煮出美味的米飯.....	7
	煮飯過程.....	8
	烹煮量和烹煮時間標準.....	8
	顯示烹煮時間.....	8
	定時設置.....	9
	時間調整.....	9
“保溫”.....	10	
使用規範	食材製備方法.....	11
	• 如何使用蒸籠應用“蒸煮”功能.....	12
	• 蛋糕、鍋巴.....	13
	• 壽司.....	14
	• 湯、粥.....	15
清洗&保養/規格	清洗&保養.....	16
	• 活動蓋板、蒸汽閥的取放方法.....	16
	• 煮沸清洗.....	16
	故障情況.....	17
	• 電源故障.....	19
	錯誤提示.....	20
規格.....	20	

安全事項

出於自身安全考慮，請遵守說明要求

■ 本檔旨在解釋違反說明要求可能導致的傷害程度。

 **警告** 造成“嚴重傷害”或“死亡”的可能原因

 **提醒** 造成“身體傷害”或“財產損失”的可能原因









■ 本說明將分章節進行詳細說明。

 “禁止”情況

 “觀察”情況

 “注意”事項

 **警告** 防止電飯煲引發火災、燒傷、觸電、漏電、短路

-  避免沾濕連接器。
-  請照看兒童，確保他們不會把玩電器。
-  使用後請勿觸碰產品的發熱表面，以免燙傷。
-  在缺乏負責其安全的人士監督或指導之下，身體感到不適、精神狀態不佳或缺乏相關經驗與知識的人士（包括兒童），均不適宜使用本產品。不可在戶外使用本產品。
-  請勿靠近熱敏窗簾的地方。
-  本產品供家居及類似環境使用，如：
 - 店鋪內的員工廚房區域、辦公室及其他工作環境；
 - 農舍；
 - 供客戶於酒店、汽車旅館及其他住宅類型環境；
 - 床及早餐類型環境。
-  如果電源線損壞，必須使用售後服務中心或製造商提供的專用電源線。
-  在清潔，保養，移動或不使用時，請斷電並拔下插頭。

-  如果發現異常/故障，請立即停止使用。

請立即拔下插頭，聯繫產品銷售商家或東芝服務中心進行檢修。

《異常/故障案例》



 - 電源插頭/電源線異常發熱。
 - 電飯煲散發出燒焦的氣味。
 - 電飯煲部分破裂、鬆動、搖晃。
 - 內鍋、面蓋、活動蓋板破裂或變形。
 - 電熱盤彎曲。
-  請勿擅自拆卸、維修或改裝電飯煲。

請聯繫購買本品的實體店或東芝服務中心進行維修。





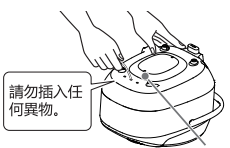

-  請勿將任何異物插入通風口底部的通氣孔或空隙。

尤其是金屬製品，例如：大頭針、電線等

-  請勿將電飯煲主體、電源插頭和電源線浸入水中或將水倒在上面。

器具不得浸入水中。

-  不要將其放置在與水接觸的位置。請勿讓不熟悉該電飯煲的人員獨自使用。請勿在兒童可觸及的位置使用電飯煲，尤其在烹煮過程中以及在烹煮完成之後應留意兒童，防止其接近電飯煲而造成傷害。
-  在烹煮過程中，請勿打開上蓋或移動/搬運電飯煲。

正確使用電源插頭/電源線。



- 使用獨立的220-240V直流插座。該電飯煲與其他電器一起使用會導致過熱，引發火災危險。請勿將本產品連接至本說明書規定之外的電源。
- 如果需要延長線，請單獨使用。
- 將插頭完全插入插座。
- 定期清除電源插頭上的灰塵。受潮積灰將導致絕緣失效，引發火災危險。用乾布擦去灰塵。
- 確保電飯煲插頭尖端上無金屬物品或垃圾（例如：大頭針等）



- 請勿讓兒童拍打插頭。請注意不要讓兒童拍打插頭。
- 在拔出插座中的電源插頭時，請握住電源插頭。否則，觸電、短路等可能引起火災。將電源插頭插入電源插座，直至電源插頭完全插入底座。
- 不使用時務必拔下電源插頭。否則，絕緣劣化可能會導致觸電、漏電、火災等。抓住插頭並將其從插座中拔出。（在拔電源線時請勿握住電源線）



警告

誤用可能導致潛在傷害

※ 說明書中的插圖如與實物有差異，請以實物為準。



警告

防止電飯煲引發火災、燒傷、觸電、漏電、短路等

正確使用電源插頭/電源線。（續）



- 請勿使用損壞的電源線/電源插頭或者鬆動的插頭等。
- 請勿讓蒸氣接觸到電源插頭或其他電器。在使用任何廚房儲物架時都要特別小心。
- 請勿使用除電鍋標配之外的任何電源線，也不要將電飯煲的電源線用於其他電器。
- 請勿將電源插頭或電源線放在高溫、浸水和潮濕的地方，也不要接觸到利器。

如果電源軟線損壞，必須用專用軟線或從其製造商或維修部買到的專用元件來更換。



- 小心處理電源線。不要以不自然的方式拉扯、卷起、扭曲、彎曲電源線，也不要盤繞時接通電源。不要在上面放置重物。不要以任何方式改裝電源線或使電源線變形。



- 請勿用濕手插拔電源插頭或電飯煲插頭。在接觸電源插頭之前，確保雙手乾燥。

請勿用濕手觸摸該產品、電源線或電源插頭。如果電源線、電源插頭損壞，或電源插頭的插入方式不正確，請勿操作本產品。



蒸氣口溫度高。臉部或雙手遠離蒸氣口。

尤其注意嬰兒和兒童，避免他們碰觸蒸氣口。



確保安裝蒸氣閥
警告：誤用會致潛在的傷害。



請勿將電飯煲用作說明書規定之外的用途。

因為這樣做可能導致鍋內的食物或蒸氣溢出或爆炸，導致燒傷/受傷。

<錯誤烹煮方式示例>

- 放置可能阻塞蒸氣口的材料，例如：菜單、鋁箔紙、除城片、食品包裝或青菜、番茄、豆類等薄片類配料。
- 烹煮容易溢出的食物，例如：果醬、豆類等時。
- 將配料放入塑膠袋在電飯煲中加熱。



提醒

避免漏電、觸電、人身傷害、燒傷、火災危險和財產損失。

防止沸騰或溢出



- 煮粥需要多加水，請勿使用“CONGEE”以外的菜單製作米粥。



- 注水量不得超過標注水位線。該標準的允許值與標注水位線的誤差不超過2毫米。

防止燒傷/受傷。



- 在使用過程中或剛使用後，請勿觸摸高溫部件，包括活動蓋板、電熱盤、內鍋、蒸氣閥鍋等。
- 不使用時，請勿按“COOK”鍵或“CANCEL/KEEP WARM”鍵。
- 因為發熱盤、內鍋外鍋和上蓋高溫。
- 在移動產品時，請勿觸摸開蓋按鈕。
- 請勿握住提手搖晃電飯煲。
- 烹煮時，不要使提手豎立。
- 請勿乾燒電飯煲。因為這樣做可能導致過熱、故障和失靈。



- 進行維護或修理時，請拔下電源，等待電飯煲冷卻。蒸氣閥可能會積聚熱水。
- 烹煮後，在打開上蓋時應小心蒸氣以及留下的熱水滴。
- 首先按“CANCEL/KEEP WARM”鍵，然後再取出內鍋。在烹煮或加熱過程中取出內鍋，不會自動斷電。
- 請使用乾抹布、佩戴烘焙手套等取出高溫內鍋。

(續)

安全事項

自身安全考慮，請遵守說明要求



提醒

避免漏電、觸電、人身傷害、燒傷、火災危險和財產損失。

請勿在以下地方使用電飯煲



- 靠近明火的區域、潮濕區域或高溫高濕區域。另外，還應注意配件和附件。
- 不平坦的地方或在熱敏墊上。它們可能會導致燒傷，引發火災危險。
- 在可能堵塞通氣孔的材料上，例如：紙、布、毯子等
- 無法完全打開蓋子的地方。它可能會導致燒傷、損壞。
- 高電磁區域。
- 靠近牆壁、傢俱等的地方
將電飯煲放在廚房儲物架上時，注意不要阻礙蒸氣的釋放。
- 荷載強度不足的滑台。荷載強度標準：
1.8L型：12 kg 及以上 1.0L型：10 kg 及以上

為安全使用



- 請勿使用除電飯煲專用內鍋之外的其他配件。
- 請勿在產品附近或產品中存放任何易燃物品、危險物品、化學品或易燃氣體。
- 使用本產品前，請仔細閱讀使用說明書。
- 使用前請務必按照說明書中的建議檢查產品是否處於良好工作狀態。
- 清除所有包裝材料。

請按照說明要求操作

若要防止故障、失靈等

請勿在以下地方使用電飯煲。
它們可能會導致故障、變形、變色等。

- 暴露在陽光直射下的地方
- 濺油的地方

不要在蓋子上蓋上任何抹布，特別是在蒸氣口上。
因為蒸氣的釋放可能因此受到限制，從而導致蓋子、蒸氣口和操作部件發生故障、變形、變色等。

保持電飯煲和周圍環境清潔，隨時可用。
灰塵、蟲子等進入功能部件內部（例如：通風口）會導致電飯煲故障。

請勿以下列方式使用電飯煲，以防止內鍋塗層刮花並脫落

- 請勿將餐具放入內鍋中，或用來洗碗。
- 請勿使用擦洗刷或洗碗機清洗內鍋。
- 請勿使用任何清潔劑、漂白劑清洗內鍋。
(使用廚房專用中性洗滌劑。)

使用後，內鍋表面的顏色可能變得不均勻，但是不會影響健康。請勿擔心。

※ 內鍋外表面上的有色塗層刮花不影響烹煮和保溫效果。

當使用內鍋淘米時，在鍋底墊一塊抹布可以使內鍋底部的外表面不易刮花。

擦去水滴或異物。

如果在未清除異物的情況下使用，例如，有異物粘在電熱盤、溫度感測器、內鍋外部等處，米飯會無法煮熟，導致故障。

不要在煤氣灶、間接加熱烹煮電器、微波爐中使用內鍋。
因為它們可能會導致內鍋變形、變色、故障等。

如果電飯煲鬆動、破裂、跌落，請停止使用。
請聯繫購買本品的實體店進行檢修。

- 調味米和添加多種配料的大米不能保溫。
(請在使用調味料後立即清洗。)
- 請勿使用醋。
- 請勿用勺子刮擦或用篩子敲打。
- 請勿使用金屬勺或攪拌器。

零部件介紹

- 首次使用時，請清洗內鍋、活動蓋板、蒸氣閥、其它部件及附件（見第16頁）。
- 首次使用時，可能會產生塑膠等氣味。使用後氣味消失。

主體

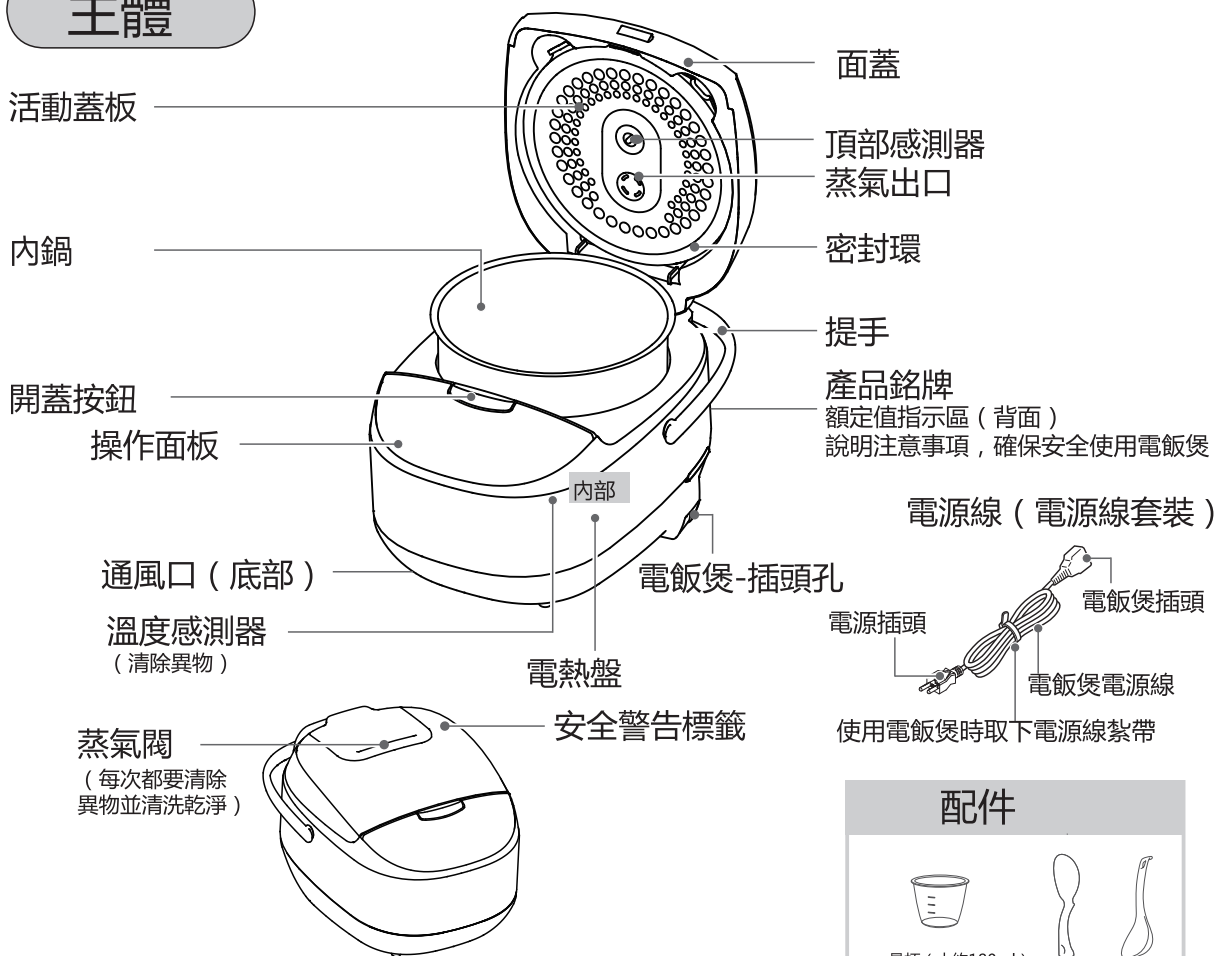

配件



操作面板

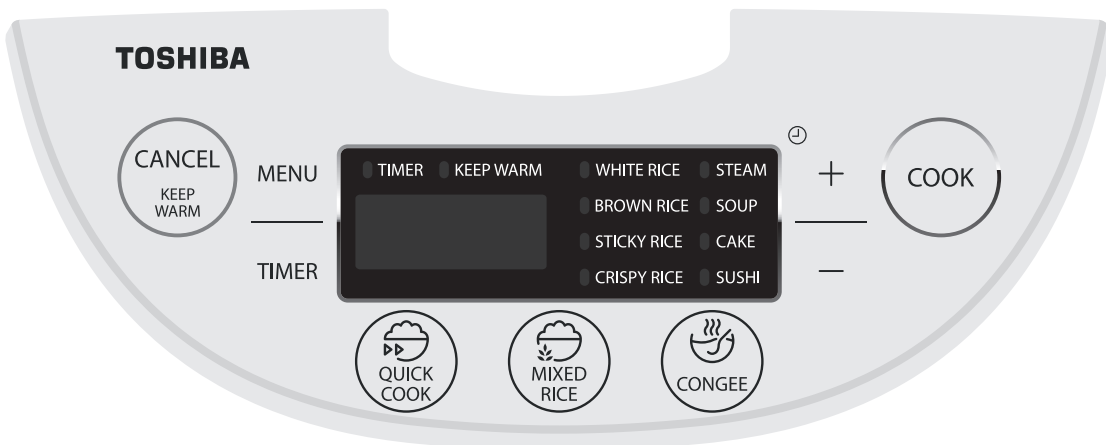

煮飯的基本步驟

製備

基本步驟

1

量米

使用提供的量杯。

一平杯=180ml

【正確用法】



【錯誤用法】

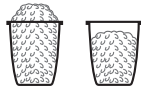

- 該量杯的容量可能與其他食品量杯（200ml）或其他大米測量容器不同。

2

淘米。

快速淘洗大米，直到水流清澈。

① 加入大量的水，（用一隻手）快速輕柔地攪拌米粒，然後立即倒出水。

② 多次淘洗大米，直到水流清澈。

- 如果在內鍋中淘米，請勿使用任何攪拌器。

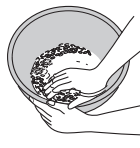

可使用內鍋淘米

3

調整水位。

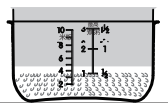
根據量杯的尺寸和數量選擇水位刻度。

在平坦的地方把米均勻地放在內鍋裡。

- 請根據您的口味調整水位。

❗標準：按照指示的水位刻度調整，誤差不超過2mm

4

擦去水滴、異物，放入內鍋，然後蓋上蓋子。

如果在以下部件上殘留水滴或異物，請擦拭乾淨。

- 殘留的水滴或異物可能導致蒸氣洩漏，使蓋子無法完全閉合，影響米飯烹煮效果。

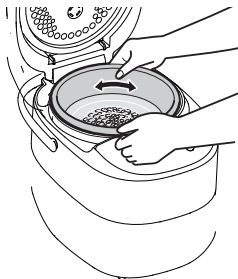

將內鍋平放在電飯煲內部的最底部（不向任何一側傾斜）。

按箭頭所示方向轉動內鍋2-3次，使其與烹煮加熱器緊密接觸。

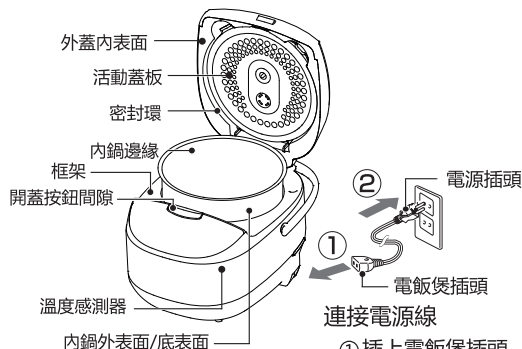

連接電源線

- ① 插上電飯煲插頭
- ② 插上電源插頭

5

設置啟動功能表，確定，並開始烹煮。



按下“COOK”鍵。

- 無需浸泡大米。
- 請勿忘記蓋上蓋子並安裝蒸氣閥。

如果蜂鳴器響起，則表示米飯已煮熟。

“KEEP WARM”指示燈亮起。

▶ 使用後，按“CANCEL / KEEP WARM”鍵並拔下電源插座上的插頭。

❗ 在取出內鍋之前，請按“CANCEL / KEEP WARM”鍵切斷電源。

※ 在米飯保溫時，即使取出內鍋，電飯煲也不會自動停止運作。

- 在“保溫後立即烹煮”或“連續烹煮”情況下，請等到電飯煲內部的溫度已經冷卻到人體常溫。

煮飯的基本步驟

如何煮出美味的米飯



準確測量米量（不超過上限）。



請勿搖晃量杯

如果搖晃量杯，米量會增加很多。

電飯煲標配量杯

請勿使用熱水淘米 淘米時間不宜過長

熱水淘米或淘米過慢會導致米糠產生異味。

淘米要輕柔，以免碾碎米粒。 輕輕搓洗米粒。

（碾碎的米粒在煮熟後會變成糊狀，黏稠。）

根據喜好調整水位。

如果喜歡較硬的米飯	將水位降低至指定的水位以下
如果喜歡軟糯的米飯	將水位升高至指定的水位以上

新產大米	水位略低於指定的水位
全米	根據指定的水位
陳米 從雨季到夏季的稻米 小麥	略高於指定的水位

各種大米的狀況和品質都不同，具體取決於品牌、產地、儲存條件。

因此請根據您的喜好進行調整。

烹煮完成後，用勺子充分打散煮好的米飯。

請用乾布或手套握住內鍋，將米飯打散，防止米飯結塊或粘連。

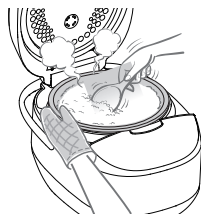

“保溫”時間不應過長。

對於“調味米和帶配料的米飯”，若剩餘少量米飯或需要長時間保溫的情況下，建議用塑膠包裝進行包裝後放在冰箱中。

米飯

- 根據生產日期購買適量新產大米，在2周-1個月內食用完。
- 將大米放入密閉的容器中，存放在陰涼處，避免氧化。

淘米完成後， 不要將大米留在漏勺中。

請勿將米飯放在漏勺中。



米粒可能會破裂，導致烹煮時變成黏糊狀。

不適合煮飯的水

硬礦泉水



pH9以上的離子水

（導致米飯變硬變乾的原因）（糊狀和粘稠原因）

煮飯用水不應超過30°C。

建議夏季使用冷水進行預設烹煮。

夏季使用冷水



（水溫過高會導致米飯口味不佳，產生異味。）

使用後，立即清潔並保養。

清洗並保持蓋板、內鍋、蒸氣閥的清潔。

洗完後，用乾淨的布擦去水滴。

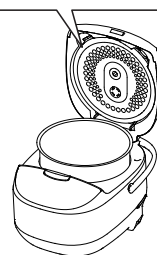

不清潔電飯煲會導致產生異味。

停止“KEEP WARM”後，不要將米飯留在鍋中（否則會產生難聞的氣味）。

煮飯過程

操作方法

<p>操作</p>	<p>1 使用 MENU 選擇烹煮功能表</p> <p>調整烹煮菜單</p> 	<ul style="list-style-type: none"> • 每次按“MENU”鍵時，“ ”標記會移位，導致選項發生變更。
	<p>2 按下 COOK 後，開始烹煮</p>	<ul style="list-style-type: none"> • 【“COOK”指示燈】亮起。顯示大概的剩餘烹煮時間。
<p>煮熟的米飯</p>	<p>當米飯煮熟時，蜂鳴器響起，表示烹煮完成。</p> <p>自動保溫</p> <p>小貼士 立即將米飯打散</p> <ul style="list-style-type: none"> • 請勿將米飯保溫12小時以上。 	<ul style="list-style-type: none"> • 【“KEEP WARM”指示燈】亮起。以分鐘為單位顯示米飯的已保溫時間。

使用後注意事項 按“CANCEL”鍵並拔出插座中的電源插頭。

擇與相應大米對應的“水位刻度”和“米飯烹煮菜單”。

烹煮菜單	烹煮的米飯類型	水位刻度	煮飯的用米量 (單位：杯)		烹煮時間的標準 (單位：分鐘)	
			1.0 L 型	1.8 L 型	1.0 L 型	1.8 L 型
QUICK COOK (快速飯 (快煮))	白米	白米	1-5.5	2-10	30~45分鐘	30~45分鐘
MIXED RICE (雜糧飯)	雜糧	雜糧	1-4	2-6	60~80分鐘	60~80分鐘
CONGEE (粥)	白米	白米	0.25-0.5	0.5-1.5	2小時	2小時
WHITE RICE (白米飯)	白米	白米	1-5.5	2-10	40~50分鐘	40~55分鐘
BROWN RICE (糙米飯)	糙米	糙米	1-4	2-6	60~80分鐘	60~80分鐘
STICKY RICE (糯米飯)	糯米	白米	1-4	2-6	35~55分鐘	45~65分鐘
CRISPY RICE (鍋巴飯)	白米	白米	1-4	2-6	60~70分鐘	60~70分鐘
SUSHI (壽司)	白米	白米	1-5.5	2-10	40~50分鐘	40~55分鐘

- 實際烹煮時間可能有10分鐘左右的誤差，具體取決於米量、水量，水溫等。
- 所有烹煮，加水不能超過MAX水位線。

定時設置

按照預設時間烹煮。

請不要使用預設設置來烹煮糙米、混有穀物的大米，以及經過調味和含有不同配料的大米。

準備

將內鍋放入電飯煲中並蓋上蓋子。

操作

1 按 **MENU** 設置烹煮功能表，將其調整至適合相應大米類型的模式

2 按下 **TIMER**



3 用 **+** **-** 設置完成時間



【例如：1點30分煮好米飯】

- 完成時間可以以10分鐘為單位進行設置。
- 如果長按“+”鍵或“-”鍵，將快速顯示時間變化。

4 按下 **COOK**

預設烹煮完成。

- 顯示預設時間，直到開始烹煮。
- 當開始煮飯時，“TIMER”指示燈熄滅。顯示剩餘烹煮時間。
- 如果未按下“COOK”鍵，電飯煲將在2分鐘後返回原初介面（表示尚未完成預設設置）。

希望取消預設設置或出現操作錯誤時

按下



定時設置

可預設的菜單

- 對於標有“X”以下各項，請勿使用預設功能。

WHITE RICE (白米飯)	BROWN RICE(糙米飯)	STICKY RICE(糯米飯)	CRISPY RICE(鍋巴飯)	STEAM(蒸煮)	SOUP(湯)	CAKE(蛋糕)	SUSHI(壽司)
○	○	○	○	○	○	×	○

預設時間

- 請勿將預設程時間設置超過14小時。（夏季最長8小時）。預設時間過長會導致腐爛，產生異味。
- 如果預設時間不超過程式烹煮所需時間，電飯煲將立即啟動烹煮。

注意

- 如果米飯過軟，請根據您的喜好減少煮米用水。
- 在預設烹煮情況下，澱粉類物質沉到底部，可能呈現淺棕色。
- 在室溫低、水溫低和水量大的情況下，米飯大約需要延後10分鐘才可以煮熟。

“KEEP WARM(保溫)” 功能

煮飯完成後自動保溫。

- “KEEP WARM” 功能可根據使用條件自動控制，從而保持米飯的溫度和味道。
- 當希望停止“KEEP WARM” 操作時，按“CANCEL” 鍵。
- 在米飯保溫過程中，當取出內鍋時，不會自動斷電。

- 在以下情況下請勿使用“KEEP WARM” 功能：（這些將導致產生異味、掉色）
 - 使用時間超過12小時。
 - 在烹煮白米之外的大米時使用。（例如：糙米、粥、添加各種調味料和配料的米飯等）
 - 在使用時鍋裡有勺子等
 - 熱冷飯時使用。

如果在“KEEP WARM” 操作期間顯示幕閃爍，請按“CANCEL” 鍵 取出米飯。

- 如果米飯仍在內鍋中，請勿停止“KEEP WARM” 操作。（這樣做可能會導致難聞的氣味）

米飯保溫小貼士

- 把米飯集中到中間區域可避免米飯過硬、過軟或過於黏稠。
- 在米飯保溫過程中，如果擔心米飯變得過於粘稠，請勿把米飯留在內鍋的一側。

斷電後希望保持米飯的溫度時

操作

如果按  電飯煲將開始保溫。

- “KEEP WARM” 指示燈亮起。

當想要停止米飯保溫時

操作

如果按 



在取出內鍋之前，請按“CANCEL” 鍵，拔下插頭切斷電源。

- “KEEP WARM” 指示燈熄滅。
- ※在米飯保溫過程中，當取出內鍋時，不會自動斷電。



食材製備方法

警告

請勿烹煮或使用本說明書中未提及的任何原料，因為此類食材可能產生蒸氣，或食材溢出或散落，造成燒傷、受傷、損傷等。

此外，這些食材還可能導致內鍋腐蝕，產生臭味等。

基本過程

作	<p>1 按 MENU 選擇功能表</p> 	<ul style="list-style-type: none">每按一次“MENU”鍵， 移動，選項相應改變。
	<p>2 按 “+” 和 “-” 調整時間</p>  <p>【例如，烹煮時間3小時】</p>	<ul style="list-style-type: none">當選擇“STEAM”或“SOUP”鍵時，時間可調整。當選擇“SOUP”鍵時，最長可選4小時，以10分鐘為單位進行調節。當選擇“STEAM”鍵時，最長可選60分鐘，以1分鐘為單位進行調節。如果長按該按鍵，時間顯示的變化速度會更快。
	<p>3 按 COOK 啟動烹煮</p> 	<ul style="list-style-type: none">按下“COOK”鍵時，相應功能指示燈會一直閃爍。
完成	<p>烹煮完成後，蜂鳴器響起。</p> <ul style="list-style-type: none">請使用防熱手套取出高溫內鍋。請勿將任何食物長時間留在內鍋中。	<ul style="list-style-type: none">由於易產生異味，所以請務必注意清潔。如果擔心產生異味，請煮沸清潔。

注意

- 加水請勿超過MAX水位線。
- 本說明書中提到的“食材製備”時間僅供參考。實際時間可能因配料、水量、室溫等而異。
- 請使用塑膠或木制炊具，防止刮傷內鍋。
- 確保內鍋已正確放入電飯煲。如果內鍋沒有緊密接觸加熱器，可能無法將食材煮熟。

如何使用蒸籠應用 “STEAM(蒸煮)” 功能

如何倒水

以RC-10DHNH & RC-18DHNH 型號為例：

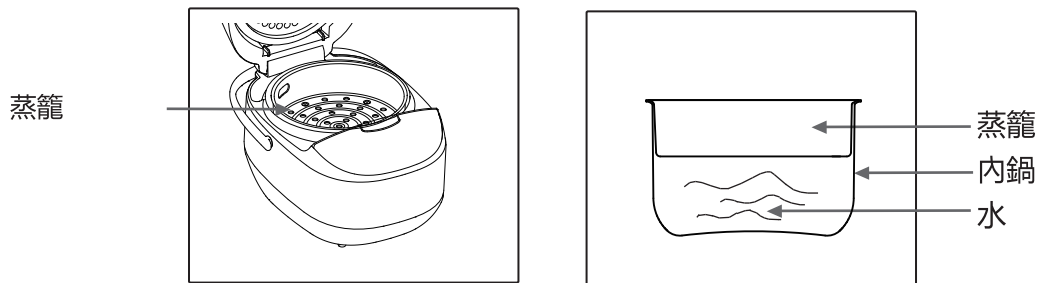

電飯煲	水位
1.0L 型	對應白米的2刻度水位線
1.8L 型	

CAKE(蛋糕)

- 1 材料準備：
小份量：雞蛋3個，細白沙糖100g，蛋糕粉（自發粉）120g，未融化的牛油30g；
大份量：雞蛋5個，細白沙糖180g，蛋糕粉（自發粉）200g，未融化的牛油50g。
(型號RC-10DHNH及RC-10DRNH，不可嘗試蒸煮大份量蛋糕)
- 2 加入糖和雞蛋，用打蛋器攪拌至起泡。然後加入蛋糕粉，用木勺攪拌混合。加入融化的牛油後快速攪拌，在起泡沒有消失前快速倒入電飯煲裡進行製作。
- 3 按“MENU”鍵選擇“CAKE”功能，然後按下“COOK”鍵，烹煮時間大約45分鐘。



CRISPY RICE(鍋巴飯)

- 1 將洗乾淨的米放入內鍋中，根據米的量（3杯長粒米）加入適量花生油和水至相應水位線。
- 2 按下“MENU”鍵，選擇“CRISPY RICE(鍋巴飯)”功能，按下“COOK”鍵。
- 3 在煮飯過程中，當聽到通知音時，將醃製好的食材鋪在米飯上，蓋上鍋蓋，耐心等待功能結束。

SUSHI(壽司)

- 1 食材（4人份）：
中國東北大米或壽司專用大米：300g
調味醋（提前混合）：醋（6大匙）、糖（1大匙）、鹽（1小匙）
- 2 將米飯快速洗淨，洗米水變清後，將水加到“WHITE RICE” 2級刻度，蓋上鍋蓋。
- 3 選擇“SUSHI”功能，按下“COOK”按鈕，烹煮時間大約50分鐘。
- 4 用浸過醋水的抹布擦拭壽司桶，並將煮熟的米飯倒入桶中。
- 5 在米飯中混入調味醋並攪拌均勻。用圓扇將米飯扇涼，直到米飯發出光澤。
*請勿在內鍋裡混合調味醋和米飯。



烹飪技巧（如下）

- 在米飯仍然很熱時拌入調味醋，這樣能夠充分使調味醋與米飯混合。
- 使用壽司桶的目的是它能夠吸收多餘的水份，這樣米飯就不會很粘稠。
- 用冷凍海帶水代替水蒸飯可以讓米飯變得更加美味。

SOUP(湯)

- 1 準備好做湯的原料（如豬骨、玉米、胡蘿蔔等），將所有原料洗淨，切成小塊，放入鍋內，加入不超過Max水量的水。
- 2 蓋上鍋蓋，按下“MENU”鍵選擇“SOUP”功能，然後按下“COOK”按鈕，等待烹飪完成。

CONGEE(粥)

- 1 準備好大米和水，將洗淨的大米放入內鍋中，根據大米的量加入水至相應水位。
注：可根據個人喜好調整水量。
- 2 選擇功能。蓋好鍋蓋，按下“MENU”鍵選擇“CONGEE”。
- 3 開始烹飪。按下“COOK”鍵進入烹飪狀態，烹飪將在指定時間完成。

注意:

- 預設時間建議不超過12小時，否則會發生異味；
- 為了保證最佳的烹飪效果，預設操作不建議用於CRISPY RICE(鍋巴飯)。

清洗&保養

! 使用不乾淨的電飯煲會產生異味。
因此，請始終保持清潔。
務必擦去蒸氣閥、內鍋的水滴。

提醒

在清潔和維護之前，請拔下電飯煲的電源插頭。
(這是導致燒傷的原因)

請勿使用以下材料

(它們是導致變形、褪色、腐蝕、裂縫劃痕的原因)

- 洗碗機/烘碗機
- 除廚房用中性洗滌劑以外的洗滌劑
- 苯、稀釋劑、酒精、清潔劑、漂白劑
- 擦洗刷、易造成劃痕的三聚氰胺海綿

活動蓋板為鋁制材料。洗碗機專用清潔劑會導致其褪色。

每次使用後，應清洗內鍋、活動蓋板、蒸氣閥和勺子。

應使用中性餐具洗滌劑清洗量杯。

在內鍋內加入調味料後若不洗滌活動蓋板會導致生銹

不要弄濕產品主體、電熱盤、溫度傳感器。

用擰乾的濕布擦去污垢和異物。

- 請勿清洗整機。
- 請勿弄濕操作部件和上蓋(蓋子)。
- 請勿將水倒入電飯煲主體的內側。
- 請勿用力拉扯散熱片包裝。(不會脫落)

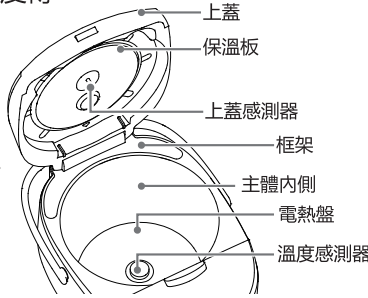

如果在電熱盤/溫度感測器上留下任何米粒，請用擰乾的濕布擦拭乾淨。

使用棉簽清除通風口(電飯煲底部)和按鈕縫隙中的污垢、異物。

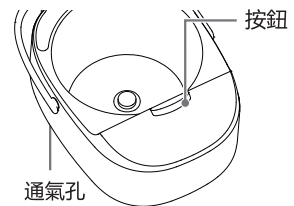

蒸氣閥

每次使用時

拆卸蒸氣閥

向上拉可將其取下



安裝蒸氣閥

放入空心部分至完全安裝到位

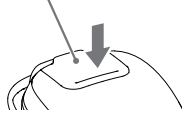

打開

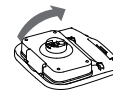

關閉



活動蓋板

每次使用時

安裝活動蓋板

向前拉可將其取下

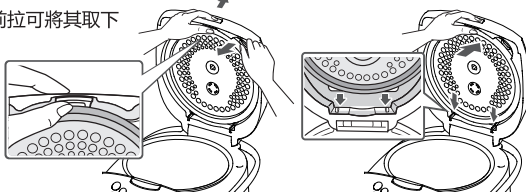

安裝活動蓋板

- ① 沿著下方兩個箭頭的方向插入。
- ② 按下使其安裝到位。

- 在沒有安裝活動蓋板的情況下，上蓋無法完全閉合(以防止忘記安裝活動蓋板)

煮沸清洗(大約每週一次)，每當有異味也需如此。

- 1 向內鍋加水(直到達到 WHITE RICE 水位2)，然後蓋上蓋子。
- 2 按下“MENU”鍵選擇(WHITE RICE)功能，然後按“COOK”鍵。
- 3 當變為“KEEP WARM”時，按“CANCEL”鍵。當電飯煲冷卻後，取下活動蓋板、內鍋和蒸氣閥，然後清洗晾乾。

- 不要添加除水之外的任何物質(例如：洗滌劑等)。
- 不要用蒸氣連續清洗。
- 有些氣味可能無法完全去除。

故障情況

在提交維修請求之前，請再次進行檢查。如果無法自行檢查或採取進一步行動，請向您購買電飯煲的商店詢問。

故障案例		成因/調查點 (參考頁)
電飯煲未通電。 米飯不熟。 雖然經過了“KEEP WARM”處理， 但是，煮熟的米飯僅溫熱。 米飯水分過多。 按鍵操作無法執行。		<ul style="list-style-type: none"> 電飯煲的插頭是否已拔出，插頭是否從插座中掉出來？ 如果在烹煮或“KEEP WARM”操作期間顯示當前時間，說明電飯煲處於電源故障狀態，並且插頭已斷開或斷路器已切斷電源。
米飯	軟糯 米糊 相互粘連 味道不好	<ul style="list-style-type: none"> 請減少煮米用水量。 米飯煮熟後，立即把米飯完全打散。 請減少煮米用水量。 預先浸泡大米，再使用預設置烹煮，會使米飯更軟糯。 淘米力度過大或使用漏勺淘米可能導致米粒破裂，煮熟後成呈現黏糊狀。 是否適用pH 9以上的鹼性或熱水煮米？
	變硬 變乾 味道不好	<ul style="list-style-type: none"> 請增加煮米用水量。 請在烹煮前浸泡米粒。 是否使用高硬度的礦泉水？
	糊鍋 ※ 輕微焦化並呈現淺棕色 不是故障或失敗的結果	在下列情況下，大米容易糊鍋： <ul style="list-style-type: none"> 當淘米不充分時。 當浸泡時間過長時。 對於免洗米，淘洗1-2次可以減少糊鍋。 當溫度感測器上粘有異物。 當在大米中添加調味料和其他配料時。烹煮糙米等時。
	味道不好，烹煮效果不佳	<ul style="list-style-type: none"> 是否在電飯煲內測、活動蓋板等仍處於高溫時煮飯？請等待這些部件的溫度降至人體常溫後再煮飯。 在“QUICK COOK”功能下，米飯可能過硬或過軟。 是否有任何異物黏附在溫度感測器、活動蓋板、蒸氣閥上？ 內鍋是否變形？是否忘記連接活動蓋板、蒸氣閥等？ 是否存在電源故障？是否插上電飯煲的插頭？
開水 飯米	異味 ※ 請在下次使用前煮沸並 晾乾，以防散發異味。	<ul style="list-style-type: none"> 是否按照下列方式使用“KEEP WARM”功能？ 使用時間過長。在烹煮除白米飯之外的食材時使用。熱冷飯時使用。 在使用時勺子還留在內鍋中。使用時間超過12小時。 電飯煲主體/活動蓋板/蒸氣閥是否未清潔？ 在每次烹煮後請取下活動蓋板/蒸氣閥進行清洗，然後用乾淨的布擦去水漬。 淘米是否足夠充分？預設烹煮時間是否過長？ 在關閉“KEEP WARM”功能後內鍋中是否還有米飯？ （按錯按鍵，或因電源故障斷電） 在關閉“KEEP WARM”功能後內膽中是否還有米飯？ 請檢查上述情況，並更改“KEEP WARM”設置。
	米飯顏色變黃、變乾。	<ul style="list-style-type: none"> 是否有任何異物粘在活動蓋板包裝、內鍋邊緣或電飯煲主體框架上？ 溫度感測器或內鍋外側是否粘附異物？ 蒸氣閥是否正確連接？ “KEEP WARM”時間是否太長？是否重複加熱？ 當米飯較少時，“KEEP WARM”操作可能會導致底部的米飯變硬變乾，所以請把米飯集中到中間區域。

故障情況

(續)

故障情況 (續)

故障案例		成因/調查點 (參考頁)
	糊狀米	<ul style="list-style-type: none"> ● 減少煮飯水量，然後保溫。 ● 米飯煮熟後，立即把米飯完全打散。 ● 把米飯集中到內鍋的中間區域，有時可以把米飯完全混在一起，避免粘在內鍋的內表面。
煮飯、保溫	漏氣 ※ 米飯煮熟後進行檢查	<ul style="list-style-type: none"> ● 是否有任何異物粘在活動蓋板、內鍋邊緣或電飯煲主體框架上？ ● 活動蓋板上是否有劃痕？活動蓋板/內鍋是否變形？ ● 活動蓋板是否正確連接？
	沸騰溢出	<ul style="list-style-type: none"> ● 是否存在米量小、水量大、淘米不充分等問題？ ● 您的煮粥功能表是否有問題？ ● 溫度感測器上是否粘有異物？ ● 蒸氣閥內部是否清潔？ ● 活動蓋板、蒸氣閥是否正確連接？
	內鍋上形成薄膜。	<ul style="list-style-type: none"> ● 扁圓形薄膜是大米中甜味成分（澱粉）融化乾燥後形成的。這種情況不是故障。
	活動蓋板、內鍋等處出現水滴。	<ul style="list-style-type: none"> ● 活動蓋板、內鍋等處出現水滴，為了防止變乾，這種情況不是故障。
	打開蓋子時，水沿著產品外壁處滴下。	<ul style="list-style-type: none"> ● 打開蓋子時，可能會有一些水沿著產品外壁處滴下，具體取決於開蓋時間、室溫等。 ● 溫度感測器/內鍋外側是否粘附異物？
預設設置	立即開始烹煮	<ul style="list-style-type: none"> ● 如果預設時間短於烹煮功能時間，電飯煲將立即開始烹煮。
	未在預設時間煮飯	<ul style="list-style-type: none"> ● 如果室溫/水溫低、水量大，電飯煲將延遲10分鐘開始煮飯。
	無法完成預設操作	<ul style="list-style-type: none"> ● 在設置預設操作時，是否已將內鍋正確放入電飯煲？ ● 您是否忘記將電飯煲設置為預設操作，或忘記按“COOK”鍵等？
操作提示	難以蓋上蓋子 無法蓋上蓋子	<ul style="list-style-type: none"> ● 活動蓋板是否正確連接？為了避免忘記安裝活動蓋板，在沒有安裝活動蓋板的情況下，外蓋無法完全合上。 ● 扣鎖鍵的間隙是否有異物等？
	按鍵操作無法執行	<ul style="list-style-type: none"> ● 是否插入插頭？是否連接活動蓋板？ ● 在選擇“食材準備”功能時，例如<CAKE>，不可使用“TIMER”功能，按鍵不會起作用。
	“COOK”指示燈熄滅 運行中途停止。	<ul style="list-style-type: none"> ● 如果不小心按下“CANCEL”鍵，或者電源故障長時間持續，會切斷電源。
	在“KEEP WARM”模式下， 時間指示燈閃爍	<ul style="list-style-type: none"> ● 這說明米飯長時間保溫，請立即停止保溫。

故障案例

成因/調查點 (參考頁)

食材製備	如果該食材需要較長的時間制備，則不會消耗設置的時間。	<ul style="list-style-type: none"> 設置時間從“準備烹煮”溫度開始計算。但是，將溫度加熱至烹煮所要求的溫度需要一定的時間。因此，實際製作時間比設置時間要長。
	食物烹煮結果不佳	<ul style="list-style-type: none"> 食材的最終烹煮效果可能因配料和測量方法等而異。請檢查並確認烹煮程式和烹煮時間。下列因素可能導致烹煮失敗、蒸氣洩漏或蓋子無法正常關閉。 有異物黏附在溫度感測器上。內鍋變形。鍋內留有熟食。電源出現故障。電飯煲插頭未插入插座中。
其他	烹煮時會發出聲音。	<ul style="list-style-type: none"> 【滴滴聲】調整溫度的聲音，【呼呼聲】蒸氣發出的聲音。（這種情況不是故障）。 【嘟嘟聲】水滴在內膽的外表面噴濺和沸騰的聲音 在將內鍋放入電飯煲之前，請擦去內膽外表面的水滴。
	有塑膠氣味。	<ul style="list-style-type: none"> 在第一次使用時，可能會產生一些難聞的氣味，但是，在使用過程中，這種氣味會逐漸消失，如果感到擔心，請煮沸並清洗。
	內鍋外表面有劃痕、污垢。	<ul style="list-style-type: none"> 使用後，內表面塗層可能會刮傷或變髒，但對烹煮或加熱品質沒有影響。
	在烹煮食物過程中，關閉斷路器。	<ul style="list-style-type: none"> 如果同時使用電飯煲和其他電器，可能會導致功耗超標，斷路器會切斷電源。請使用獨立插座。

電源故障

當中途拔出電飯煲的電源、電飯煲連接插頭脫落或斷路器切斷電源時，採用以下的處理辦法。

在預設烹煮過程中	<ul style="list-style-type: none"> 從電源故障中恢復後，電飯煲將恢復至初始狀態
在煮米過程中	
在保溫過程中或在蒸煮過程中	

※如果電源長時間持續故障，米飯的烹煮效果可能不佳。

錯誤提示

異常現象自檢

顯示異常原因判斷

請委託當地經銷商或服務網點進行維修或安裝。

指示	異常的顯示		可能的原因	對應方法
常亮	8	88	主熱敏電阻（底部傳感）開路	拔電後重新上電仍出現，請送當地售後服務維修。
常亮	2	22	主熱敏電阻（底部傳感）斷路	
常亮	5	55	上蓋感測器（手柄熱敏電阻）開路	
常亮	6	66	上蓋感測器（手柄熱敏電阻）斷路	
常亮	0	00	異常溫度系統錯誤	
常亮	8	80	通信接受故障	
閃爍	8	80	通信接受故障	

規格

型號名稱	電源	消耗電力 (煮飯)	外形尺寸	本體 品質	頻率
RC-10DRNH	220-240V~	625-744W	L368*W271*H212(mm)	3.5kg	50/60Hz
RC-18DRNH		780-928W	L393*W287*H254(mm)	4.4kg	50/60Hz
RC-10DHNH	220-240V~	605-720W	L368*W271*H212(mm)	3.2kg	50/60Hz
RC-18DHNH		760-904W	L393*W287*H254(mm)	3.9kg	50/60Hz

TOSHIBA

For household use

ELECTRIC RICE COOKER Instruction Manual

With cooking menu

Model

RC-10DRNH
RC-18DRNH
RC-10DHNH
RC-18DHNH

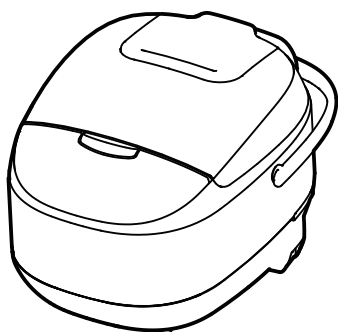

Thank you for purchasing Toshiba rice cooker.

- Please read the instruction manual and use it correctly for your own safety.

Before using, please read “Safety Cautions” and “Please follow the instructions”. (page 2 – 4)

- After reading, please keep the instruction manual at a place where any person who is going to use this cooker can find and see it.

Contents

Before Use	Safety Cautions	2
	Please observe and follow	7
	Parts Identification	8
Rice Cooking	Basic steps to cook rice	9
	How to cook delicious rice	10
	Rice cooking procedures	11
	Standard of cooking amounts and cooking times	11
	Display of cooking times	11
	Setting the timer	12
	Clock Adjustment	12
“Keep Warm”	13	
Making proper use	Food preparation methods	14
	• How to use “Steam” with steam stand ...	15
	• Cake & Crispy Rice	16
	• Sushi	17
	• Sou & Congee	18
Clean & Care / Special notices	Clean & Care	19
	• How to take out and put in the inner lid, steam port	19
	• Cleaning by boiling	19
	In case of problems	20
	Power failure	22
	Error indication	23
	Specifications	23

SAFETY CAUTIONS

Please follow for your own safety

■ This is to explain the extent of injuries and damages that may occur if the instructions are not followed.

 **WARNING** Probable causes of “severe injuries” or “death”

 **CAUTION** Probable causes of “bodily harm” or “property damages”









■ The explanation are divided into sections according to instruction details.

 “PROHIBITION” cases

 “OBSERVATION” cases

 “CAUTION” cases

 **WARNING** To prevent fires, burns, electric shocks, electricity leakage, short circuits

-  • Warning: Avoid spilling to the connector.
-  • Children should be supervised to ensure that they do not play with the appliance.
-  • The heating element surface is subject to residual heat after use, do not touch.
-  • This appliance is not intended for use by persons (including children) with reduced physical, sensory or mental capabilities, or lack of experience and knowledge, unless they have been given supervision or instruction concerning use of the appliance by a person responsible for their safety. This appliance is for household use only. Do not use outdoors.
-  • Don't place the appliance to the place close to heat-sensitive curtains.
-  • This appliance is intended to be used in house-hold and similar locations such as: Staff kit-chenareas in shops, office and other working environments; farm houses; by clients in hotels, motels and other residential type environments; bed and breakfast type environments.
-  • If the supply cord is damaged, it must be replaced by a special cord or assembly available from the manufacture or its service agent.
-  • Please turn off and unplug the appliance before cleaning, maintenance or relocation and whenever it is not in use.

 **WARNING** Misuse may cause potential injury



Stop using immediately if abnormalities/malfunctions are found. Unplug immediately and contact the Store from which the product was bought or Toshiba service center for examination and repair.

- The power plug / cord is abnormally hot.
- The cooker has a burnt smell.
- The cooker is partly cracked, loosen, wobbling.
- The inner pot, outer lid, or inner lid is broken or deformed.
- The cooking heater becomes bent.



Do not disassemble, repair, or modify the cooker by yourself.

For any repair, please consult the Store from which the product was bought or Toshiba service center.

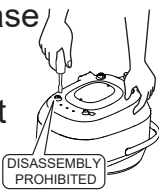

Do not insert any foreign object into the air vent or blank gaps at bottom of the cooker.

Especially metal articles e.g. pins, wire, etc.

Do not insert any foreign object.



Do not immerse the cooker body and the power plug and cord in water or pour water over them.

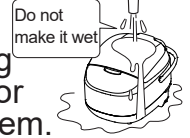

Do not place them in a place exposed to water.



Do not allow anyone unfamiliar with this cooker handling to use it by themselves.

Do not use the cooker where children can reach, particularly keep your eyes on children during cooking or right after cooked.



While cooking, do not open the inner lid or move/carry the rice cooker to other places.

Use the power plug / cord correctly.



● Use a separate socket of 220-240V. Using the cooker with other appliances will result in overheating leading to fire hazards. Do not connect the product to the power source which is not specified in the operation manual.

- If an extension cord is necessary, use it separately.
- Fully insert the plug into the socket.
- Periodically remove dust from the power plug. Accumulation of dust, due to humidity, will cause insulation failure leading to fire hazards. Use dry cloth to wipe dust away.
- Make sure there is no metallic articles or trash (e.g., pin, etc.) left at the pointed end of cooker-plug.



● Do not allow children to flap the plug. Please be careful, not allow children to flap the plugs.

● Hold the power plug head when pulling it out from the outlet. If not, it may catch fire, due to an electric shock, a short circuit, etc. Insert the power plug into the power outlet as far as the base of the power plug.

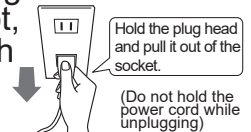

● Always unplug when not in use. If not, due to insulation deterioration, it may cause an electric shock, electricity leakage, fire hazards, etc.

※ Illustration in the instruction manual might be different from the product you purchased.



WARNING

To prevent fires, burns, electric shocks, electric leakage, short circuit, etc.

Use the power plug/cord correctly. (continued)



- Do not use damaged cords/power plugs, etc., or those with loose insertion.
- Do not let steam reach the power plug or other electrical appliances. Especially be careful when using any kitchen storage shelf.
- Do not use any power cords other than the cooker attachments and do not use the cooker attached cords for other appliances.
- Do not place the power plug or cord in the place with high temperature, flooded water, and high humidity or touch it with sharp-edge object.
- If power cord damaged, purchase specific replacement from the producer.



- Handle the power cords with care. Do not pull, tuck, twist, bend them with force in unnatural ways or turn on electricity while they are still coiled. Do not place heavy objects on their tops. Do not modify or deform them in any way.



- Do not insert or pull out the power plug or the cooker-plug with wet hands. Make sure your hands are dry before touching the power plug.

Do not touch the product, cord, or power plug with wet hands. Do not operate the product if the cord or power plug is damaged, or the power plug is inserted improperly.

Use the power plug/cord correctly. (continued)



The steam port is hot. Keep your face or hands away from it. Be careful, especially with babies and infants.



Make sure to install the steam port.



Do not use the cooker for any purposes other than those indicated in the instruction manual.

Because it may cause food or steam contained inside spill or burst out, resulting in burn wounds/injuries.

«Examples of inappropriate cooking ways »

- Putting materials that may block the steam vent, for example, cooking sheets, aluminum foil, lye-removing sheets, food wraps, or thin-layer ingredients such as greens, tomatoes, beans, etc.
- Cooking the food that's easy to spill out e.g., jams, beans, etc.
- Putting ingredients in plastic bags and heating in the cooker.



CAUTION

To prevent electricity leakage, electric shocks, bodily harm, burn wounds, fire hazards, and property damages.

To prevent boiling over or spilling out



- Rice porridge is to be made with lots of water, so we don't use "White Rice" or "Quick Rice" menu. Please make rice porridge by "Congee" menu.



- Do not increase water too much more than the indicated water level scale. The standard is within 2 mm against the indicated water level scale.

To prevent burn wounds / injuries.



- While using or after using, do not touch hot parts including the inner lid, the cooking heater, the inner pot, the steam port, the heat sink, etc.
- When not in use, do not press the "Cook" key or "CANCEL/KEEP WARM" key. Because the cooking heater, the inner pot, the outer pot, the inner lid will be at high temperature.
 - While moving the cooker, do not touch the hook button.
 - Do not shake the cooker while holding the handle.
 - While cooking, do not set up the handles.
 - Do not turn on the cooker, when the pot is empty. Because it may cause overheating, breakdowns, and malfunctions.



- To maintain or repair, do it after unplugging and the cooker has cooled down. There may be hot water still gathering in the steam port.
- After cooking, beware of steam or hot water dripping from the inner lid, while opening it.
- Before take out the inner pot, press the "CANCEL/KEEP WARM" key. Although the inner pot is taken out during cooking or warming, the power will not be automatically cut off.
- Please use a dry dishcloth, mittens, etc. to take out the hot inner pot.

(continued)

SAFETY CAUTIONS

Please follow for your own safety



CAUTION

To prevent electricity leakage, electric shocks, bodily harm, burn wounds, fire hazards, and property damages.

Do not use the cooker in the following places



- A place where near the naked flame, wet area, or hot and high humidity area.
Also beware for the accessories and attachments.
- An uneven/unstable place or on heat-sensitive carpets, mats, etc. They may cause burn wounds, fire hazards.
- On materials that may block the air vent, for example paper, cloth, carpet, etc.
- A place where the lid cannot be fully opened. It may cause burn injuries and damages.

- The high electromagnetic area.
- A place close to walls, furniture, etc.

When putting the cooker on a kitchen storage shelf, be careful not to let steam be confined.

- Sliding table with insufficient load strength.
The load strength standard is
- 1.0L type : 10 kg and up;
- 1.8L type : 12 kg and up;

For safe use



- Do not use any other things instead of the inner pot which is specifically designed for the cooker.
- Do not bring any flammable object, hazardous object, chemicals, or flammable gas near or in the product.
- Read the instruction manual carefully and thoroughly before using the product.
- Always inspect that the product is in a good operating condition before using by following the recommendation in the instruction manual.
- Remove all packing materials.

Please observe and follow

To prevent breakdowns, malfunctions, etc.

Do not use the cooker in the following places.

They may cause malfunctions, deformation, discoloration, etc.

- A place which is exposed to direct sunlight
- A place where oil, etc., splashes

Do not put any dishcloth on the lid, especially on the steam port.

Steam may be confined, resulting in malfunctions, deformation, discoloration, etc. of the lid, the steam port, and operation parts.

Keep the cooker and surroundings clean and ready to use. Dust, bugs, etc. entering inside of function-maintaining parts (such as the air vent, etc.) may cause malfunctions of the cooker.

Do not use the cooker in the following ways to prevent coating inside the inner pot from getting scratched and getting unstuck

- Do not put dishes in the inner pot and use it as a washing-up bowl.
- Do not use a scrubbing brush or dish washer to wash the inner pot.
- Do not use any cleanser, bleaching agent to wash the inner pot. (use neutral detergent for kitchen use.)
- Rice seasoned and cooked with various ingredients cannot be kept warm. (Please wash right after using seasonings.)
- Do not use vinegar.
- Do not scrub with a scoop or strike with a sieve.
- Do not use a metal ladle or a whisk.

Wipe away water droplets or any foreign substances.

If using while foreign substances are left, stuck to the cooking heater, the temperature sensor, the outer part of inner pot, the packing of inner lid, etc., rice will not be well cooked, resulting in malfunctions.

Do not use the inner pot with a gas range, IH cooking appliances, microwave ovens, etc. They may cause deformation, discoloration, malfunctions, etc.

Stop using if the cooker become loose, cracked, fell down.

Please contact the store from which the product was bought or Toshiba service center for examination and repair.

Parts Identification

- When using for the first time, please wash the inner pot, inner lid, steam port, other accessories and attachments (page 16)
- At first use, there might be an odor from plastic, etc. This odor will disappear after using

Body

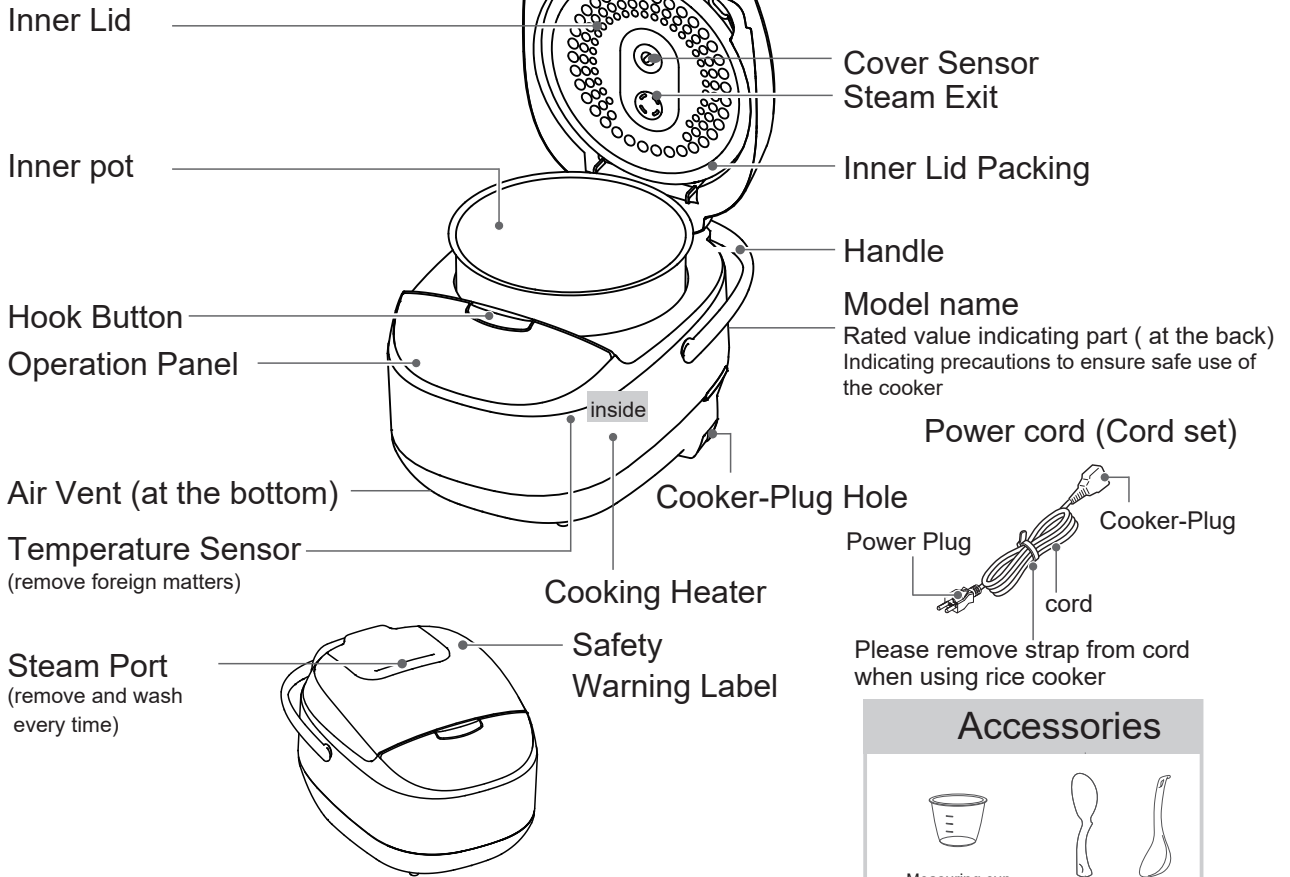

Accessories

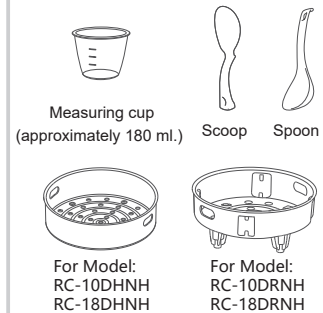

Operation Panel

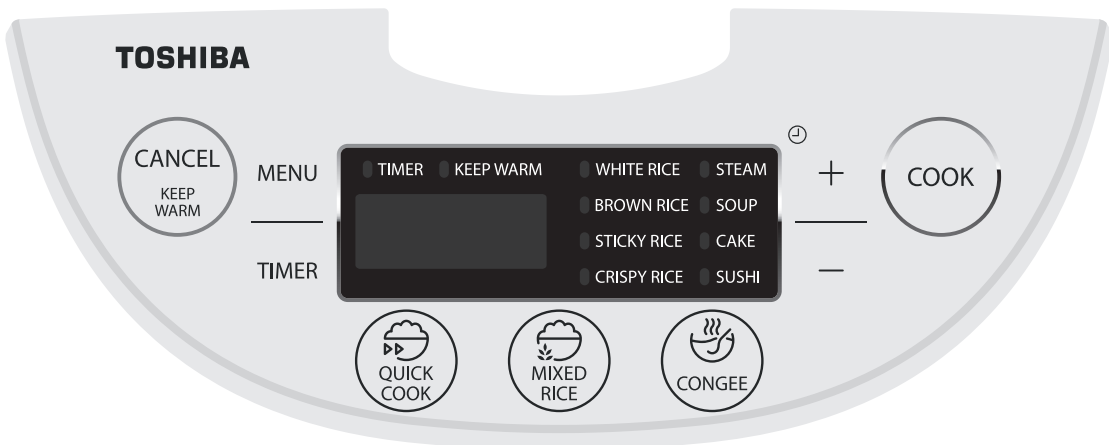

Basic Steps to Cook Rice

Preparation

Basic Steps

1

Measure rice with the measuring cup provided.

A level cup = 180ml

[Good example]



[Bad example]

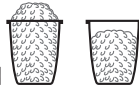

- It might differ from other food measuring cups (200ml) or other rice measuring vessels.

2

Wash rice.

Quickly rinse the rice until the water runs clear.

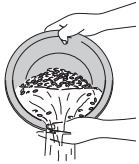

The inner pot can be used to rinse rice

- Fill plenty of water, swirl the rice around quickly and gently (with one hand), then pour out the water immediately.
 - Polish the grains of rice and rinse several times, until the water runs clear.
- In case of washing rice in the inner pot, please do not use any whisk.

3

Adjust the water level. Select the water level scale based on the size and number of the measuring cup.

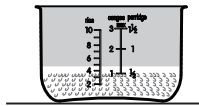

Level off the rice, on a flat place.

- please adjust the water level according to your taste.

⚠ Standard: adjust within 2mm against the indicated scale

4

Wipe off water droplets, foreign substances, and set the inner pot, then close the lid.



If there are water droplets or foreign substances left or stuck to the following parts, please wipe off.

- Water droplets or foreign substances left may cause steam leakage, cause the lid to fail to close completely, and cause the rice not to cook well,

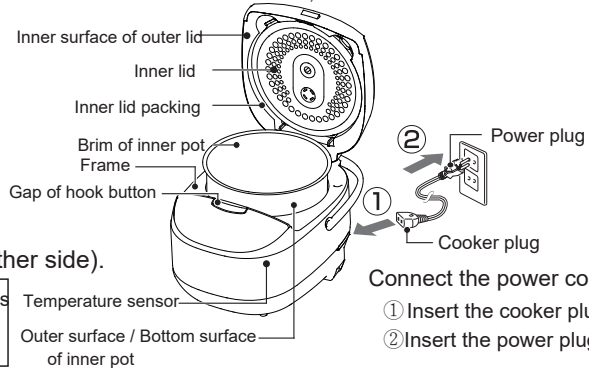

Levelly place the inner pot on the bottommost part inside the cooker (without inclination to either side).

Turn the inner pot 2-3 times in the direction as shown by the arrows, to have it closely touch the cooking heater.

Connect the power cord:

- Insert the cooker plug.
- Insert the power plug.

5

Select the cooking menu, confirm, and start cooking.



Press the "Cook" key.

- There's no need to soak the rice.
- Please do not forget to close the lid and attach the steam port.

If the buzzer sounds, it indicates that the rice has cooked. "KEEP WARM" lamp turns on. ▶ After using, press the "CANCEL" key and unplug from power outlet.

⚠ Please press the "CANCEL" key to cut off power before removing the inner pot.

※ During keeping the rice warm, although removing the inner pot, the cooker will not turn off automatically.

Basic Steps to Cook Rice

- In the case of "cooking immediately after keeping warm" or "continuously cooking" please wait until the temperature of the inner lid, the temperature inside the cooker, etc., have cooled down to the normal human body temperature.

How to cook delicious rice



Measure rice accurately (level off the top).



Do not shake the measuring cup

If shaking, the amount of rice will increase more than enough.

Measuring cup provided with the cooker

Do not wash rice with hot water.

Do not wash rice for a long time.

Washing with hot water or washing slowly may cause a bad odor of rice bran.

Gently wash, to avoid smashing the rice grains.

Lightly rub the rice grains one another. (Cracked or broken rice tends to get mushy and sticky when cooked.)

Adjust water level according to preference.

If preferring harder rice	lower the water level below the indicated scale
If preferring softer rice	raise the water level above the indicated scale
Freshly-harvested rice	slightly below the indicated scale
Whole rice	according to the indicated scale
Old Rice	slightly over the indicated scale
Rice during rainy season to summer	
Wheat	

The condition and quality of each kind of rice is different, depending on brands, places of origin, storage conditions. Therefore, please adjust according to your preference.

When cooking is finished, loosen the cooked rice entirely with a scoop.

Please loosen the cooked rice by holding the inner pot with a dry cloth or mittens to prevent it from clumping or sticking together.

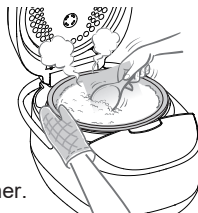

“Keep warm” operation should end in a short period of time.

In the case of “rice seasoned and cooked with various ingredients”, small amount of rice, or keeping warm for extended periods, it is advised to wrap in plastic wraps and keep in the freezer.

About Rice

- Buy a proper amount of new rice of which the rice-polishing date indicates that it can be completely consumed within 2 weeks - 1 month.
- Prevent oxidation by keeping rice in a tightly closed container and store it in a dark, cool place.

After washing, do not leave the rice in a colander.

Avoid leaving the rice in a colander.



The rice grains may get cracked resulting in becoming mushy and sticky when cooked.

Unsuitable kinds of water for rice cooking

Hard mineral water



Ionized water over pH9

(A cause of hard and dry rice)

(A cause of mushy and sticky rice)

Rice cooking water should be 30°C or lower.

It is recommend to use cold water for pre-programmed cooking in summer.

In summer, use cold water



(Too-high water temperature will result in undelicious cooked rice and unpleasant odor.)

After using, immediately clean and care.

Wash and keep the inner lid, inner pot, steam port clean all the time.

After washing, wipe off water droplets with a clean cloth.

(Leaving the cooker dirty will cause bad smells.)



After stop “Keep Warm” operation, do not leave rice in the pot (or it will cause unpleasant odors).

Rice Cooking Procedures

Operation Method

Operation	<p>1 Select the cooking menu with Menu</p> <p>Adjust to the cooking menu</p>	<ul style="list-style-type: none"> ● Every time we press the “Menu” key, “I” mark will move and the selection will consequently change.
	<p>2 Cooking starts, after pressing COOK</p>	<ul style="list-style-type: none"> ● Press the “COOK” key, the lamp of the corresponding menu will be from flashing to being on all the time.
Rice Cooked	<p>When rice is cooked, the buzzer sounds to show cooking is finished.</p> <p>Keeping warm automatically</p> <p>TIPS Immediately loosen cooked rice</p> <ul style="list-style-type: none"> ● Please do not keep the rice warm for longer than 12 hours. 	<ul style="list-style-type: none"> ● [“KEEP WARM” lamp] turns on. Showing the elapsed time for keeping rice warm in units of one minute.

Rice Cooking Procedures

After using Press “CANCEL” key and pull the power plug from the outlet.

Select the “Water level scale” and the “Rice Cooking menu” that match the type of rice to be cooked.

Cooking menu	Type of rice to be cooked	Water level scale	cooking amounts of rice unit : cup		Standard times for cooking unit : minute	
			1.0 L type	1.8 L type	1.0 L type	1.8 L type
QUICK COOK	White rice	White rice	1-5.5	2-10	30~45 min	30~45 min
MIXED RICE	Mixed rice	Mixed rice	1-4	2-6	60~80 min	60~80 min
CONGEE	White rice	Congee	0.25-0.5	0.5-1.5	2Hour	2Hour
WHITE RICE	White rice	White rice	1-5.5	2-10	40~50 min	40~55 min
BROWN RICE	Brown rice	Brown rice	1-4	2-6	60~80 min	60~80 min
STICKY RICE	Sticky rice	White rice	1-4	2-6	35~55 min	45~65 min
CRISPY RICE	White rice	White rice	1-4	2-6	60~70 min	60~70 min
SUSHI	White rice	White rice	1-5.5	2-10	40~50 min	40~55 min

- Actual cooking time may vary by about 10 minutes, depending on amounts of rice, amounts of water, water temperatures, etc.
- For all cooking menu, don't add water exceed to the “MAX” level scale.

Setting the timer

Cooking at the preset time.

Please do not use pre-programmed settings for germed brown rice, rice mixed with cereals, and rice seasoned and cooked with various ingredients.

Preparation



Put the inner pot in the cooker and close the lid.

Operation

1 With  set the cooking menu,
adjusting to make it proper for the kind
of rice to be cooked

2 Press 



3 Set the completion
time with  



【example : The rice will finish cooking at half past one.】

- The completion time can be set in units of 10 minutes.
- If we keep pushing “+” key or “-” key for a while, the time display will change quickly.

4 Press  Pre-programmed cooking
is completed

- Pre-programmed time will be displayed until rice-cooking starts.
- When rice-cooking starts, the “TIMER” lamp will turn off.
- If the “COOK” key is not pressed, it will exit from preset mode to standby mode after 2 minutes.

When desiring to cancel
the pre-programmed settings
or
if the operation is incorrect

Press



Setting the timer

Possible pre-programmed menus

- Please do not use pre-programmed function to each of the following items marked with “X”.

white rice	brown rice	sticky rice	crispy rice	steam	soup	cake	sushi
○	○	○	○	○	○	×	○

Pre-programmed Time

- Please do not set preprogrammed times so long over 14 hours (maximum 8 hours in summer).
Too long preprogrammed time will cause decay and unpleasant odours.
- If the preprogrammed time is not more than the cooking time of the selected menu, the cooker will start cooking at once.

Notice

- If the cooked rice is quite soft, please reduce the water according to your preference.
- In case of pre-programmed cooking, starchy substances will sink to the bottom and may become light brown.
- In case of low room temperatures, low water temperatures and large amounts of water, rice may cook later by about 10 minutes.

“KEEP WARM” feature

After cooking, the rice will automatically be kept warm.

- “KEEP WARM” temperature can be controlled automatically depending on using conditions, in order to keep our rice warm and delicious.
- Press the “Cancel” key, when desiring to stop “KEEP WARM” operation.
- During keeping rice warm, although the inner pot is removed, power will not be cut off automatically.

- Do not use the “Keep Warm” feature in the following cases: (They are causes of bad odors and decoloration)
 - using for longer than 12 hours.
 - using for any rice other than white rice. (e.g. germed brown rice, congee, rice seasoned and cooked with various ingredients, etc.)
 - using while there is a scoop, etc. in the pot.
 - using for cold rice.

If the display blinks during “Keep Warm” operation, please press the “Cancel” key, and take the rice out.

- Do not stop “Keep Warm” operation, while the rice is still in the inner pot. (It may cause a bad smell)

Tips for keeping rice warm

- Gathering rice to central part will help it not to get too hard, too mushy and sticky.
- During keeping rice warm, If worrying that it may get too mushy and sticky, please do not let the rice left at the side of inner pot.

When desiring to keep rice warm after finishing cooking.

Operation

If pressing  it will start to keep the rice warm.

- “Keep Warm” lamp will turn on.

When desiring to stop keeping rice warm

Operation

If pressing 

- “KEEP WARM” lamp turns off.
- ※ During keeping rice warm, when the inner pot is removed, power will not be cut off automatically.









Before taking out the inner pot, please press the “Cancel” key and unplug to cut off power.

Food Preparation Methods

⚠ WARNING

Please do not cook or use any ingredients which are not mentioned. because they may cause steam or ingredients to spill over or scatter, resulting in burn wounds, injuries, damages, etc. Besides, they may be causes of inner-pot corrosion, bad odors, etc.

Basic procedures

Operation	<p>1 Select menu by </p> 	<ul style="list-style-type: none"> • Every time the “MENU” key is pressed,  will move, and the selection will consequently change.
	<p>2 Adjust time by “+” and “-”</p>  <p>[Ex. Cooking time 3 hours]</p>	<ul style="list-style-type: none"> • Only the “STEAM” and “SOUP” can adjust time. • When you choose the “Soup” key, it can be set to the maximum of 4 hours with 10minutes/unit. • When you choose the “Steam” key, it can be set to the maximum of 60 minutes with 1 minute / unit. • If keep pressing the key, times displayed will change more quickly.
	<p>3 Start cooking by </p> 	<ul style="list-style-type: none"> • Press the “COOK” key, the lamp of the corresponding menu will be from flashing to being on all the time.
Completion	<p>When cooking is finished, the buzzer sounds.</p> <ul style="list-style-type: none"> • Please use pot holders to take the inner pot out, because it is very hot. • Do not leave any food in the inner pot for a long time. 	<ul style="list-style-type: none"> • It is easy to smell bad, so please always clean with good care. Please clean by boiling whenever worrying about any bad odor.

Food Preparation Methods

Notes

- Don't add water over “MAX” water level.
- “Food preparation” times mentioned in the instruction manual are for reference only. The actual time results may vary depending on ingredients, room temperature, etc.
- Please use plastic or wooden cooking utensils, to prevent the inner pot from getting scratched.
- Make sure the inner pot has been put properly in the cooker. If it does not closely touch the cooking heater, the food may not be well made.

How to use “STEAM” with steam stand

How to pour water

Take the model of RC-10DHNH & RC-18DHNH as an example:

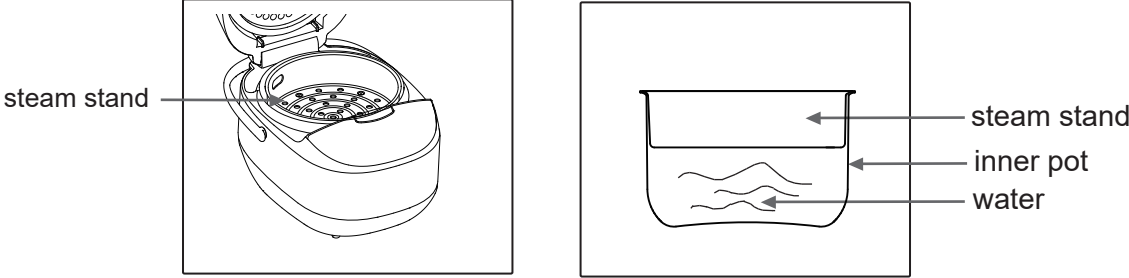

Rice cooker	Water level
1.0L type	Follow "White Rice" wate level 2
1.8L type	

CAKE

- 1 Materials preparation:
Small amount: 3 eggs, 100g caster sugar, 120g cake flour (baking powder), 30g butter (not melted).
Large amount: 5 eggs, 180g caster sugar, 200g cake flour (baking powder), 50g butter (not melted).
(Cake tests for Large amount are not carried out for below models: RC-10DHNH & RC-10DRNH).
- 2 Put in sugar and eggs, stir with a whisk until it is frothy. Then add cake flour and stir with a wooden spoon. Add melted butter, stir quickly and quickly pour into the electric cooker inner pot for operation before the bubbles disappear.
- 3 Press the "MENU" button and choose "CAKE" function, then press "COOK" button. The cooking time is around 45 minutes.



CRISPY RICE

- 1 Put rice that is washed clean into the inner pot, and add water to the corresponding water line based on rice amount (3 cups of long grain rice) as well as the appropriate amount of peanut oil.
- 2 Close the lid, Press "MENU" button to select "CRISPY RICE" function, and press "COOK" button, and wait patiently for the function to end.

SUSHI

- 1 Ingredients (for 4 people):
China's northeast rice or special rice for sushi: 300 g
Seasoned vinegar (mixed in advance): Vinegar (6 big spoons), sugar (1 big spoon) and salt (1 small spoon)
- 2 Wash rice quickly until the water is clear, add water to the water level scale 2 for "WHITE RICE", and close the lid.
- 3 Select the "Sushi" function, and press the "COOK" button, the cooking time is around 50 minutes.
- 4 Wipe the sushi barrel with a cloth soaked in vinegar water, and pour cooked rice into the barrel.
- 5 Spread seasoned vinegar on the rice, then mix it with the rice. Fan the rice with a round fan until it renders luster.

***Do not mix seasoned vinegar with the rice in the inner pot.**



Cooking tips (as follows)

- Mix seasoned vinegar with the rice when it is still hot, so that seasoned vinegar can be fully blended in the rice.
- The reason why we use a sushi barrel is that excess water can be absorbed by it, so that rice will not get sticky.
- Replacing water with chilled kelp water for rice cooking can make rice more delicious.

SOUP

- 1 Prepare soup ingredients (such as pig bone, corn, carrots etc.), wash all ingredients and cut into small pieces, then put them into the inner pot, and add water no more than Max water line.
- 2 Close the lid, press the “MENU” button to select the “SOUP”, then press the “COOK” button, and wait for cooking to be completed.

CONGEE

- 1 Prepare rice and water. Place the rinsed rice into the inner pot and choose the appropriate water level according to rice amount.
Note: You may adjust the amount of water according to personal preference.
- 2 Close the lid, and press the “Menu” button to select “Congee”.
- 3 Start cooking Press the “COOK” button to enter the cooking state, and the cooking will be completed in designated time.

NOTE:

- The pre-set time is suggested not for more than 12 hours, otherwise the off-flavor may occur;
- To ensure the best cooking effect, the pre-set operation is not suggested for the “Crispy Rice”.

Clean & Care



Using an unclean cooker will result in bad odors, etc. Therefore, please keep it clean all the time. Always make sure to wipe off the water droplets from the steam port, inner pot /packing.



CAUTION

Unplug the cooker before cleaning and caring.
(It is a cause of burn wounds)

Please do not use the following materials

(They are causes of deformation, decoloration, corrosion, cracks scratches)

- Dish washers / dish dryers
- Detergents other than neutral detergent for kitchen use
- Benzene, thinner, alcohol, cleanser, bleaching agent
- Scrubbing brushes, melamine sponges which easily cause scratches

The inner lid is made from aluminum. It may decolorized by detergents used for dish washers.

The inner pot, the inner lid, the steam port, and scoop should be washed after each use.

The measuring cup should be washed with neutral dishwashing detergent. Adding seasonings in the pot without washing the inner lid after that, will result in rusting

Do not wet the cooker body, cooking heater, temperature sensor.

Wipe off dirt and foreign substances with a well-wrung cloth.

- Do not wash without taking it apart. Do not wet the operation parts and outer lid (cover lid). Do not pour water into the inner side of the cooker body.
- Do not pull the heat sink packing forcefully. (It does not come off)

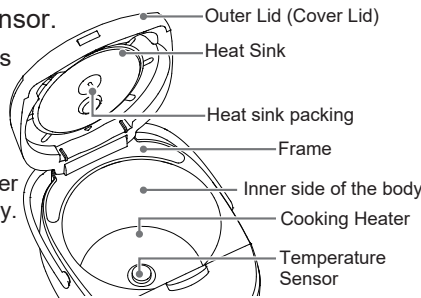

Use cotton buds to remove dirt, foreign substances from the air vent (at bottom of cooker body) and hook button gap.

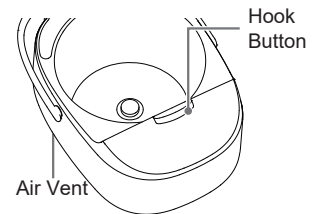

If there are any grains of cooked rice left at the cooking heater/temperature sensor, please rub gently with soft-sandpaper (approximately no. 600), and wipe off with a well-wrung cloth.

Steam Port

Each time of use

Remove by

pulling up to the top direction



Set the brim

to the hollow part and push down completely

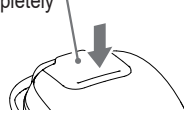

Open

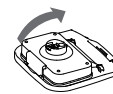

Close



Inner Lid

Each time of use

Remove by

pulling forward

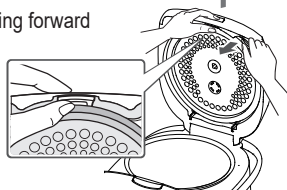

Attach

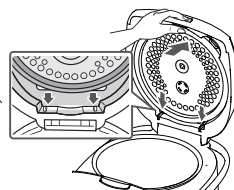

- ① Insert at the direction of the lower two shears.
- ② Press to make it fully attached.

- Without attaching the inner lid, the outer lid (cover-lid) cannot be closed completely (to prevent forgetting to attach the inner lid)

Cleaning by boiling (approximately once a week) Please also do whenever it smells unpleasant.

- 1 Put water in the inner pot (until it reaches the water level scale 2 for White Rice), and close the lid.
- 2 Select (White Rice) with "Menu" key, and press "COOK" key.
- 3 When it becomes "Keep-Warm operation", press "Cancel" key. When the cooker has cooled down, remove the inner lid, inner pot and steam port, wash and dry them.

- Do not put anything (for example. detergents, etc.) other than water.
- Do not consecutively clean by steam.
- Some smell may not be completely absent.

In Case of Problems

Before making repair requests, please investigate once more. If cannot investigate or take further action by yourself, please make an inquiry to Toshiba service center.

Trouble Cases		Causes / points of investigation
<p>The cooker doesn't power on. The rice does not cook. The cooked rice is tepid although being handled with "Keep-Warm" function. The rice is juicy. Key operation cannot be performed.</p>		<ul style="list-style-type: none"> Is the cooker unplugged or does the plug fall out of the outlet ? If the current time is displayed during the cooking or the "Keep Warm" operation, the cooker is in a power failure state and the plug is disconnected or the circuit breaker shuts down power.
Rice	<p>Soft Mushy, Sticky Clumping together Undelicious</p>	<ul style="list-style-type: none"> Please cook the rice with less water. When the rice has cooked, loosen it immediately and entirely. Please cook new rice with less water. Soaking beforehand will soften the texture of rice cooked with pre-programmed settings. Washing the rice grains forcefully or leaving it in a colander may cause it to get cracked and become mushy, sticky when cooked. Is it cooked with hot water or alkaline ionized water with pH 9 or higher ?
	<p>Hard Dry Undelicious</p>	<ul style="list-style-type: none"> Please cook the rice with more water. Please soak the rice grains before cooking. Was it cooked with mineral water which has high degree of hardness ?
	<p>Getting scorched ※ Getting a little burnt and turning to light brown is not a result of breakdown or failure</p>	<p>Rice gets scorched easily in the following cases:</p> <ul style="list-style-type: none"> When rice has not been washed enough. When soaking time is too long. For wash-free rice (Musenmai), rinsing 1 - 2 times can reduce scorch problems. When there are dirt or foreign substances stuck to the temperature sensor. When adding seasonings to rice cooked with several ingredients. When cooking germed brown rice, etc.
	<p>Undelicious, Not cooked well</p>	<ul style="list-style-type: none"> Do you cook rice while the cooker inner-side, inner-lid, etc. are still hot or warm? Please wait until their temperatures have cooled down to the same level of human body. In case of "Quick Cook" operation, the rice may be rather hard, or rather soft. Are there any foreign substances stuck to the temperature sensor, inner-lid packing, steam port, etc.? Is the inner pot deformed? Did you forget to attach the inner lid, steam port, etc.? Was there any power failure? Was the cooker unplugged ?
Rice kept warm	<p>Unpleasant odors ※ In case of having unpleasant odors, please clean by boiling and get it dried before the next use.</p>	<ul style="list-style-type: none"> Please check if "KEEP WARM" function has been used in the following ways: Using for a too long time. Using other programs than white rice. Using for cold rice. Using when a scoop is still put in the pot. Using for 12 hours or longer. Is the cooker body / inner lid / steam port dirty ? Please particularly remove the inner lid / the steam port to wash and use a clean cloth to wipe off water droplets every time after cooking. Has the rice been washed enough? Is the pre-programmed cooking time is too long? Is the rice left in the pot, with the "Keep Warm" mode off? (Pressing the key by mistake, or disconnecting because of a power failure) Did you leave the rice in the inner pot after turning off the "Keep Warm" operation? Please check the above details and change the "Keep Warm" settings.
	<p>Turning a different color Dry.</p>	<ul style="list-style-type: none"> Is there any foreign substances stuck to the inner lid packing, the brim of inner pot, or the frame of cooker body? Is there any foreign substances stuck to the temperature sensor or the outside of inner pot? Is the steam port attached properly? Is "Keep Warm" time too long? Has the rice been repeatedly reheated? "Keep Warm" operation with a small amount of rice may cause the rice at the bottom to get hard and dry, so please gather and pile the rice at the central part.

(continued)

Trouble Cases		Causes / Points of investigation
	Mushy, Sticky	<ul style="list-style-type: none"> ● Please cook rice with less water, then keep it warm. ● After the rice has cooked, loosen it immediately and entirely. ● Gather rice at the central part of the pot and sometimes mix together entirely, to prevent it from being left at the inner surface of inner pot.
Rice Cooking • Keeping warm	Steam leakage ※ Check after the rice has cooked	<ul style="list-style-type: none"> ● Are there any foreign substances stuck to the inner-lid packing, inner-pot brim, or on the cooker frame? ● Are there any scratches at the inner-lid packing? Are there any deformation of the inner lid / inner pot? ● Is the inner lid attached properly?
	Boiling over Spattering	<ul style="list-style-type: none"> ● Are there any problems of small amounts of rice, large amounts of water, insufficient rice washing? ● Did you make any mistake of porridge cooking menu ? ● Are there any foreign substances stuck to the temperature sensor? ● Is it dirty inside the steam port ? ● Are the inner lid, the steam port attached properly?
	Thin films appear at the inner pot.	<ul style="list-style-type: none"> ● Oblate-shaped films are sweet constituents (starch) of rice which have melt and dried. There is no abnormality in this case.
	Water droplets appear at the inner lid, inner pot, etc	<ul style="list-style-type: none"> ● Water droplets may appear at the inner lid, inner pot, etc., in order to prevent drying. There is no abnormality in this case.
	When opening the lid, water drips from the packing, etc.	<ul style="list-style-type: none"> ● When opening the lid, there may be some liquid dripping from the frame, etc., depending on lid opening times, room temperature, etc. ● Are there any foreign substances stuck to the temperature sensor/the outer side of inner pot ?
Pre-programmed settings	Cooking starts immediately	<ul style="list-style-type: none"> ● If pre-programmed times are within the time of the cooking menu, it will start cooking at once.
	Rice does not cook at the pre-programmed time	<ul style="list-style-type: none"> ● Rice may cook later by about 10 minutes. if the room temperature / water temperature is low, and the amount of water is large. ● Has the inner pot been put properly in the cooker, when setting the pre-programmed operation?
	Pre-programmed operation cannot be done.	<ul style="list-style-type: none"> ● Did you forget to set the cooker for pre-programmed operation, or forget to press "COOK" key or something like that ?
Operation • Indications	It is hard to close the lid The lid cannot be closed	<ul style="list-style-type: none"> ● Is the inner lid attached properly? In order to prevent forgetting to attach the inner lid, the outer lid cannot be closed completely without the inner lid attached. ● Are there any foreign substances stuck in the gap of hook button, etc.?
	Key operation cannot be done	<ul style="list-style-type: none"> ● Is the plug inserted ? Is the inner lid attached? ● While selecting "Food Preparation" course, such as <Cake>, the "TIMER" key is not accepted despite pressing it.
	The "COOK" lamp goes out The operation stops half way	<ul style="list-style-type: none"> ● If the "Cancel" key is pressed by mistake, or if a power failure lasts for a long period, the power will be cut off.
	The remaining cook time indicated is not the same as that of real cooking.	<ul style="list-style-type: none"> ● It is possible that the remaining cook time indicated may not be the same as that of real cooking. It is not because the cooker is out of order. The actual time results may vary depending on ingredients, room temperature, etc.
	The indicator of time spent in "Keep Warm" mode blinks	<ul style="list-style-type: none"> ● It indicates that the rice has been kept warm for a long period of time, so please stop it.

Trouble Cases	▶ Causes / Points of investigation
---------------	------------------------------------

Food Preparing	It takes a long time to prepare food. The setup time does not decrease.	<ul style="list-style-type: none"> The setup time starts from the "ready-to-cook" temperature. However, it needs some time for heating until the temperature gets ready for cooking. Therefore, real cooking times will be longer than setup times.
	The food is not well made.	<ul style="list-style-type: none"> Finished condition of cooked food may vary depending on ingredients and measuring methods, etc. Please check and confirm the cooking procedures and cooking times. The following factors may lead to cooking failure, steam leakage, or cause the lid not to close properly. Foreign substances stick to the temperature sensor. The inner pot is deformed. Cooked food is left in the pot. There was a power failure. The cooker connection plug was not inserted in the socket.
Others	It sounds when cooking.	<ul style="list-style-type: none"> [Tik] heat adjustment sound , [Chu] steaming sound. (It is not because of malfunctioning). [JuJu] sound of water droplets splattering and burning at the outer surface of inner pot Please wipe off water droplets at the outer surface of inner pot before putting it into the cooker.
	There is plastic smell.	<ul style="list-style-type: none"> At the beginning of use, there may be some unpleasant smell, but it will disappear little by little while using → if feeling worry, please clean it by boiling .
	There are scratches, dirt on the outer surface of inner pot.	<ul style="list-style-type: none"> After using, coated inner surface may get scratched or get dirty, but there will be no effect on cooking or warming quality.
	The circuit breaker is off , when cooking food.	<ul style="list-style-type: none"> If using the cooker with other electric appliances in the same time, power consumption may be overrated, causing the circuit breaker to cut off power. Please use an isolated outlet.

In case of a power failure

Please do in the same way as when the cooker is halfway unplugged, when the cooker connection plug falls out, or when the breaker cuts off power.

During pre-programmed cooking	<ul style="list-style-type: none"> After restoring from a power failure, the cooker will restore to the original state.
During rice cooking	
During keeping warm /	
During steam boiling	

※ If the power failure lasts for a long time, the rice may be not well cooked.

ERROR INDICATION

Anomaly self-checking

Display the cause of the abnormality network for repair or installation.

Please contact your local dealer or service

Indicat or state	Abnormal display	Possible Reason	Solutions
Light on	1 EE	Main thermistor (bottom sensor) open circuit	Pull out and re-connect the power cord, the display still shows same message, please send the cooker to your local after-sales service centre for maintenance.
Light on	2 EE	Main thermistor (bottom sensor) short circuit	
Light on	5 EE	Top lid sensor (handle thermistor) open circuit	
Light on	6 EE	Top lid sensor (handle thermistor) short circuit	
Light on	0 EE	Abnormal temperature system error	
Light on	8 EU	Communication error	
Flash	8 EU	Communication error	

Specifications

Model Name	Power Supply	Power Consumption (COOK)	Body Dimension	Body Weight	Frequency
RC-10DRNH	220-240V~	625-744W	L368*W271*H212(mm)	3.5kg	50/60Hz
RC-18DRNH		780-928W	L393*W287*H254(mm)	4.4kg	50/60Hz
RC-10DHNH	220-240V~	605-720W	L368*W271*H212(mm)	3.2kg	50/60Hz
RC-18DHNH		760-904W	L393*W287*H254(mm)	3.9kg	50/60Hz

