

TOSHIBA



**Toshiba Electric
Rice Cooker/Warmer**

(For household use)

Instruction Manual

Model

RC-10NMF

RC-18NMF

RC-10NMF E

RC-18NMF E

RC-10NMF EIS

RC-18NMF EIS

RC-10NMF I

RC-18NMF I

RC-10NMF IAU

RC-18NMF IAU

RC-10MM

RC-18MM

RC-10MME

RC-18MME

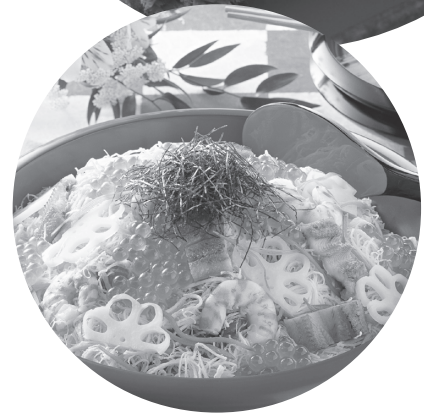

Safety caution

Caution

- Do not disassemble, repair or modify.
- Do not immerse the appliance in water.
- Do not attempt to use the metal articles, e.g. a pin or a wire, into the hole.
- Do not use when the power supply cord or the power plug is broken, or the power plug is loose.
- Do not directly touch the steam with your hand or face.
- When disconnecting, hold the power plug and pull it out without touching the power supply cord.
- Pull the power plug from the AC outlet when not in use.
- Do not place the appliance on the hot, soft, or unstable surface.
- Do not use the appliance near fire or water source.

Do not use any other inner pot except the provided one.

- Holding the power plug while retracting the power supply cord.
- Do not use the appliance in the place which is about 10 cm near the wall, on the paper, clothes, a carpet, or a plastic bag, etc. and the place exposed to direct sunlight.
- Wipe away the drops of water and the foreign matter after use.
- Do not cover the steam vent with the cloth or place anything while operating.
- Do not use the metal spatula, metal-scrubbing brush, nylon-scrubbing brush, and cleanser with the inner pot.
- Do not use the appliance near the flammable place or an electromagnetic wave adjuster.
- This appliance is not intended for use by young children or infirmed persons unless they have been adequately supervised by a responsible person to ensure they can use the appliance safely.
- Do not allow the children to use, keep it out of reach from them.
- If the power plug or its polar is dusty, wipe it away with the dry cloth.
- Fully fit the power plug into the socket.
- Do not open the lid while cooking.
- Do not break/scratch, bend, pull, twist, the power supply cord.
- Do not place the appliance near the heating source.
- Do not put the heavy objects, pinch, or modify the power supply cord.
- Do not connect the power supply cord while your hand is wet.

Do not add the following items.

- (Otherwise, the cooker may boil over or you may get burned.)
- Beans, noodles, baking soda, roux such as curry, stew, etc., a large amount of oil, and milk or other foods that are likely to get frothy that easily bubble.
 - Green leaves, plastic wrap, aluminum foil, cooking sheet, scum removing sheets and other items that easily float.

Do not add ingredients, seasonings and water that exceed the water level scale of the inner pot.

(Otherwise, the cooker may boil over or you may get burned.)

- Right after use or while using, do not touch the hot part (e.g. the inner part of the outer lid, a heating plate, a steam vent, or the inner pot)
- Do not use the appliance near the wall or the furniture.
- Do not touch the hook button while moving the appliance.
- Do not move the appliance while cooking.
- Do not warm rice with the spatula inside inner pot.
- Do not cooking if the inner pot is not inside the appliance.
- Unplug the power cord before cleaning the appliance.
- Do not warm rice over 30 hours. It is greater than standard of warming time, the indicator flashing.
- This appliance is not intended for use by persons (including children) with reduced physical, sensory or mental capabilities, or lack of experience and knowledge, unless they have been given supervision or instruction concerning use of the appliance by a person responsible for their safety.
- Children should be supervised to ensure that they do not play with the appliance.

This appliance is intended to be used in household and similar applications such as:

- staff kitchen areas in shops, offices and other working environments;
- farm houses;
- by clients in hotels, motels and other residential type environment;
- bed and breakfast type environment.

If the power supply cord is damaged, it must be replaced by the manufacturer, its service agent or similarly qualified persons in order to avoid a hazard.

The boiling water may overflow from adjusting the amount of water exceed maximum water level scale for cooking.

A warning of potential injury from misuse.

A warning to avoid spillage on the connector.

The heating element surface is subject to residual heat after use.

The appliance inlet must be dried before the appliance is used again.

Insert the power plug (main body side) into the plug insertion hole on the rear side of the main body.





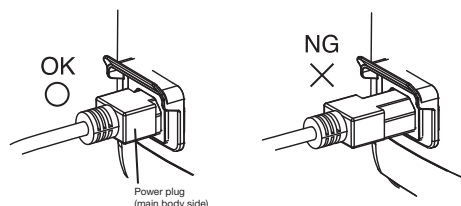



Do not expose the power plug or other electrical components to hot steam.

Be especially careful when placing and using the appliance on the kitchen counter, to avoid steam attached to the plug and cause electric shock or fire.



 Insert the power plug into the hole completely.

Important Document on Safety Precaution

	 Indicates the forbidden operation.
	 Indicates the information which should be followed strictly.
<h2>Safety Warning</h2>	
 <p>Forbidden</p>	<p>Do not disassemble, repair, fix, or modify the product (unless indicated in the operation manual). Do not pull or insert the electric plug and the magnetic plug with wet hands. Do not touch the product, cable, or electric plug with wet hands. Do not operate the product if the cable or electric plug is damage, or the electric plug is inserted improperly. Do not modify or repair the cable and electric plug or use other cables which are not included with the product (except the ground wire). Do not bend, break, twist, or pull the cable while the product is operating. Do not place the product or other objects on the cable or pinch the electric plug or the cable. Do not place the electric plug or cable in the place with high temperature, flooded water, and high humidity or touch it with sharp-edge object. Do not connect the product to the power source which is not specified in the operation manual. Do not expose the product to water. Do not use the adaptor plug in order to fit in the power outlet. Do not use the power outlet together with other electric appliances.</p>
<h2>Safety Caution</h2>	
	<p>Insert the electric plug into the power outlet as far as the base of the electric plug. To unplug, hold the body of the electric plug and pull it off. Wipe dust or moisture at the electric plug's pins thoroughly before inserting it into the power outlet. Pull the electric plug out of the power outlet when the product is not in use. Pull the electric plug out of the power outlet before maintaining or cleaning the product.</p>
<h2>Caution for Safety Installation</h2>	
	<p>Do not bring any flammable object, hazardous object, chemicals, or flammable gas near or in the product. Do not install the product near the naked flame, wet area, or hot and high humidity area. Do not install the product in the high electromagnetic area. Do not install the product in the area within a child's reach. Do not install the product on the slant or insecure floor. Connect the ground wire at the specified position on the product.</p>
<h2>Caution for Safety Operation</h2>	
	<p>Read the operation manual carefully and thoroughly before using the product. Always inspect that the product is in a good operating condition before using by following the recommendation in the instruction manual. Remove all packing materials. Do not allow children to use the product alone. Do not place any object on the product or cover the product while in use (unless indicated in the operation manual). Do not touch any hot or cold parts of the product. Do not use "Max" water level scale for cook rice. It may cause burn injury.</p> 

Part names

Main Body

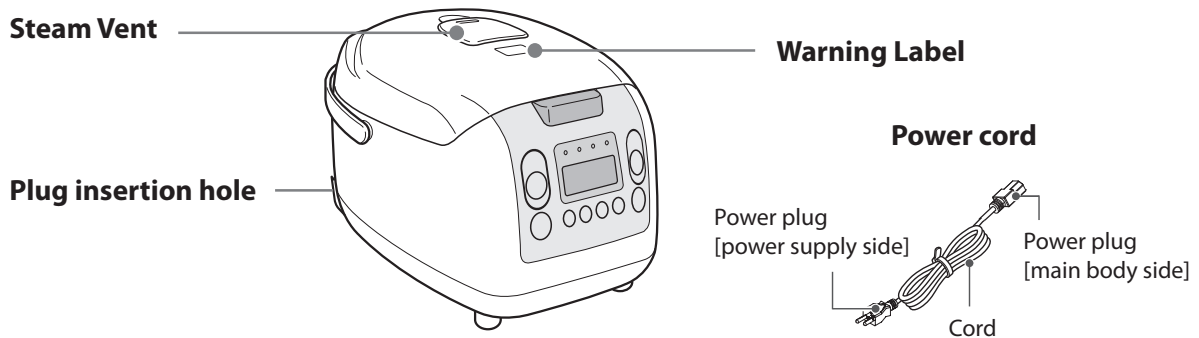
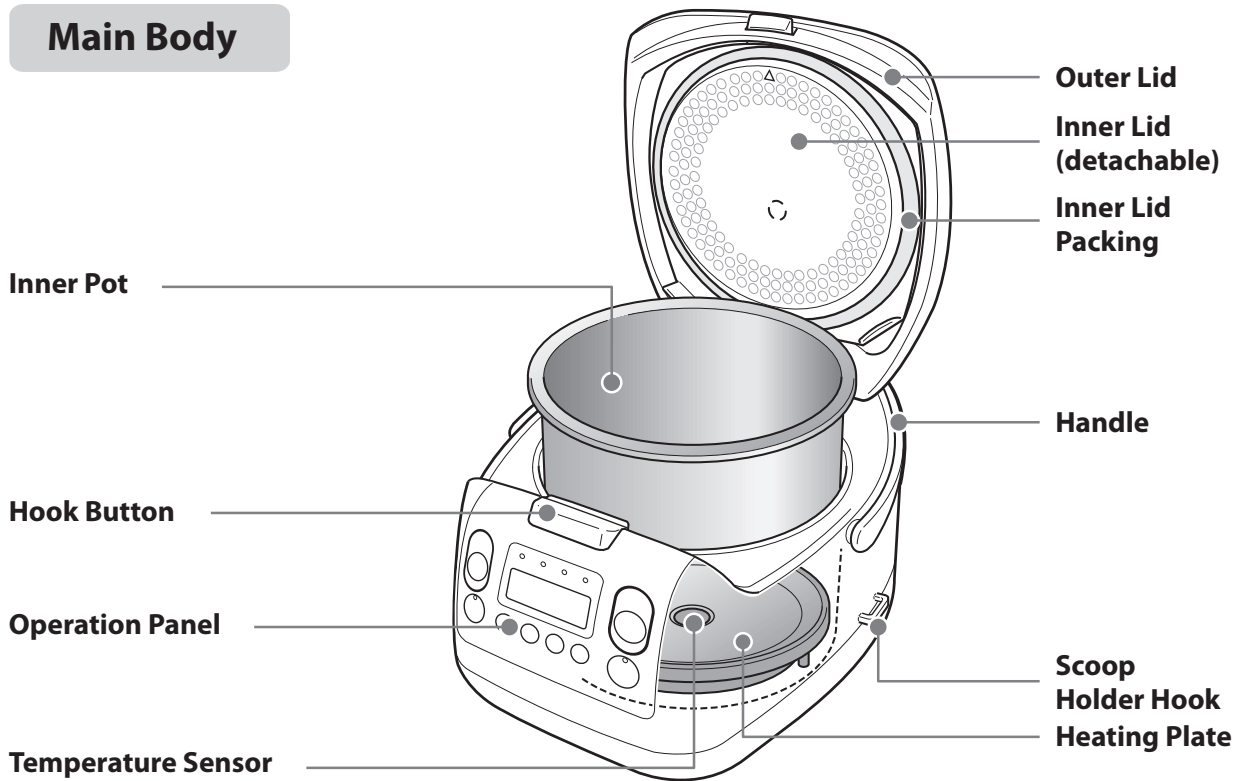

Accessories



Measuring Cup
(Approx. 180 ml.)



Scoop holder
Insert it in the hook on the cooker's side.



Scoop

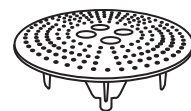

Food Steamer

Part names

Control Panel

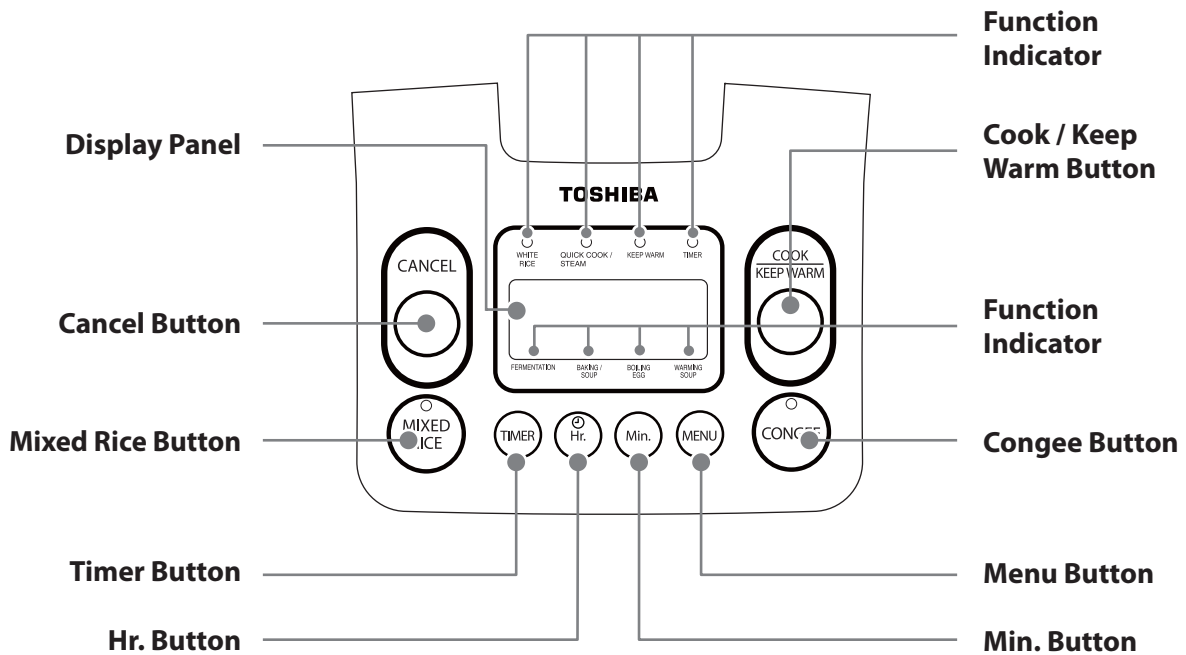

Rice Cooker - Cooking Time

Cooking	Button	Water Level Scale	Type 1.0 L		Type 1.8 L	
			Amount of Rice (Cup)	Cooking Time (Minutes)	Amount of Rice (Cup)	Cooking Time (Minutes)
White Rice	COOK	White Rice	1-5.5	38-51	2-10	42-54
White Rice (Rapid Cook)	COOK (Press twice)	White Rice	1-5.5	32-45	2-10	34-52
Mixed Rice	MIXED RICE	Mixed Rice	1-5.5	62-73	2-10	65-79
Glutinous Rice	COOK	Glutinous Rice	1-3	37-46	2-6	39-49
Congee	CONGEE	Congee	0.5-1	58-68	0.5-1.5	59-72

(MODEL : RC-10NMF, RC-18NMF, RC-10NMF1, RC-18NMF1, RC-10NMF2, RC-18NMF2, RC-10NMF2S, RC-18NMF2S)

"Max" water level scale for boil water only. Please do not fill water over this level scale.

How to install Earth lead wire

(Model RC-10NMF, RC-18NMF, RC-10NMF, RC-18NMF, RC-10MM, RC-18MM, RC-10MME, RC-18MME)

1. Remove Screw, Spring washer and Flat washer on Earth connecting plate.

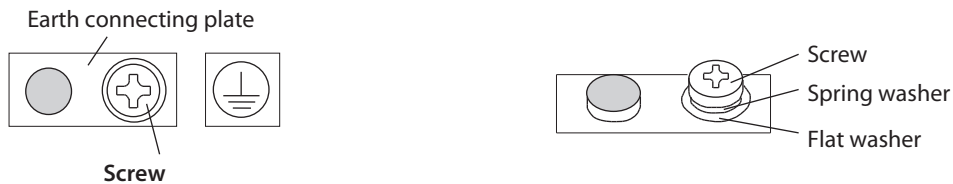

2. Set Earth lead wire on Earth connecting plate then put Flat washer and Spring washer respectively on Earth lead wire and fixing screw tightly.

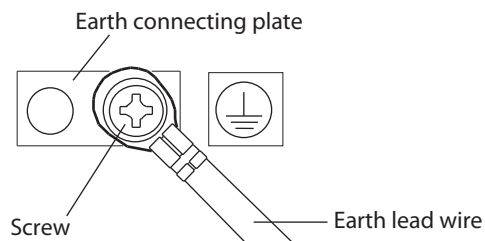

Steam Stand

How to pour water

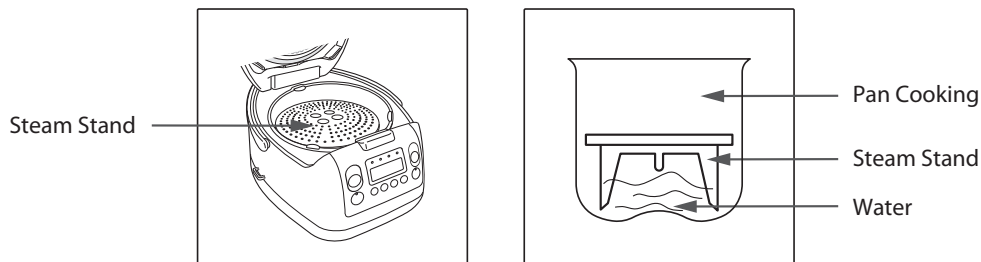

Rice Cooker	Water level	
	Minimum	Maximum
RC-10	250 ml.(approximately 1.5 cup of Measuring cup).	900 ml.(approximately 5 cup of Measuring cup).
RC-18	350 ml.(approximately 2 cup of Measuring cup).	1000 ml.(approximately 6 cup of Measuring cup).

How to use

Can use function COOK or RAPID cook for steaming.

If want to cancel steaming function before operation finish, push CANCEL button once.

Remark

After operation finish the unit change to warming function.

If want to start steaming function new one, push COOK button for COOK or RAPID COOK function again.

Be careful the water level inside pan cooking before steaming process again.

Preparation

1 Measure the rice with the measuring cup provided.

- A flat-filled cup of rice is approx. 180 ml.



2 Quickly rinse the rice until the water becomes clear.

- 1 Firstly, fill enough water and mix the rice and water and rinse the rice, then pour out the water immediately.
- 2 Scrub and rinse the rice repeatedly with water until the water becomes reasonably clear.

◆ The rice can be rinsed in the inner pot.

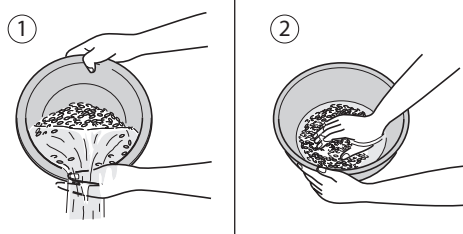

3 Fill in or pour out water according to the water level scale of the cooking means you want.

- Please level the surface of the rice and fill in or pour out water on a flat surface.
- Fill in or pour out water according to the cooking means and the cups of the rice. And adjust the amount of water according to the type of the rice and your personal taste.

◆ Example: Cooking 3 cups of rice.

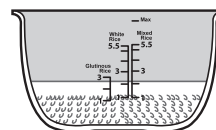

4 Place the inner pot inside the body and close the outer lid.

- Please wipe away the water drops and dirt on the outer of the inner pot, the temperature sensor, the cooking heating plate and the inner lid.
- In order to make the inner pot close contact the cooking heating plate, please turn the inner pot twice or three times in the directions as shown by the arrows.
- Make sure that the steam vent works properly.

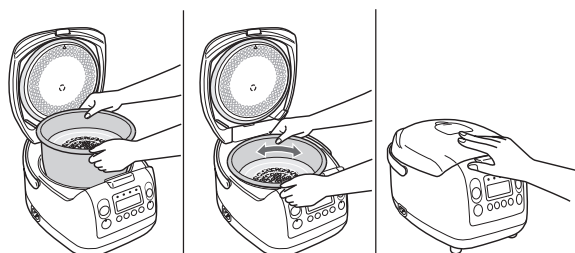

5 Fit the power plug into the socket.

- Please hold the plug while fit or remove the power plug into the socket.

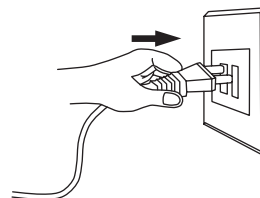

6 Make sure that the time on the display window was set precisely with the present time.

How to adjust the clock

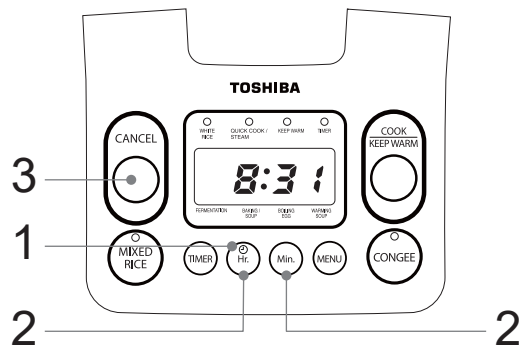

Example: To adjust the current time to 8:31 a.m.

Procedure

- 1 Hold down the Hrs button for more than 1 second.**

▼ The clock display flashes.



- 2 Press the Hrs button to adjust the Hour readings and press the Min button to adjust the Minute readings.**

- For Min button, if the button is held down and not released the setting pace will be 10 minutes.

▼ The clock display flashes.

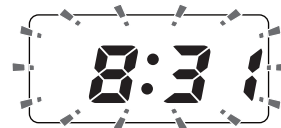

- 3 Press the CANCEL button.**
Clock adjustment is complete and the time counts.

▼ The clock display unflashes.



NOTE

- The lithium battery installed inside the cooker will last for 4-5 years at the room temperature with the power plug connected. With the lithium battery, the current time can still display and the set time is still stored in the memory even though the power plug is disconnected. If the display lights off or 0:00 flashes on the display, it means that the battery expired.

Even if the current time and the set time disappear, the cooker can cook rice as usual.

(Pressing CANCEL button will stop the flashing of 0:00.)

Never drop the lithium battery into water or charge, disassemble or heat it.

- The clock cannot be set during COOK, WARM and TIMER mode.
- The clock cannot be set if the power plugs (at the power supply side and the body side) are not fully inserted.
- While the clock display is flashing, the clock will not go ahead.
- Time display is 24 Hrs.
- In the operation of the Hrs button, at 0:00 the sound "beep luo luo" will be heard and at 12:00 the sound "beep luo luo" will be heard twice. In the operation of the Min button, the sound "beep luo luo" will be heard at 00 minute and the long "beepee" sound will be heard at 10, 20, 30, 40 and 50 minutes.

How to preset time

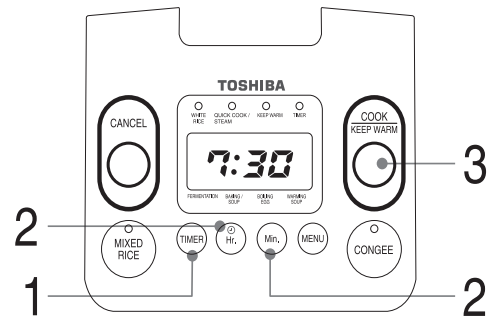



Example: To set the timer for preset time to finish at 7:30 a.m.

Procedure



- 1 Press the TIMER button.**

 - ▼ The TIMER indicator flashing.
 - ▼ The last preset timer flashing.



- 2 Press the Hrs button and Min button to adjust the preset time.**

 - If the preset time is the same as the last one, this step can be omitted.
 - Time display is 24 Hrs.
 - Minute button will be added every 10 minutes.
 - ▼ The TIMER indicator flashing.
 - ▼ The preset time in setting.

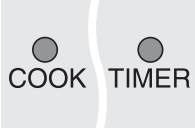

- 3 Press the COOK button.**

 - For cooking as cooking menu selected.
 - During preset time, hold down the Hrs button to display the current time.
 - ▼ The COOK indicator lights up. The TIMER indicator lights up.
 - ▼ The preset time for this time.

The timer is set up successfully.

Cooking Done

- ▼ The "Beep" sounds for 5 times
 - ▼ The KEEP WARM indicator lights up.
 - ▼ The time that has elapsed for warming.
(h : hour)
- 







Warming

How to cook (White Rice, Mixed Rice, Quick Cook and Congee)

NOTE

■ For rapid cook only.

- Rapid cook refers to the cooking method that first shortens the cooking time. Generally, the rice cooked by this method tastes firmer and has a little water on its surface.
- Use this method when the amount of rice is less than 4 cups for Type 1.0L and 6 cups for Type 1.8L.

Procedure	<p>Press the COOK button once.</p> <ul style="list-style-type: none"> • For rapid cook, please press this button twice. • In rapid cook, the rapid Indicator will light up. 	<p>▼ The COOK indicator lights up.</p> 	<p>▼ Current time</p> 
	<p><u>cooking</u></p> <ul style="list-style-type: none"> • In rapid cook, the rapid Indicator will flash. • In rapid cook, the time will show 8 minutes ahead. 	<p>▼ The COOK indicator is flashing.</p> 	<p>▼ The time (in minutes) remains for cooking.</p> 
	<p><u>Steaming</u></p>		
Cooking Done		<p>After "Beep" sounds for 5 times</p> <p>▼ The KEEP WARM indicator will light up.</p> 	<p>▼ The time that has elapsed for warming. (h : hour)</p> 
	<p><u>Warming</u></p>		

How to cook (Fermentation, Baking/Soup, Boiling Egg and Warming Soup)

Example : Ferment cooking

Procedure

1 Select (Fermentation) press button

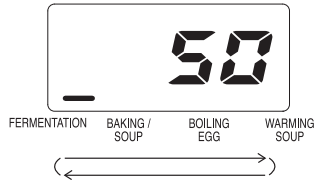

- Select cooking menu by MENU button.
- COOK indicator will flashing.
- During press button MENU, screen displays menu () running change will occur.

2 Set time cooking by press button

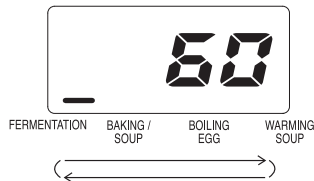

- If the Min button is held down and not released the time setting will be added 10 minutes.

(Sample time setting 60 minutes)

3 Start (Cooking) press button



▼ Screen displays cooking

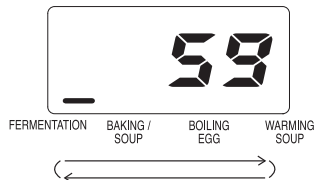

- The COOK indicator light up.
- The remaining time for cooking show 59 minutes.

Cooking Done

When cooking is finished, it sounds (Beep) for 5 times.

The machine will be cut off automatically.

How to keep warm

Cooked rice will run into warming automatically.

Start warming

Keep warm function

Press button  to warming



- The keep warm and reheat indicator will light up.
- Screen displays running time.
(h : hour)

Stop warming

Stop

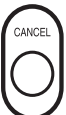
Press button  to cancel keep warm function.

- The keep warm indicator will light off.

NOTE

- During warming or reheat function press hour button, screen will display present time.
- Do not warm and leave scoop in pot. Because it causes smell or color changeable.
- Do not warm rice over 30 hours. It is greater than standard of warming time, the indicator flashing and shown 30 hours.



- Use warming menu for rice which is less than half of pot. If rice is over, heat is not suitable.
- Rice is extremely hard, pouring water for 1-2 teaspoon can solve this problem. Rice will be soft.
- Do not heat cold rice because heat is not suitable.

Simple Round Bread

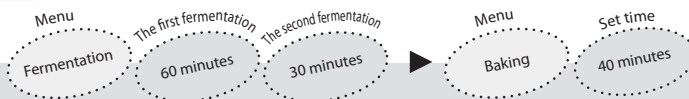

Ingredient

- Wheat flour.....100 g
- Dry yeast.....2 g
- Sugar.....5 g
- Salt.....2 g
- Milk.....60 ml
- Butter.....10 g



How to cooking

1 Put the ingredients are gathered in the bowl.

2 Add milk and butter (Melted to 40 degree) and mixed by a ladle then put on the table and knead by hand as well.



3 After the dough is rounded put in the inner pot with a few vegetable oil (It becomes easy to ferment when rounded dough is well heat).



4 Push the MENU button to select Fermentation cooking (The first fermentation) set the cooking time 60 minutes and push COOK button.



5 After the first fermentation is completed open the lid and swollen the dough about 2 minutes.

6 Piercing to center of the dough and push down to deflate for gas pulling out.



7 Take out the dough, round it again and put in the inner pot with a few vegetable oil.

8 Push the MENU button to select Fermentation cooking (The second fermentation) set the cooking time 30 minutes and push COOK button.

9 After the second fermentation is completed open the lid and ferment condition testing by finger test.

NOTE

- The fermentation is shortly.
Push the finger to the dough, it becomes to stiff.
Please increase cooking time of the fermentation for next time.
- The fermentation is excessively.
Push the finger to the dough, it becomes to wither.
Please decrease cooking time of the fermentation for next time.

10 Remove the steam vent then push the MENU button to select Baking/Soup set the cooking time 40 minutes and push COOK button.

11 When baking finished, take Simple Round Bread out with a ladle.

Butter Cake

Ingredient

- Butter Cake flour mix.....400 g
- Egg 6 eggs
- Milk.....60 ml
- Butter220 g



Menu

Baking

Set time

40 minutes

How to cooking

1 Put the ingredients are gathered in the bowl.

2 Beating with the whisk by firmly.



3 Add milk and butter (Melted to 40 degree) and mixed by a ladle.



4 After the dough is mixed put Butter Cake flour mixed about 200 ml in the inner pot with a few vegetable oil.

5 Push the MENU button to select Baking/Soup set the cooking time 40 minutes and push COOK button.

6 When baking finished, take Butter Cake out with a ladle.

Soft-Boiled Egg

Ingredient

- Egg 2-6
- Water.....500 ml



Menu

Soft-Boiled Egg

Set time

25 minutes

How to cooking

1 Put the egg in the inner pot and fill in the water about 500 ml.

2 Push the MENU button to select Boiling Egg, set the cooking time 25 minutes and push COOK button.

3 When boiling finished, take egg out immediately with a ladle and remove the husk politely. Put it in the cup and pour with mixed sauce.

Maintenance and Specification

Maintenance

How to detach

1 Hold the holders at the bottom edges of the inner gasket and pull it towards you.

- Do not detach the inner gasket if it is not necessary because it may be loose.



How to reassemble

1 Fit the upper part of the inner gasket to the slot on the outer lid.

- Hold the holders and lift the inner gasket up following the direction of the > mark fit it to reassemble.
- Reassemble only when the inner gasket is completely dry.

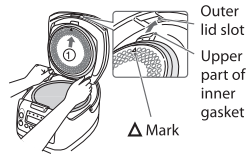

2 Push the holders to the outer lid firmly.

- Ensure the inner gasket fit firmly to the outer lid. If it does not, the outer lid cannot be closed.

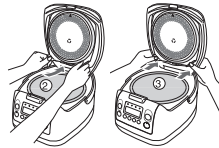

- Please clean the inner gasket after cooking the rice.
- Do not bend or twist the inner gasket. It may not fit to the outer lid or the steam may leak out.

Steam Vent

How to detach

1 Turn the steam vent cap following the arrow direction.

- Open the cap by turning it upwards.

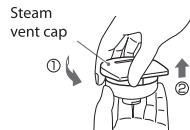

How to reassemble

2 Close the cap by aligning the mark with the groove, then turn the cap following the arrow direction.

- Turn the cap until the clicking sound is heard.

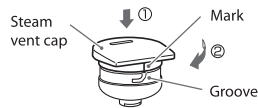

After cooking rice

Clean them with a sponge and mild dish detergent.

Clean it with a sponge and mild dish detergent.

- Clean the inner gasket as well.

Wash the steam vent thoroughly.

Wipe away the dirt and stain with a damp cloth.

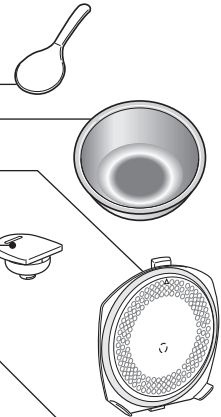

When dirty

Wipe away the dirt and stain with a damp cloth.

- Do not wash the pot body thoroughly.
- Do not wet.
- Do not wet the control panel and the outer lid.
- Do not pour the water directly to the pot.

If there is some grains stuck on the heating plate firmly, rub it off with fine sandpaper (No. 600).

Remove some grains of rice with a cotton bud.

Remove some dirt with a cotton bud.

Caution : To prevent damage to the appliance do not use alkaline cleaning agents when cleaning, use a soft cloth and mild detergent.

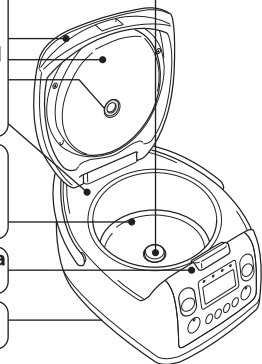

Specifications

Model	Power Supply	Power Consumption (W)	Dimension (Cm)			Weight (Kg)
			Width	Depth	Height	
RC-10NMF1	220- 240 V ~ 50-60 Hz	560	25.5	32.8	21.5	3.7
RC-10NMF1AU						
RC-18NMF1		750	28.0	35.2	24.9	4.5
RC-18NMF1AU						
RC-10NMF	220 V ~ 50 Hz	560	25.5	32.8	21.5	3.7
RC-10NMF E						
RC-10NM		680	28.0	35.2	24.9	4.5
RC-10MME						
RC-18NMF	230V ~ 50 Hz	560	25.5	32.9	21.5	3.7
RC-18NMF E						
RC-18NM		750	28	35.2	24.9	4.5
RC-18MME						

Part names and Functions

(Model RC-10NMF1, RC-18NMF1, RC-10NMF1AU, RC-18NMF1AU, RC-10NMF1EIS, RC-18NMF1EIS)

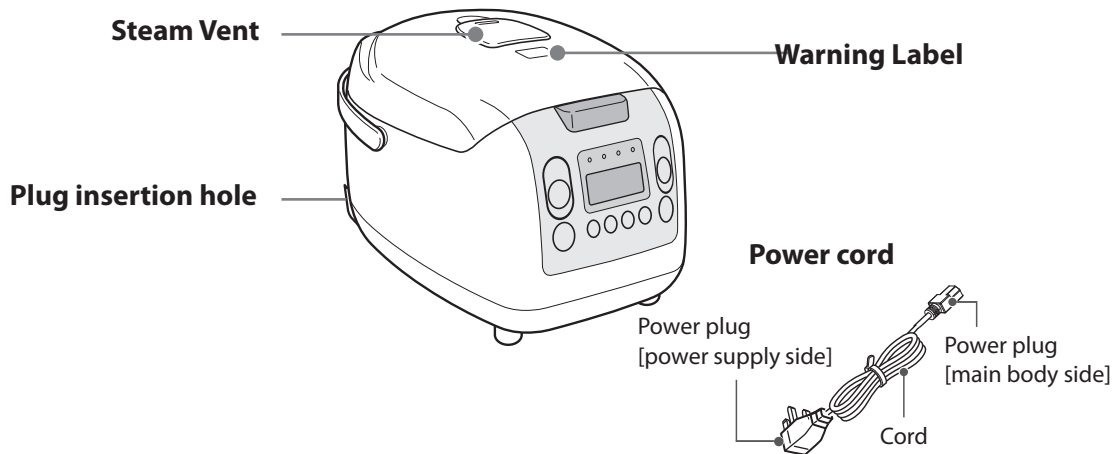
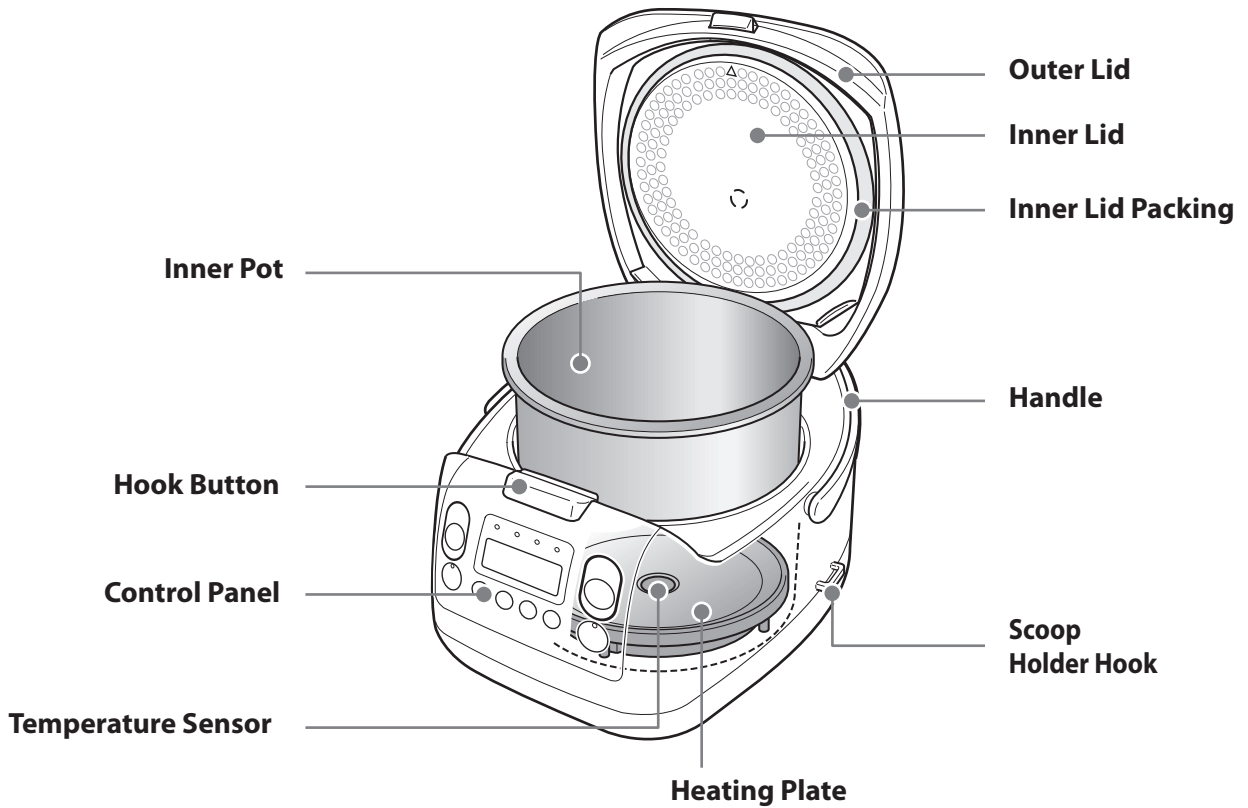

Regarding the Power cord.
For the figure, the Power cord is 3 pins plug for grounded socket version.

If the supply cord is damaged, it must be replaced by a special cord or assembly available from the manufacturer or its service agent.