

用戶手冊

空氣炸鍋

AF-52CS1TRHK(H)

TOSHIBA



目錄

| | |
|-----------------|----|
| 溫馨提示..... | 3 |
| 安全注意事項..... | 4 |
| 零件名稱..... | 9 |
| 使用前清洗..... | 10 |
| 操作部分..... | 10 |
| 使用前清洗..... | 11 |
| 使用方法..... | 11 |
| 安全使用說明..... | 13 |
| 紙杯蛋糕製作方法..... | 15 |
| 調整烹飪時間和溫度..... | 16 |
| 清潔和保養..... | 17 |
| 故障診斷..... | 19 |
| 出現問題時的處理方法..... | 20 |
| 螢幕顯示..... | 21 |
| 產品規格..... | 21 |

溫馨提示

只可使用220-240V交流電。

請勿用在除交流電220-240V以外的電源插座中使用。

感謝您購買東芝烤箱（空氣炸鍋）。

- 本產品僅作家用。（不能作為商業產品使用）。
- 請仔細閱讀本使用說明書，確保正確安全地使用本產品。
- 閱讀後，請務必將本使用說明書保存在方便取閱之處。
- 確保將本使用說明書存放在安全的地方。

請仔細閱讀並將其保存在安全地方，這點非常重要。

為確保正確且安全地使用本產品，請務必仔細閱讀“安全注意事項”部分（第4至8頁）。

安全注意事項

為防止對使用者或他造成傷害或財產損失，安全正確地使用本產品，以下對一些重要內容進行說明。

請在充分瞭解以下內容的情況下閱讀本文本，務必遵守所述安全注意事項。

- 對使用時不遵守說明事項產生的危害或損壞程度，進行分類說明。



警告

可能引起嚴重傷害或者有死亡的內容。



注意

可能發生“輕傷”或“房屋、財產等損失”的內容。

- 對應遵守內容的分類說明。



表示“禁止”的內容。



表示“遵守指示”的內容。



表示“希望注意”的內容。



警告

為防止受傷、燒傷、觸電、漏電、火災和損壞房屋的情況發生



以下人士請勿使用本產品：

- 嬰幼兒
- 身體、感官或智力不健全人士
- 缺乏經驗和知識的人士

請在嬰幼兒無法觸及的地方使用本設備，請勿讓兒童將本產品作為玩具使用。



請勿將本產品用於本手冊記之外的用途

- 則可能會引起火災、燙傷、受傷或觸電。



發生異常、故障時請立即停止使用本產品

本產品發生異常、故障時，請立即停止使用

立即將電源插頭拔出，並諮詢購買商家（異常和故障舉例）

- 電源線或插頭異常發熱。
- 電源線損壞或觸摸電源線時出現間歇性斷電。
- 本體變形或發燙。
- 本體冒煙或發出焦味。
- 本體破裂、鬆動或咯咯作響。
- 烹飪時沒有空氣從通氣孔出來。

安全注意事項



禁止拆解

請勿進行拆解、修理或改造

如需進行產品維修或更換零件，請到制造商指定的專業維修網點。以免因維修不當或配件選用不當帶來使用隱患。



禁止拆解



切勿用水清洗本體，電源插頭或電源線；請勿讓機體沾上水或向本體澆水請勿將水倒入本體內部。

禁止用水
沖洗

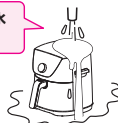

請勿在本體底部的通氣孔內插入異物

如大頭針和鐵絲等金屬物，以免導致觸電。

請勿放入
異物



在使用過程中，產品外表面會發燙，請不要觸摸發燙部位，也不要將手或臉靠近出風口，而應使用主體把手或炸桶把手；如果在發燙時必須握住炸桶，請保護好自己，以免燙傷。

操作時只觸摸操作介面，不要將手伸入爐腔內，以免燙傷。

正確使用電源插頭、電源線和電源插座



如果電源插頭和電源線破損或電源插座鬆動，請勿使用該產品。

電源線插頭上的任何灰塵或水跡應及時清理，以免造成火災，觸電或短路；務必使用專用電源線；如果電源線損壞，請聯繫製造商、其維修部門或類似部門的專業人士進行更換，以避免產生危險。

請勿損壞電源插頭或電源線

請勿強行彎折電源線，使其線靠近高溫部位（明火、烤爐等），捆綁通電，在上面放置重物，以免因電源線斷裂而引起火災或觸電。



手濕時禁止
觸碰

請勿用濕手拔插電源插頭

在拔掉電源插頭之前，請確保您的手是乾的。



單獨使用220-240V交流電、額定電流為10A以上的電源插座

如與其他電器合用插座，可能會發生異常並引起火災以及其他危害。

如需使用延長電源線，請單獨使用額定電流為10A以上的電源插座。

安全注意事項



使用時，請確保電源插頭完全插入。當不使用產品或外出時，務必要拔掉電源線，以免發生故障或危險。

小心請勿絆倒或勾到使用中的電源線

可能會引起受傷或因電源線破損而引起火災或觸電。

確保使用確實已接地的電源插座

本產品的電源插頭只能插入接地的電源插座。若未完全接地，可能會因故障或漏電而引起觸電。

定期去除電源插頭上的灰塵

如灰塵等積聚，就會產生濕氣等，絕緣性會變得不好，可能會引起火災。請使用乾布擦掉。



本產品僅適合室內使用

產品周圍應留出足夠的空間，與其他物品間保持30釐米以上的距離，確保周圍沒有可燃物，如桌布和窗簾，並且表面不能覆蓋任何物品。

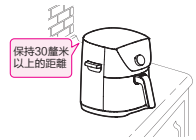

操作過程中，請勿移動或搖晃產品，並使電源線或電源插頭遠離出口；在移動產品之前，請在主體冷卻後拔掉電源線。



在產品工作之前，請檢查烤盤/炸桶是否放置到位，以免發生故障。

在炸桶放入之前，不要啟動本產品。



工作過程中，請勿用布等遮蓋出口，以免引起事故或造成產品損壞。

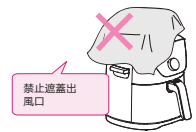

請勿使用非專用炸桶或變形後的炸桶。

以免因過熱或故障導致燙傷或受傷。



一些重要零部件，如保險絲等維修不當或私自短接可能使產品保護失效，導致過熱或火災。

安全注意事項



使用過程中或烹飪剛結束時，切勿觸摸高溫部件

本體溫度很高，特別是排風口、炸桶、底部發熱盤和防護網等金屬部件，請務必不要觸摸，以免燙傷。

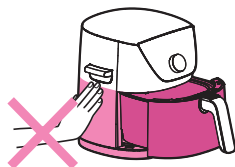

一些重要零部件，如保險絲等維修不當或私自短接可能使產品保護失效，導致過熱或火災。



不得將下列物品放入產品中烘烤，如：紙類、塑膠或易燃物品等。



切勿讓兒童單獨操作

請勿讓嬰幼兒接觸到本產品，以免發生觸電和燒傷等危險事故。



嚴禁在電磁爐上使用

以免損壞電磁爐或造成本產品故障。



禁止在本產品上方堆放其他物品或重物。



工作過程中，請勿長時間遠離本產品。

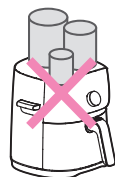

本產品不能在外接定時器或獨立的遙控控制系統的方式下運行。

如果出現故障，請務必停止使用本產品，並立即聯繫我們的維修部門。

裝有心臟起搏器的人士或助聽器、植入耳蝸的使用者在使用本產品時，請諮詢授權醫療人員並參考醫療設備說明書。

產品必須在平穩、耐熱臺面上使用，以免產品損壞或發生意外。



在將電源插頭從電源插座上斷開時，請握住電源插頭並將其拔出。

否則可能會導致因觸電或短路而發生火災。



在清潔時，或在產品不使用或外出時，請務必要拔掉電源線，以免發生故障或危險。

安全注意事項

請注意：

請勿放在陽光直射或油污飛濺的地方。

否則可能會導致本產品變形或變色。

當拿起炸桶提手或炸籃時

不要按提手上的收回按鈕，以免炸桶掉落。要取出炸籃，把它放在一個穩定的桌子上，按把手上的按鈕取出。

清潔本體和本體周圍

建議在每次使用後清理任何異物，如殘留在炸桶或炸籃上的食物殘渣；清理之前，請先關閉電源並確保產品已經冷卻。

切勿用硬物敲擊炸桶或將炸桶掉落在硬物上

否則可能會導致內膽外側損壞和變形。

切勿觸摸可移動的部件，以防夾傷。

烹飪時切勿放入過多食物

否則可能會影響烹飪效果，並使食物接觸到其他加熱部件，從而造成火災或人身傷害。

請勿使用大量的食用油烹飪。

高溫和熱空氣可能會導致油煙或火災等危險。

切勿將炸桶放在煤氣灶、或電磁爐上或放入微波爐中。

否則可能會發生變形、變色或故障。

切勿損壞設備表面的含氟聚合物塗層

否則可能會導致氟聚合物塗層剝落。

切勿將炸桶作為存儲容器使用。

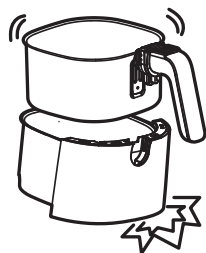

■ 產品正常工作的海拔高度範圍為0-2000米。



標有此符號的位置：

本產品工作過程中，表面非常熱，並且在工作過程中還會變熱。

■ 首次使用需在200° C溫度下乾燒10分鐘，乾燒過程中可能會出現少費白煙或異味，屬於正常現象，請勿驚慌。

■ 如產品圖片與實物不一致，請以產品實物為準。

■ 請妥善保管好說明書，以備日後參考。

零件名稱

■ 首次使用前，請清洗炸桶和炸籃，並在每次使用後清除食物殘渣。

■ 由於產品的外觀存在差異，以下圖片僅供參考，請以實物為準。

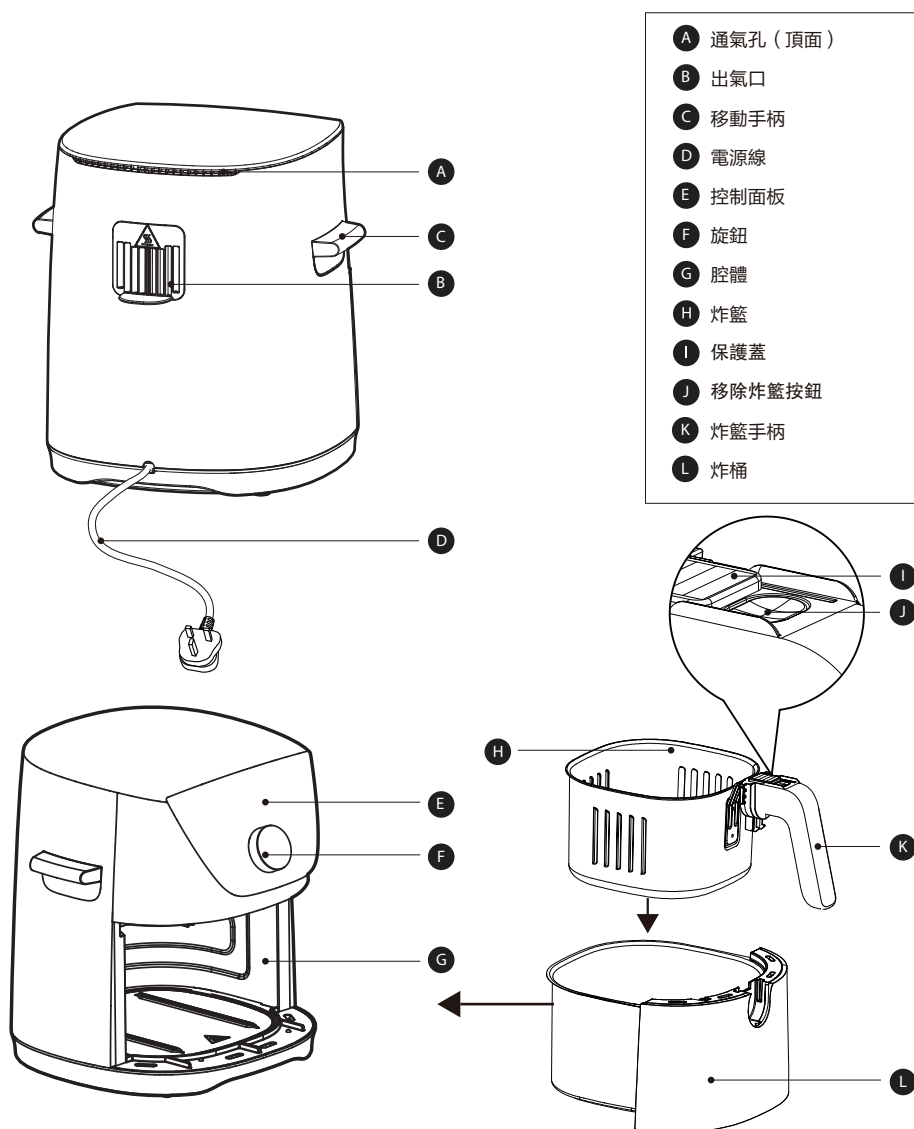

使用前清洗

清洗炸桶和炸籃

1 使用前用水沖洗炸桶、炸籃。

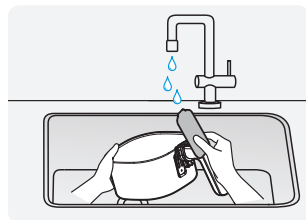

2 清洗後用乾淨的軟布擦乾。

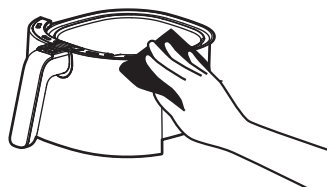

操作部分

接通電源時，蜂鳴器發出一聲蜂鳴聲，並進入待機模式。數碼屏微亮，顯示“——”，同時所有關鍵指示燈也微亮顯示。



使用前清洗

- 待機狀態下點擊任何一個鍵或調節旋鈕，進入功能選擇模式，此時所選的功能會閃爍，而其他功能的LED指示燈保持常亮狀態，這時可以通過調節旋鈕依次選擇其他功能。
- 點擊溫度（TEMP）鍵，數碼屏閃爍顯示溫度，可以通過調節旋鈕（左為-右為+）來調節。如果5秒內無任何操作，則自動確認。
- 點擊時間（TIME）鍵，數碼屏閃爍顯示時間，可以通過調節旋鈕（左為-右為+）來調節時間。如果5秒內無任何操作，則自動確認。
- 烹飪狀態下長按取消（CANCEL）鍵，或在1秒內連續按兩次取消鍵，蜂鳴器會發出一聲提示音，並返回到功能選擇。

使用注意事項

1. 切勿在空氣炸鍋中使用塑膠等不耐熱物品來盛放食物進行烹飪。
2. 切勿用玻璃或陶瓷容器盛放食物進行烹飪。
3. 根據自身口味來調整烹飪時間。烹調時間不要過長，以免食物燒焦，必要時取出炸桶，觀察食物情況。
4. 為保證更好的烘烤效果，建議在使用前將空氣炸鍋預熱3-5分鐘。
5. 空氣炸鍋處於工作狀態時及工作結束後的一段時間內，外表面和出風口的部件溫度可能很高，此時請勿隨意觸摸或移動空氣炸鍋，以免造成燙傷或其他危險。
6. 空氣炸鍋工作時，要確保炸桶推入整機到位，觸發微動開關，以免影響產品的運行安全和食物的烘烤效果。

使用方法

- 1 插上電源，進入待機模式。

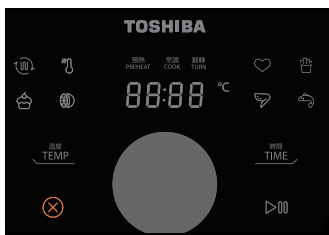
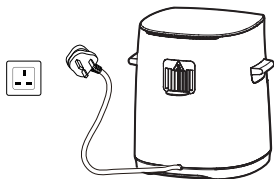

使用方法

2 按任意鍵或調整旋鈕進行功能選擇。

默認的“氣炸”功能會短時出現。向右旋轉旋鈕，選擇“氣炸-翻熱-烘焙-風乾-記憶-薯條-雞翼-魚-蝦”，向左旋轉旋鈕，選擇順序相反。

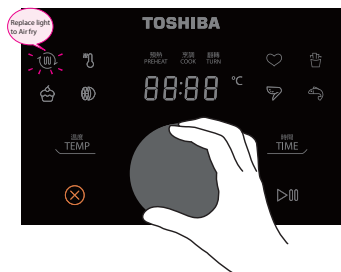

3 將食材放入炸桶/炸籃後，點擊開始 (START) 鍵或按下調節旋鈕進入烹飪模式。LED呼吸燈閃爍，“烹調(COOK)”狀態LED燈亮起，數碼屏交替顯示，顯示如下：

- 1、預熱模式：“PREHEAT”→“Add Food”→“180°C”和“00:17”
- 2、記憶模式：“Add Food”→“180°C”和“00:17”
- 3、智慧模式：“Add Food”→“[]”→“180°C”和“00:17”

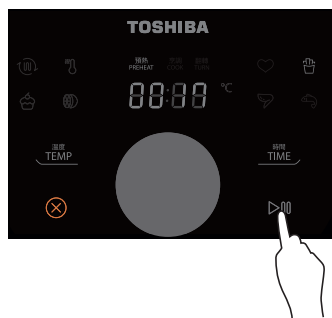
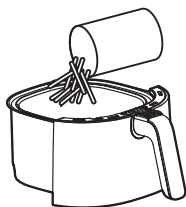
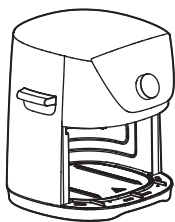

4 當食物需要翻面時 (只適用於某些功能)

- A. 在設定時間過半時，蜂鳴器會發出5次提醒。
- B. “翻轉(TURN)”狀態LED燈亮，數碼管顯示“turn Food”。
- C. 檢查炸桶是否在提醒後10秒內被移走。

- 1、如果是，數碼管顯示“OPEN”，把配料翻過來，然後把桶推回去；數碼管繼續顯示烹飪溫度和剩餘時間；
- 2、如果在10秒內沒有檢測到炸桶被取出，將繼續烹飪，“烹調(COOK)”狀態LED將亮起，數碼管將顯示烹飪溫度和剩餘時間。

使用方法

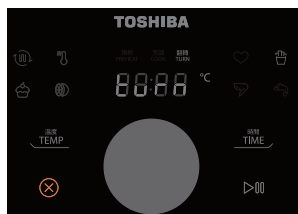

5 烹飪結束時

蜂鳴器發出5聲提示音，數碼屏顯示“End”，其餘的LED燈熄滅，風扇繼續運行一段時間，等到空氣炸鍋冷卻為止。

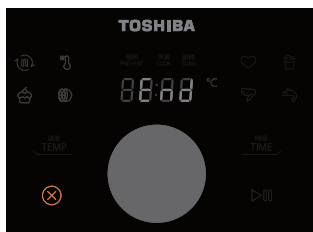

安全使用說明

1 將本產品平穩地放置在平坦的桌面上，電源線要足夠長，方便插入附近的插座，並在產品周圍留出30釐米以上的距離，不要靠近任何易燃物品。

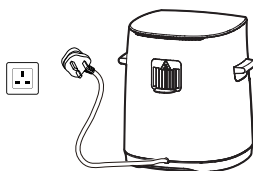
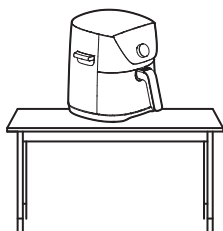

安全使用說明

2 根據烹飪食材和喜好，選擇炸籃組件後，將食材放入炸桶內，並將其推入本體。炸桶必須放置到位。

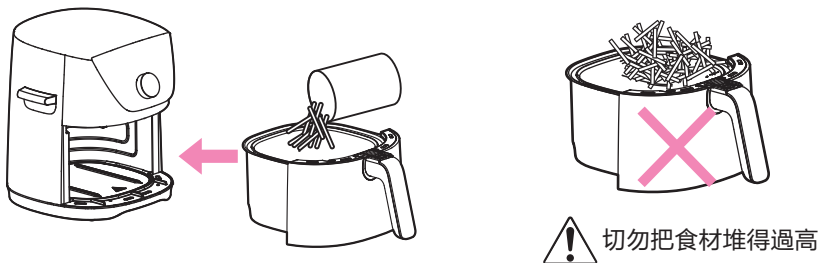

3 當數碼屏上顯示“End”時，表明烹飪結束，然後用一隻手按住產品的頂部，另一隻手握住炸桶的手柄將其拉出，然後將炸桶放在桌上的隔熱墊（或其他相同用途的平墊）上，借助輔助工具（如筷子等）取出烹飪好的食物。整個過程中，要注意不要碰觸到炸桶等發熱部件。

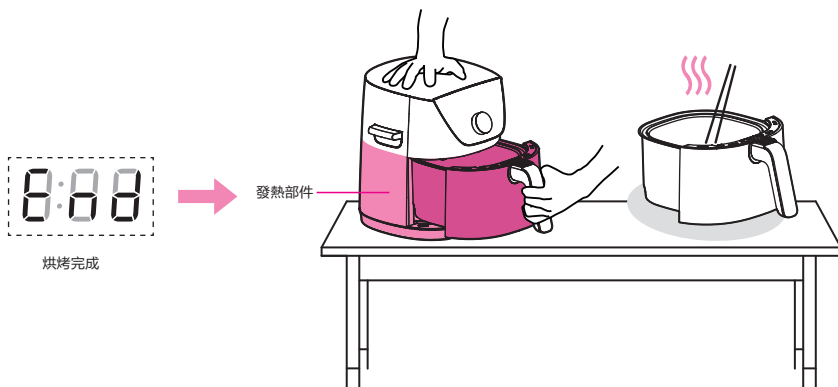

紙杯蛋糕製作方法



雞蛋



糖



檸檬汁



植物油



低筋麵粉



泡打粉

食材：雞蛋5個，糖90克，檸檬汁適量，植物油30毫升，低筋麵粉150克，泡打粉2克
製作方法：

1. 將雞蛋的蛋白和蛋黃分離，將蛋黃與植物油混合，放在一邊備用；將低筋麵粉和泡打粉混合。
2. 將蛋白、糖和檸檬汁混合，用打蛋器打到混合物不流淌，打出尖角為止；再加入蛋黃和植物油混合物，攪拌均勻，最後加入低筋麵粉和泡打粉混合物，攪拌到沒有乾粉為止；然後再倒入紙杯中，放入炸籃中，推入主機。
3. 選擇“烘焙”功能，按下調節旋鈕或點擊 ▷00 按鈕開始烹飪；溫度為170° C，烹飪時間默認為13分鐘。

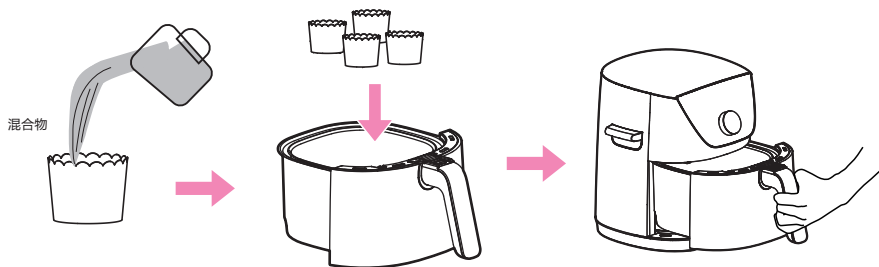

調整烹飪時間和溫度

| 圖示 | 烹飪類別 | 翻面 | 預熱 | 時間範圍(默認) | 溫度範圍(默認) | 備註 |
|--|------|----|----|----------------|------------------|--------------------------------------|
|  | 氣炸 | ✓ | ✓ | 1-60分鐘*(15分鐘) | 40-200°C*(200°C) | 根據個人喜好調整時間和溫度 |
|  | 翻熱 | ✓ | ✓ | 1-60分鐘*(10分鐘) | 40-200°C*(140°C) | 根據個人喜好調整時間和溫度 |
|  | 烘焙 | X | ✓ | 1-60分鐘*(10分鐘) | 40-200°C*(170°C) | 參閱“紙杯蛋糕製作方法” |
|  | 風乾 | X | ✓ | 1小時-12小時*(1小時) | 40-200°C*(100°C) | 將水果切片，約3毫米(如檸檬) |
|  | 記憶功能 | ✓ | X | 1-60分鐘*(10分鐘) | 40-200°C*(200°C) | 智慧模式 在此功能下記錄最後的時間和溫度 |
|  | 薯條 | ✓ | X | 1-60分鐘*(14分鐘) | 40-200°C*(180°C) | 智慧模式 建議使用約300克冷凍過的薯條 |
|  | 雞翼 | ✓ | X | 1-60分鐘*(14分鐘) | 80-200°C*(200°C) | 智慧模式 建議先將雞翅解凍，然後再醃制(約370克) |
|  | 魚 | ✓ | X | 1-60分鐘*(12分鐘) | 70-200°C*(180°C) | 智慧模式 建議使用新鮮食材；如選用冷凍食材，請先解凍；魚約600克 |

清潔和保養



注意

維修時，請先拔掉電源插頭，待本產品冷卻後再進行維修，否則會被燙傷。

請注意：

如果在清洗前使用本產品，可能會產生異味，所以請保持產品清潔。

切勿使用以下物品清洗本產品：

(因為可能會引起變形、腐蝕、變色、裂縫或劃痕等)

- 洗碗機和餐具烘乾機
- 除中性廚房洗滌劑外的其他洗滌劑
- 汽油、稀釋劑、酒精、去污劑和漂白劑
- 可產生劃痕的物品，如鋼絲絨、刀片等。

每次使用或弄髒炸桶和烤盤後，請使用海綿和中性廚房洗滌劑來清洗。

- 清潔時不要將空氣炸鍋本體身浸入水中。用擰乾的濕毛巾擦拭本體。
- 使用後清除烤盤和炸桶內的食物殘渣和其他異物，以免食物殘渣或油侵蝕，造成塗層損壞。
- 切勿用太濕的布擦洗空氣炸鍋，以免水進入內部電子部件，從而造成短路、火災、觸電等危險。
- 定期檢查產品，如有油污、灰塵等，應及時清洗。

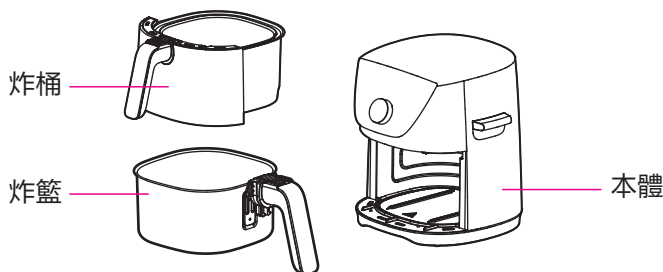

關於炸桶

切勿將炸桶或炸籃放在煤氣灶、電磁爐上或放入微波爐中。

切勿將炸桶或炸籃碰撞或掉落到硬物上。

切勿損壞炸桶或炸籃內側的氟聚合物塗層。

為防止炸桶或炸籃內側的塗層被刮傷或剝落，請注意以下幾點：

- 不要把餐具放入內鍋中，也不要將內鍋當作清洗桶使用。
- 不要使用刷子或洗碗機進行清洗。
- 不要使用去污劑、漂白劑等清洗（請用中性廚房洗滌劑清洗）。



※ 即使炸桶外側的塗層被劃傷，烹飪時也能正常工作。

使用炸桶時，在底下放一塊抹布，這樣內鍋外側底部不容易被劃傷。

故障診斷

| 故障 | 可能原因 | 解決方法 |
|---------------|-------------------|-------------------------|
| 產品不能正常工作 | 不通電 | 將電源線插入接地的插座中 |
| | 炸桶沒有安裝到位 | 拉出炸桶，再將其推回本體原位 |
| 風扇不轉或發出奇怪的噪音 | 電機損壞或其他部件發生短路 | 將產品送到指定維修站進行維修 |
| 不能順利地將炸桶推入產品中 | 炸桶邊緣變形 | 將產品送到指定維修站進行維修 |
| 冒白煙 | 正在氣炸油膩的食材 | 氣炸油膩的食材時，會冒很多煙，這屬於正常現象。 |
| | 炸鍋中仍有上次烤肉時留下的油脂殘渣 | 每次烘烤後一定要清潔炸鍋。 |
| E0故障代碼 | 過零異常保護 | 將產品送到指定維修站進行維修 |
| E1故障代碼 | 感測器斷路保護 | 將產品送到指定維修站進行維修 |
| E2故障代碼 | 感測器短路保護 | 將產品送到指定維修站進行維修 |

出現問題時的處理方法

| 問題點 | | 確認原因 |
|-----|--------------------|--|
| 工作時 | 薯條炸的不好 | <ul style="list-style-type: none"> ● 請檢查您是否使用冷凍薯條。 ● 如果您使用的是切好的薯條，我們建議調整烹飪時間和溫度。 |
| | 雞翼和其他肉類等其他食材沒有味道 | <ul style="list-style-type: none"> ● 請在烹飪前請先解凍並醃製。 |
| | 聞到焦味 | <ul style="list-style-type: none"> ● 拉出炸桶，檢查食物是否狀況良好。 ● 待產品冷卻後，檢查炸桶外側和發熱管是否有任何異物，如食物殘渣等。 |
| 顯示 | 無法進行按鍵操作 | <ul style="list-style-type: none"> ● 檢查電源插頭是否插好，炸桶是否安裝到位。 |
| | 蜂鳴器發出E1或E2故障代碼的提示音 | <ul style="list-style-type: none"> ● 請參閱下文的“螢幕顯示”一節內容 |
| 其他 | 聞到塑膠味 | <ul style="list-style-type: none"> ● 首次使用時，請將品在200° C下乾燒10分鐘。在乾燒過程中可能會冒出少量的白煙或氣味，這屬於正常現象，請勿驚慌。 |
| | 使用過程中發出聲音 | <ul style="list-style-type: none"> ● 使用過程中，風扇會發出“嗡嗡”的聲音。 |
| | 炸桶外側的塗層被劃或變髒 | <ul style="list-style-type: none"> ● 隨著使用時間的增加，炸桶外側的塗層會出現劃痕或變髒，但可以正常使用。 |
| | 烹飪時斷路器跳閘 | <ul style="list-style-type: none"> ● 與其他電器產品一同使用時，有時可能會超過斷路器的額定電流。請使用單獨的電源插座。 |

螢幕顯示

| | |
|--------------|---|
| ---- | 空氣炸鍋處於待機模式。 |
| Add Food | Menu-IQ預設：此信息在烹飪過程開始時出現。 烹飪模式：此信息的出現是爲了讓你知道空氣炸鍋已經達到了完美的烹飪溫度，可以向空氣炸鍋炸籃裏放入食材（如果還沒有放入的話）。 |
| 00:15 | 顯示幕上顯示烹飪時間和屏幕上出現的資訊。 |
| 150 °C | 顯示幕還顯示設定的烹飪溫度和屏幕上出現的資訊。 |
| Turn Food | 根據您的食譜建議，已經準備好將食材翻面或翻炒。 |
| End | 食物已經烹飪完畢，可以取出炸桶。 |
| [:] | 正在計算MENU-IQ預設的烹飪時間。 |
| PREHEAT | 空氣炸鍋正在進行預熱，確保提供最佳的烹飪性能。 |
| OPEN | 炸籃沒有正確安裝或拆除。 注意：如果出現此條資訊，此時不能進行任何操作。 |
| E1 | 溫度感測器斷路故障指示 |
| E2 | 溫度感測器短路故障指示 |

產品規格

| 型號 | 額定功率 | 電源 | 容量 | 重量 | 尺寸 |
|-----------------|------------|-------------------|-------|---------|-----------------------|
| AF-52CS1TRHK(H) | 1375-1600W | 220-240V~ 50-60Hz | 3.8 L | 4.98 kg | W310 x D371 x H320 mm |

*請隨時使用內炸籃烹飪。炸桶為5.2升。

■ 切勿在海拔2000米以上的地方使用本產品。

#DetailsMatter

USER MANUAL

AIR FRYER
AF-52CS1TRHK(H)

TOSHIBA



CATALOGUE

| | |
|--|----|
| TIP | 3 |
| SAFETY PRECAUTIONS | 4 |
| NAME OF PARTS | 9 |
| CLEANING PRIOR TO USE | 10 |
| OPERATION PART | 10 |
| CLEANING PRIOR TO USE | 11 |
| HOW TO USE | 11 |
| INSTRUCTIONS FOR SAFE USE | 13 |
| HOW TO MAKE CUPCAKES | 15 |
| ADJUST THE COOKING TIME AND TEMPERATURE | 16 |
| CLEANING & MAINTENANCE | 17 |
| TROUBLESHOOTING | 19 |
| WHAT TO DO WHEN A PROBLEM ARISES | 20 |
| SCREEN DISPLAY | 21 |
| SPECIFICATION | 21 |

TIP

Exclusive use for 220-240V AC

DO NOT use in electrical outlets other than 220-240V AC.

Thank you for your purchase of the Toshiba Toaster Oven (Air Fryer).

- **This appliance is for domestic use only. (Not for use as a commercial product).**
- **Please read the instruction manual carefully for the correct and safe use of this appliance.**
- **Always keep this instruction manual in a readily accessible place after reading it.**
- **Always keep this instruction manual in a safe place.**

Read the instruction manual carefully and keep it in a safe place.

Be sure to read the “Safety Precautions” (page 4 to 8) to use the product in a proper and safe manner.

SAFETY PRECAUTIONS

This section explains the content and importance of safety precautions to prevent bodily injury or property damage to users or others.

Please read the text with a full understanding of the following and be sure to observe these safety precautions.

- A description of the classification of hazards and damage (by degrees) caused by non-compliance with the use of items listed herein.



Warning

Contents that are likely to cause "death" and "serious injury"



Caution

Contents that are likely to result in "minor injuries" and "damage to premises and property etc."

- A description of the categories of contents to be followed.



Indicates the "Forbidden" contents



Indicates the contents of "Compliance with Instructions"



Indicates the "Caution" contents



Warning

For the prevention of injury, burns, electric shock, leakage, fire and damage to the house



This appliance is not intended for use by:

- Infants and young children
- Persons with physical, perceptual or intellectual incapacity
- Those who lack experience and knowledge

Use this appliance out of the reach of infants and children and do not allow them to play with it.



Any use of the product for purposes other than those stated in the manual is prohibited

- Failure to do so may cause fire, burns, injury or electric shock.



Stop using the appliance immediately in the event of an abnormality or malfunction

Stop using the appliance immediately in the event of an abnormality or fault
Unplug the appliance immediately and consult the retailer from whom you purchased it.
(Examples of abnormalities and faults)

- The power cord end and the power cord become hot.
- The power cord is damaged or intermittent power failure occurs when touching the power cord.
- The body is distorted or becomes hot.
- Smoke or burnt smell coming from the body.
- The body is broken, loose or makes a strange noise.
- No air coming out of the air vent while cooking.

SAFETY PRECAUTIONS



No dismantling

No dismantling, repair or alteration

Please have the product repaired or parts replaced at a professional maintenance outlet designated by manufacturer, to avoid improper maintenance or improper selection of parts that may cause hidden dangers.



Dismantling prohibited



Never clean the body, the power plug or the power cord with water; never expose the body to water or pour water on it; never pour water into the body



No flushing with water



No insertion of foreign objects into the air vent at the bottom

Such as pins, iron wire or other objects to avoid injury from electric shock.



No foreign objects



The exterior surface of the appliance will become hot during use, so do not touch the hot parts or put your hands or face near the air outlet, but use the body handle or the barrel handle; if you have to hold the barrel when it is hot, please protect yourself from burns.

Touch only the operating interface during operation and do not put your hands into the chamber to prevent burns.

Use power plugs, power cords and power sockets in a proper manner



DO NOT use the product if the power plug and power cord are broken or if the power socket is loose

Any dust or water stains on the power cord plug should be cleaned promptly to avoid fire, electric shock or short circuit; always use the special power cord; if the power cord is damaged, ask the manufacturer, its service department or a professional from a similar department to replace it in order to avoid danger.

No damage to the mains plug or power cable

It is forbidden to forcibly bend the power cord, place it near a high temperature (e.g. open fire, oven, etc.), tie it up, and carry heavy objects to avoid causing a fire or electric shock due to breakage of the power cord.



Do not touch with wet hands

DO NOT unplug the power supply with wet hands

Make sure that your hands are dry before unplugging the power supply.



Use the power socket of 220-240V AC and rated current of 10A or more separately

The socket may become abnormal and cause fire and other hazards if used together with other electrical appliances.

If an extension cable is required, please use a separate power outlet rated at 10A or more.

SAFETY PRECAUTIONS



Make sure the mains plug is fully inserted when in use. Always unplug the power cord when the product is not in use or when you are away from home to avoid malfunction or danger.

Be careful of tripping over or snagging the power cord in use

It may cause injury or a fire or electric shock due to the breakage of the power cord.

Make sure to use an earthed power socket

The power plug of this product should only be plugged into an earthed power socket. Failure to be fully earthed may result in electric shock due to fault or leakage.

Wipe off dust from power plugs regularly

Moisture will be generated if there is a build-up of dust and the insulation will be deteriorated and may cause a fire. Please wipe the dust off with a dry cloth.



This appliance is for indoor use only

Leave enough space around the product, keep a distance of 30cm or more from other objects, make sure there are no combustible objects around, such as tablecloths and curtains, and that the surface is not covered with any objects.

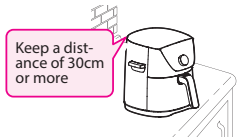

DO NOT move or shake the product during operation and keep the power cord or power plug away from the air outlet; please unplug the power cord after the body has cooled down before moving the product.



Before starting the product, check that the barrel is in place to avoid malfunctions.

DO NOT start until the barrel is put into the appliance



Do not cover the air vent of the appliance with cloths during operation, as this may cause accidents or damage to the product.

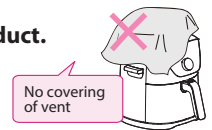

Use of non-special or deformed barrels is prohibited

To avoid burns or injuries due to excessively hot or malfunction.



Improper maintenance or improper shorting of some key components, such as fuses, may render the product protection ineffective and lead to either high temperature or fire.

SAFETY PRECAUTIONS



Never touch hot parts while in use or just after cooking

The body is very hot, especially the metal parts of the air outlet, the fryer barrel, the bottom heating plate and the protective mesh, so be sure not to touch it to avoid burns.

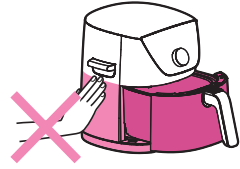

Improper maintenance or improper shorting of some key components, such as fuses, may render the product protection ineffective and lead to either high temperature or fire.



Items such as paper, plastic or flammable items must not be put into the appliance for baking.



DO NOT leave children to operate alone

Keep out of reach of babies and young children to avoid hazardous accidents such as electric shock and burns.



Use on an induction hob is prohibited

To avoid damaging the induction hob or causing faults to the product.



Stacking other objects or heavy items on top of the appliance is prohibited.



DO NOT keep away from the product for long periods of time during use

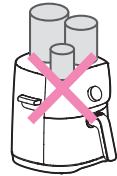

This product cannot be operated when connected with an external timer or under the system of independent remote control.

In case of a malfunction, be sure to stop using the product and contact our service department immediately

Persons with pacemakers or hearing-aid cochlear implants should consult an authorized medical practitioner and refer to the instructions provided with the medical device when using this product

Always use the product on a smooth, heat resistant surface to avoid damage or accidents.



Hold the mains plug while disconnecting it from the mains socket and pull it out

Failure to do so may result in a fire due to electric shock or short circuit.

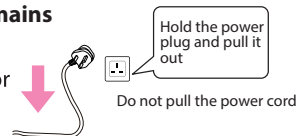

Always unplug the power cord when cleaning, or when the product is not in use or away from home to avoid malfunction or danger

SAFETY PRECAUTIONS

PLEASE NOTE

DO NOT place it in direct sunlight or splashes of oil

Otherwise it may cause distortion or discoloration.

When picking up the barrel by the handle or shaking the basket

do not press the WITHDRAW button on the handle to prevent the barrel from falling. To withdraw the frying basket, place it on a stable table and press the button on the handle to withdraw it.

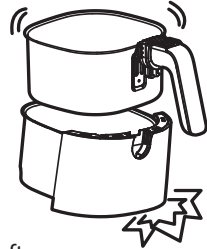

Clean the body and the surrounding area

It is recommended to clear any foreign objects such as food residues left on the frying barrel/basket after each use; to do so, switch off the power and ensure that the product has cooled down.

DO NOT knock or drop the barrel onto hard objects

As it may cause damage and deformation to the outside of the inner pot..



Never touch movable parts to prevent pinching.

DO NOT leave too much food to cook

As it may affect cooking results and expose food to other heating unit which could cause fire or bodily injury.

DO NOT cook with a large amount of cooking oil

The high temperature and hot air may cause risks such as grease smoke or fire.

DO NOT leave the barrel on a gas hob over a flame, or on an induction hob or in a microwave oven.

Otherwise deformation, discoloration or failure may occur.

DO NOT damage the fluoropolymer coating on the surface of the appliance

As this may cause the fluoropolymer coating to peel off.

DO NOT use the barrel as a storage unit.

■ The product should work at an altitude range of 0 – 2,000m.



Position with this symbol:

The surface is very hot during operation of the appliance and becomes hot during use.

- For first use, leave the appliance to dry burn at 200°C for 10 minutes. A small amount of white smoke or odor may appear during the dry burning process, which is normal and should not be alarmed.
- In case of discrepancies between the product images and the actual ones, the latter shall prevail.
- Please keep the manual properly for future reference.

NAME OF PARTS

■ Clean the fryer barrel and fryer basket before first use and remove food residues after each use.

■ Due to variations in the appearance of the product, the pictures below are for reference only and are subject to the physical product.

- A Air vents (top)
- B Air outlet
- C Transportation handle
- D Power cord
- E Control panel
- F Knob
- G Cooking cavity
- H Fryer basket
- I Protection Cover
- J Basket release button
- K Basket handle
- L Fryer barrel

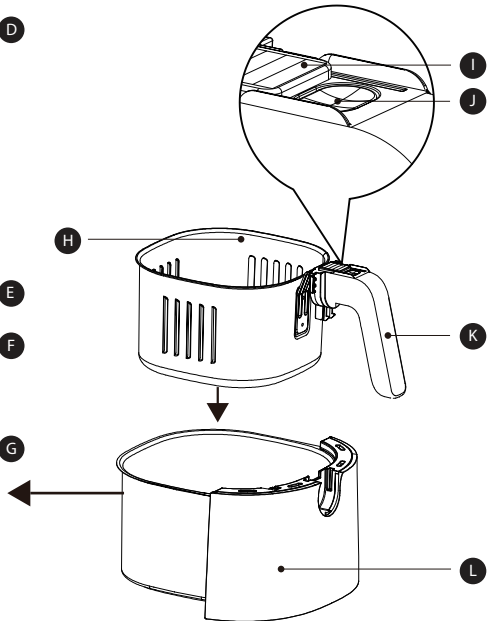
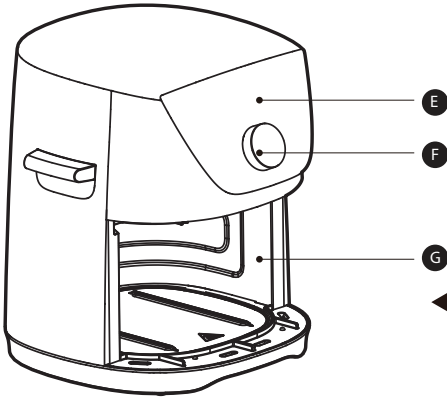
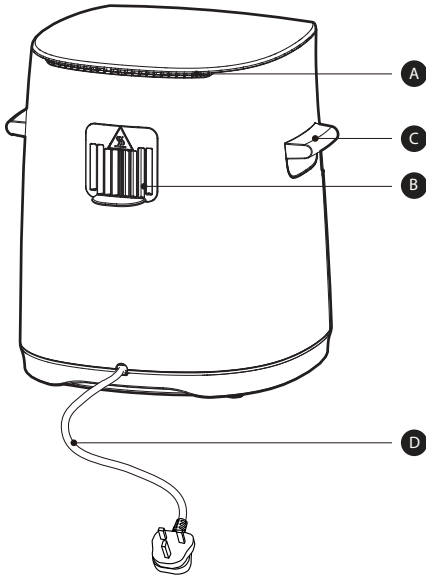

CLEANING PRIOR TO USE

Clean the basket and barrel

1 Rinse the basket and barrel with water prior to use.

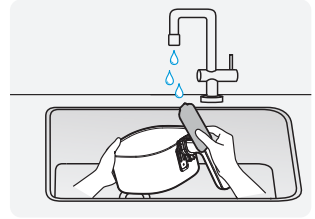

2 Dry with a clean soft cloth after washing.

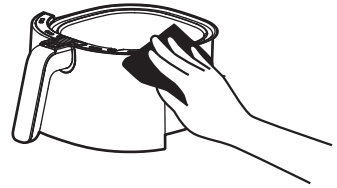

OPERATION PART

When the power is switched on, the buzzer beeps once and enters standby mode. The digital tube is illuminated by half-light showing "----" and all key indicators are also illuminated by half-light.



CLEANING PRIOR TO USE

- Click on any key or adjust the knob in standby mode to enter the menu selection state; the selected menu blinks while the other menu LEDs are always ON, at which point you can select other menus in turn by adjusting the knob.
- Click on the TEMP key, the digital tube flashes to show the temperature, which can be adjusted by adjusting the knob (- for left and + for right). It is automatically confirmed if there is no operation for 5 seconds.
- Click on the TIME key, the digital tube flashes to show the time, which can be adjusted by adjusting the knob (- for left and + for right). It is automatically confirmed if there is no operation for 5 seconds.
- Press and hold the CANCEL key in the cooking state, or press the CANCEL key twice in succession within 1 second, the buzzer will beep once and return to the menu selection.

Precautions for Use

- 1.Never use non-heat resistant items such as plastic to hold food in the air fryer for cooking.
- 2.Never serve food in glass or ceramic containers for cooking.
- 3.Adjust the cooking time to suit your taste. Do not leave for long periods of time while cooking to avoid scorching the food, and draw out the barrel if necessary to observe the food.
- 4.For better baking results, it is recommended to preheat the oven for 3-5 minutes before use.
- 5.The temperature of the hot part of the external surface and the air outlet may be very high when the air fryer is working and for a period of time after cooking is finished, so please do not touch or move the air fryer as this may cause burns or other hazards.
- 6.When the air fryer is working, make sure that the barrel is pushed into place and the micro switch is triggered to avoid compromising the operation safety of the appliance and the baking effect of the food.

HOW TO USE

- 1 Plug in the power supply and enter standby mode

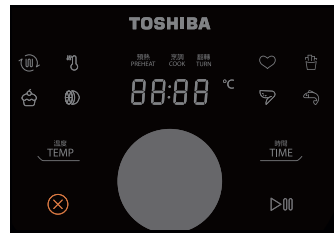
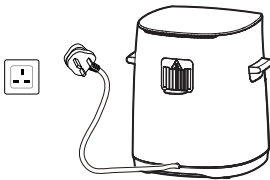

HOW TO USE

2 Press any key or adjust the knob for menu selection.

The default "Air Fryer" function flashes. Turn the knob right to select "Air Fry→Preheat Bake→Dehydrate→Memory→French Fries→Chicken Wings→Fish", and turn the knob left to reverse the selection.

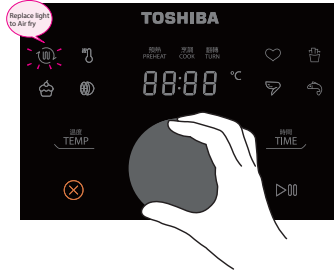

3 After putting the ingredients into the frying barrel, click on the START key or press the adjusting knob to enter the cooking mode.

The Breathing LED flashes, the "Cooking" status LED comes on and the digital tube alternately displays the following:

1. Preheat Menu: "P R E H E A T"→"A d d F o o d"→"180°C" and "00:17"
2. Memory Menu: "A d d F o o d"→"180°C" and "00:17"
3. Other MENU-IQ: "A d d F o o d"→"[- - -]"→"180°C" and "00:17"

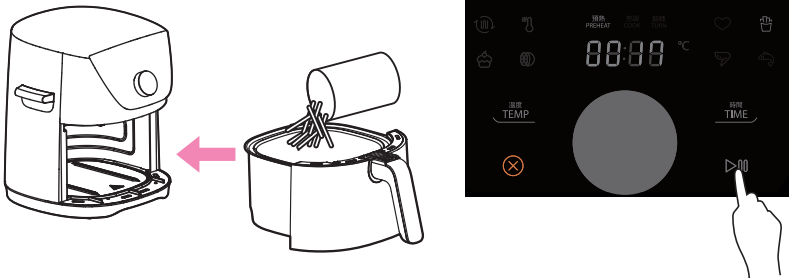

4 When it's time to turn over (Only applicable to some functions)

- A. the buzzer will beep 5 times to remind you half way through the set time.
- B. the "Turn Over" status LED will be ON and the digital tube will display "T u r n F o o d".
- C. Check if the barrel is removed within 10 seconds of the reminder.
 1. If it is, the digital tube displays "O P E N", then turn the ingredients over and push the barrel back; the digital tube resumes displaying the cooking temperature and remaining time;
 2. If the barrel is not detected to be withdrawn within 10 seconds, cooking will continue and the "Cooking" status LED will come on and the digital tube will display the cooking temperature and remaining time.

HOW TO USE

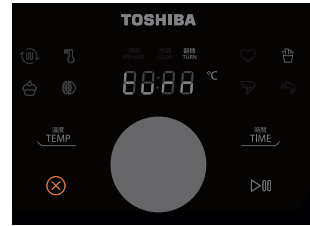
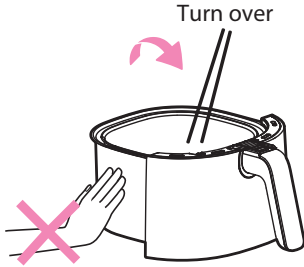

5 When cooking is finished

The buzzer beeps 5 times, the digital tube shows "End", the rest of the LEDs go out and the fan continues to cool the air fryer for some time.

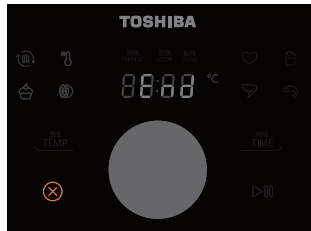

INSTRUCTIONS FOR SAFE USE

1 Place the appliance steadily on a flat table, with the power cord long enough to plug into a nearby socket, and keep a distance of 30 cm or more around the appliance and not near flammable objects.

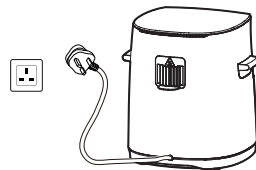
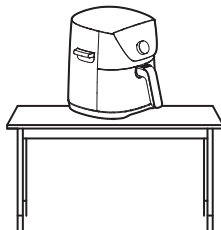

INSTRUCTIONS FOR SAFE USE

2 After selecting the frying basket assembly according to the cooking ingredients and preferences, put the ingredients into the barrel and push it into the main unit. The bucket must be fitted into place.

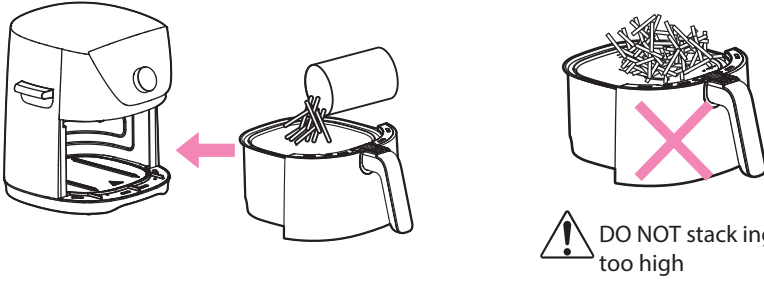

3 The cooking is finished when “End” is displayed on the digital tube, then press the top of the appliance with one hand and pull the barrel out by holding its handle with the other hand, then place the barrel on a heat insulating pad (or other flat pad of the same use) on the table and remove the cooked food with the help of auxiliary tools (e.g. chopsticks). Be careful not to touch hot parts such as the barrel throughout the process.

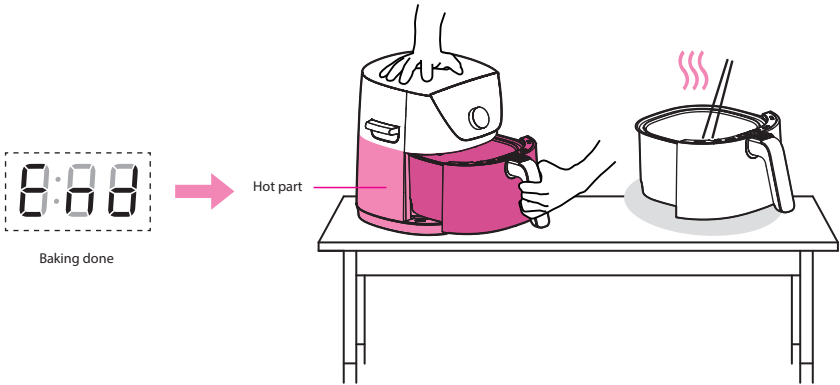

HOW TO MAKE CUPCAKES



Eggs



Sugar



Lemon juice



Vegetable oil



Low gluten powder



Baking powder







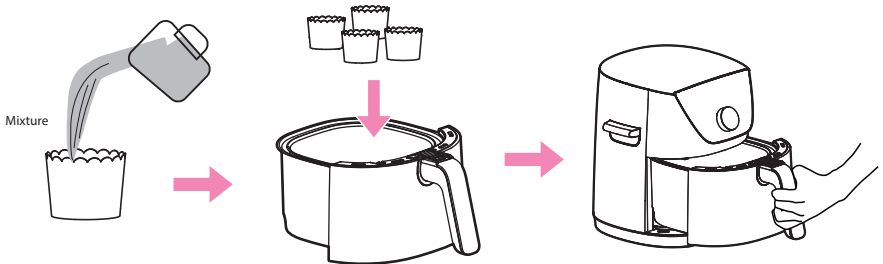

Ingredients: 5 eggs, 90g sugar, appropriate amount of lemon juice, 30ml vegetable oil, 150g low gluten flour, 2g baking powder

Method:

1. Separate the egg whites and yolks carefully, mix the egg yolks with the vegetable oil and leave aside; mix the low gluten flour and baking powder.
2. Mix the egg whites, sugar and lemon juice, beat with a whisk until the mixture is not runny and can be pulled out with sharp corners; add the egg yolks and vegetable oil mixture and mix well, finally add the mixture of low gluten flour and baking powder, mix until there is no dry powder; then pour it into paper cups, put it flat into a frying basket and push it into the main unit.
3. Select the "Cake" function and press the adjusting knob or click the button to start cooking; the $\triangleright 00$ temperature is 170°C and the cooking time is 13 minutes by default.



ADJUST THE COOKING TIME AND TEMPERATURE

| Icon | Category of Cooking | Turn | Preheat | Time Range (Default) | Temperature Range (Default) | Remarks |
|---|---------------------|------|---------|----------------------|-----------------------------|--|
|  | Air Fry | ✓ | ✓ | 1-60mins*(15mins) | 40-200°C*(200°C) | According to personal preference conditions time and temperature |
|  | Preheat | ✓ | ✓ | 1-60mins*(10mins) | 40-200°C*(140°C) | According to personal preference conditions time and temperature |
|  | Bake | X | ✓ | 1-60mins*(10mins) | 40-200°C*(170°C) | See how to make cupcakes |
|  | Dehydrate | X | ✓ | 1hr-12hrs*(1hr) | 40-200°C*(100°C) | Slice the fruit, about 3mm (e.g. lemon) |
|  | Memory | ✓ | X | 1-60mins*(10mins) | 40-200°C*(200°C) | Menu-IQ Record last time and temperature under this function. |
|  | French Fries | ✓ | X | 1-60mins*(14mins) | 40-200°C*(180°C) | Menu-IQ Frozen French fries approx. 300g is recommended |
|  | Chicken Wings | ✓ | X | 1-60mins*(14mins) | 80-200°C*(200°C) | Menu-IQ It is recommended to defrost and then marinate the chicken wings (approx. 370g) |
|  | Fish | ✓ | X | 1-60mins*(12mins) | 70-200°C*(180°C) | Menu-IQ Fresh ingredients are recommended; if you choose frozen ingredients, please thaw first; fish approx. 600g |

CLEANING & MAINTENANCE



Caution

For maintenance, unplug the appliance and leave it to cool down before carrying out maintenance, otherwise it will cause burns.

Please note

that odors may arise if the appliance is used before washing, so please keep it clean.

Never use the following items

(as they may cause distortion, corrosion, discoloration, cracks or scratches)

- Dishwashing dryers and tableware dryers
- Detergents other than neutral kitchen detergents
- Gasoline, thinner, alcohol, stain remover and bleach
- Items that can cause scratches such as steel wools, blades, etc.

Wash the barrel and baking tray after each use or soiling with a sponge and a neutral kitchen detergent

- DO NOT immerse the body in water when cleaning. Use a damp, wrung-out towel to wipe the body.
- Clear the food residues and other foreign objects from the barrel after use to avoid damage to the coating resulting from erosion of food residues or oil.
- DO NOT clean the air fryer with a cloth that is too wet to prevent water from entering the interior of the unit with the electronic parts, which may lead to short circuit, fire, electric shock and other hazards.
- Check the appliance regularly and clean it promptly if there is any oil, dirt, etc.

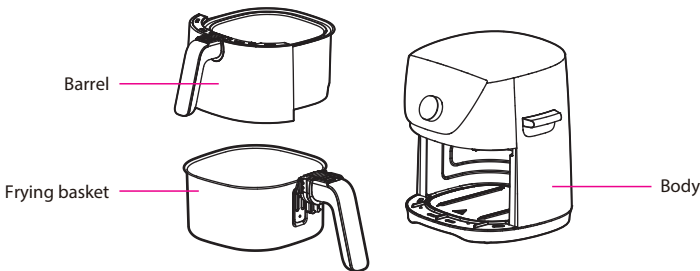

About the fryer barrel

DO NOT place the fryer barrel/basket on a gas hob over a flame, on an induction hob or in a microwave oven.

DO NOT bump or drop the fryer barrel/basket onto hard objects.

DO NOT damage the fluoropolymer coating on the inside of the fryer barrel/basket.

To prevent scratching or peeling of the coating on the inside of the fryer barrel/basket, please note the following:

- DO NOT place cutlery in the inner pot and use the pot as a wash bucket.
- DO NOT use brushes or dishwashing dryers for cleaning.
- DO NOT wash with stain removers, bleach, etc. (Wash with a neutral kitchen detergent)

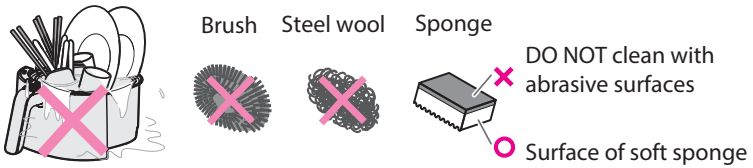

- ※ Even if the coating on the outside of the barrel is scratched, it will work properly when cooking.
When using the barrel, put a rag underneath to make the bottom of the outside of the inner pot less likely to be scratched.

TROUBLESHOOTING

| Fault | Possible Cause | Solution |
|--|---|---|
| Product does not work | Not powered on | Plug the power cable into an earthed socket |
| | Barrel not fitted in place | Pull out the barrel and push it back into the body in place |
| Fan does not turn or has a strange noise | Motor damaged or other components short-circuited | Send the product to the designated service outlet for repair |
| Failure to push the barrel into the product smoothly | Edge of barrel is deformed | Send the product to the designated service outlet for repair |
| White smoke comes out | Greasy ingredients are being roasted | It is normal that there will be a lot of smoke when roasting greasy ingredients |
| | There are still residues of grease left in the fryer from the last roasting | Be sure to clean the fryer after each bake |
| E0 alarm | Zero-crossing exception protection | Send the product to the designated service department for repair |
| E1 alarm | Sensor open-circuit protection | Send the product to the designated service department for repair |
| E2 alarm | Sensor short-circuit protection | Send the product to the designated service department for repair |

WHAT TO DO WHEN A PROBLEM ARISES

| At times like | | Identification of causes |
|---------------|---|--|
| When cooking | French fries cannot be cooked properly | <ul style="list-style-type: none"> ● Please check if you are using frozen French fries ● If you are using cut potato fries, we recommend adjusting the cooking time and temperature. |
| | No taste for other ingredients such as chicken wings and other meats | <ul style="list-style-type: none"> ● Please defrost and marinate before cooking. |
| | Smell of burning | <ul style="list-style-type: none"> ● Pull out the barrel to check that the food is in good condition. ● After the appliance has cooled down, check the outside of the barrel and the heat pipe for any foreign objects such as food residue. |
| Display | When key operation is not possible | <ul style="list-style-type: none"> ● Check if the power plug is plugged in and the barrel is fitted in place. |
| | Buzzer beeps with an E1 or E2 fault code | <ul style="list-style-type: none"> ● Refer to the “Screen Display” section below |
| Others | Smells of plastic etc. | <ul style="list-style-type: none"> ● For first use, leave the appliance to dry burn at 200°C for 10 minutes. A small amount of white smoke or odor may appear during the dry burning process, which is normal and should not be alarmed. |
| | Sounds made during use | <ul style="list-style-type: none"> ● The fan makes a “buzzing” sound during use. |
| | The coating on the outside of the barrel is scratched or contaminated | <ul style="list-style-type: none"> ● With increased use, the coating on the outside of the barrel will be scratched or stained, but it can function normally. |
| | Circuit breaker tripped during cooking | <ul style="list-style-type: none"> ● The current rating of the circuit breaker may sometimes be exceeded when used together with other electrical products. Please use a separate power socket. |

SCREEN DISPLAY

| | |
|--------------|--|
| ---- | The air fryer is in standby mode. |
| Add Food | For Menu-IQ preset: This message appears at the beginning of the cooking process. For Cooking Modes: This message appears to let you know that the air fryer has reached the perfect cooking temperature and food can be added to the air fryer basket (if it hasn't been already). |
| 00:15 | The display shows the cooking time and on-screen messages. |
| 150 °C | The display also shows the set cooking temperature and on-screen messages. |
| Turn Food | Food is ready to be turned or tossed, as recommended by your recipe. |
| End | Food is ready and the basket can be removed. |
| [:] | Cook time is being calculated for the MENU-IQ preset. |
| PREHEAT | Air fryer is preheating to give the best cooking mode performance. |
| OPEN | Basket is not installed properly or removed. Note: no operation can be made if this message appears. |
| E1 | Temperature sensor open-circuit fault indication |
| E2 | Temperature sensor short-circuit fault indication |

SPECIFICATION

| Model | Power rating | Power supply | Capacity | Weight | Dimensions |
|-----------------|--------------|-------------------|----------|---------|-----------------------|
| AF-52CS1TRHK(H) | 1375-1600W | 220-240V~ 50-60Hz | 3.8 L | 4.98 kg | W310 x D371 x H320 mm |

*Please feel free to use the inner fryer basket for cooking. The fryer is 5.2 liters.

■ Never use this product at altitudes above 2,000m.

#DetailsMatter