

TOSHIBA



Toshiba Electric Hot Pot (For household use)

Instruction Manual



Model

| | | | |
|-----------|-----------|-------------|-------------|
| PLK-25DL | PLK-30DL | PLK-25DLI | PLK-30DLI |
| PLK-25VE | PLK-30VE | PLK-25VEI | PLK-30VEI |
| PLK-25EL | PLK-30EL | PLK-25ELI | PLK-30ELI |
| PLK-25FL | PLK-30FL | PLK-25FLI | PLK-30FLI |
| PLK-25VF | PLK-30VF | PLK-25VFI | PLK-30VFI |
| PLK-25FLE | PLK-30FLE | PLK-25FLEIS | PLK-30FLEIS |



- Thank you for buying Toshiba electric hot pot today.
- The electric hot pot is used for boiling water only.
To apply this product safely and properly, please read the manual thoroughly and well understand before use.
- After reading, please keep the manual handy.

SAFETY PRECAUTION Follow the instruction strictly.

● This page is mainly referred to the safety precaution to prevent the property damage and the danger to the users and others. After understanding these details clearly (the indication and the symbols), please read and follow the specified items.

| SIGNAL EXPLANATION | |
|---|--|
|  | WARNING Indicating “when the product is used wrongly, it may cause severe injuries ^{*1} and death.” |
|  | CAUTION Indicating “when the product is used wrongly, the user may get injured ^{*2} or the product may cause the property damage ^{*3} .” |

*1 : Severe injuries mean to get blind, wound, burnt (high and low temperature), an electric shock, broken bones, and poison, etc. Consequently, there may be some symptoms and you may go to the hospital and it takes a long time to cure.
 *2 : Getting injured means you get wound, burnt, an electric shock. However, you do not have to go to the hospital for long cure.
 *3 : Property damages mean the damage to the accommodations, properties, farmland, and pets, etc.

| SYMBOL EXPLANATION | |
|---|---|
|  | ⊘ indicates prohibition (must not do). The details of the prohibition will be instructed by sentences or illustration nearby or in the symbol. |
|  | ● indicates mandatory (must do). The details of the mandatory will be instructed by sentences and illustration near or in the symbol. |
|  | △ indicates caution. The details of the caution will be instructed by sentences or illustration nearby or in the symbol. |

WARNING

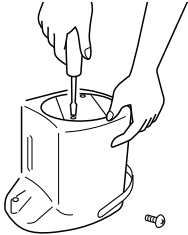

Do not disassemble.

Do not disassemble or repair.
 It may cause fire, an electric shock, and injury.
 For repair, please contact the shop you purchased or Toshiba repair information center.





Do not touch.

Do not directly touch the steam vent with your hand.
 It may cause burn.
 Please be more carefully not to allow small children to touch the vent.





Wet hand is prohibited.

Do not connect or disconnect the power cord when your hand is wet.
 It may cause an electric shock or injury.

Close it firmly.

Close the lid firmly.
 If the pot falls down, the water will flow out and you may get burnt.

PROHIBITED

Do not boil anything except water.
 When tea, milk, or alcohol, etc. gets hot, it may splash over and you may get burnt.

PROHIBITED

Do not put any ice in the pot to keep the water cool.
 There will be some moisture on the outside of the pot. This can cause an electric shock and some accidents.

PROHIBITED

Do not cover the steam vent with clothes or anything.
 The hot water may splash over and you may get burnt.

PROHIBITED

Close the lid loosely.
 The hot water may splash over and you may get burnt.

(WARNING continued)



PROHIBITED

Do not fill the water more than the maximum of the water level gauge.

The hot water may splash over and you may get burnt.



PROHIBITED

Do not allow the children to apply this appliance and keep it out of reach from the children.

It may cause burns, an electric shock, and injury.



Do not do anything improperly with the pot.

Do not scratch, bend, pull, twist, or connect the power cord when you put the object on it. Do not place it near the heating source. Do not put the heavy objects, pinch, or modify the cord.

The cord may be damaged, and then cause the fire and an electric shock.



Do not soak the pot.

Do not wet or immerse the pot into the water. Do not wash the pot thoroughly. Do not immerse the bottom of the pot into the water and do not turn over the pot while its bottom is wet.

Do not wet the power cord.

It may cause a short circuit, an electric shock, and injury.



PROHIBITED

Do not tilt the pot.

Although the button is locked, the water can flow out from the water dispenser or the steam vent when the pot is tipped, and it will cause burns.



PROHIBITED

When moving the pot, do not hold the lid.

The water will flow out from the dispenser or the steam vent. Then the pot may slip and fall down, and cause some burns and injury.



PROHIBITED

Do not terribly shake (especially vertically shake) or strike the pot.

With the dispensing lock, if the pot is terribly shook or stroked, the water can flow out from the dispenser or the steam vent, and may cause burns.



PROHIBITED

Do not throw away the water with the lid closed.

If the lid is accidentally detached, the water will spill over, then cause some burns.



PROHIBITED

Do not let the pot fall down.

With the dispensing lock, if the pot falls down, the water can flow out from the dispenser or the steam vent, and may cause burns.



Remove the dust.

If the power plug or its polar is dusty, wipe it away with the dry cloth.

It may cause fire.

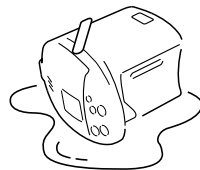

Fit the plug into the socket fully.

Fully fit the plug into the socket.

It may cause an electric shock, a short circuit, and fire.



PROHIBITED

Do not use if the cord or the power plug is broken, or if the power plug is loose.

It may cause an electric shock, a short circuit, and ignition.



Insert the power plug into the hole completely.

Insert the power plug (main body side) into the plug insertion hole on the rear side of the main body.



PROHIBITED

If the power supply cord is damaged, it must be replaced by the manufacturer, its service agent or similarly qualified persons in order to avoid a hazard.

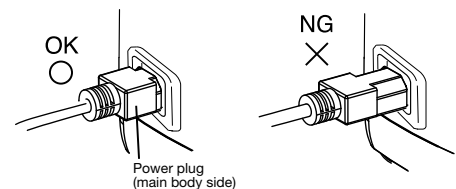

⚠ CAUTION



Unplug.

Pull the plug from the AC outlet when not in use.

It may cause injury, burns, an electric shock or electric leakage due to the deterioration of the insulation.



Hold the plug and pull.

When disconnecting, hold the plug and pull it out without touching the cord.

It may cause an electric shock or a short circuit, and then lead to fire.



PROHIBITED

Do not place the unit on the hot, delicate, or unstable surface.

It may cause fire.



PROHIBITED

Do not pour the water or open the lid while boiling.

The steam or the hot water may splash over and cause some burns.



Do not touch.

Do not directly touch the steam when opening the lid.

It may cause burn.



Do it after cool down the pot.

Maintain after leaving it cool.

In case of touching the hottest part, it may cause some burns.



PROHIBITED

Do not use the pot near the wall or the furniture.

The steam or the heat will deteriorate, decolor, or distort the wall and the furniture.



PROHIBITED

When moving the pot, do not hold the lid release lever.

The lid will automatically open and cause injury or burns.



Do not touch.

While using or right after using the pot, do not touch its hot part.

It may cause burn.



PROHIBITED

Do not use any other power cord except the attached cord, nor use the power cord with other appliances.

It may cause an accident and fire.



PROHIBITED

While pouring, do not rotate the pot.

The water may splash over and cause some burns.



PROHIBITED

This appliances is not intended for use by person (including children) with reduced physical, sensory or mental capabilities, or lack of experience and knowledge, unless they have been given supervision or instruction concerning use of the appliance by person responsible for their safety.

children should be supervised to ensure that they do not play with the appliance.



PROHIBITED

This appliance is intended to be used in household and similar application such as

- Staff kitchen areas in shops, offices and other working environments.
- Farm houses.
- By clients in hotels, motels and other residential type environments.
- Bed and breakfast type environments.



PROHIBITED





Do not expose the power plug or other electrical components to hot steam.



PROHIBITED

Be especially careful when placing and using the appliance on the kitchen counter, to avoid steam attached to the plug and cause electric shock or fire.

IMPORTANT DOCUMENT ON SAFETY PRECAUTION

| | |
|---|--|
|  |  Indicates the forbidden operation. |
|  |  Indicates the information which should be followed strictly. |

Safety Warning

| | |
|---|--|
|  Forbidden | <p>Do not disassemble, repair, fix, or modify the product (unless indicated in the operation manual).</p> <p>Do not pull or insert the electric plug and the magnetic plug with wet hands.</p> <p>Do not touch the product, cable, or electric plug with wet hands.</p> <p>Do not operate the product if the cable or electric plug is damage, or the electric plug is inserted improperly.</p> <p>Do not modify or repair the cable and electric plug or use other cables which are not included with the product (except the ground wire).</p> <p>Do not bend, break, twist, or pull the cable while the product is operating.</p> <p>Do not place the product or other objects on the cable or pinch the electric plug or the cable.</p> <p>Do not place the electric plug or cable in the place with high temperature, flooded water, and high humidity or touch it with sharp-edge object.</p> <p>Do not connect the product to the power source which is not specified in the operation manual.</p> <p>Do not expose the product to water.</p> <p>Do not use the adaptor plug in order to fit in the power outlet.</p> <p>Do not use the power outlet together with other electric appliances.</p> |
|---|--|

Safety Caution

| | |
|---|--|
|  | <p>Insert the electric plug into the power outlet as far as the base of the electric plug. To unplug, hold the body of the electric plug and pull it off.</p> <p>Wipe dust or moisture at the electric plug's pins thoroughly before inserting it into the power outlet.</p> <p>Pull the electric plug out of the power outlet when the product is not in use.</p> <p>Pull the electric plug out of the power outlet before maintaining or cleaning the product.</p> |
|---|--|

Caution for Safety Installation

| | |
|---|---|
|  | <p>Do not bring any flammable object, hazardous object, chemicals, or flammable gas near or in the product.</p> <p>Do not install the product near the naked flame, wet area, or hot and high humidity area.</p> <p>Do not install the product in the high electromagnetic area.</p> <p>Do not install the product in the area within a child's reach.</p> <p>Do not install the product on the slant or insecure floor.</p> <p>Connect the ground wire at the specified position on the product.</p> |
|---|---|

Caution for Safety Operation

| | |
|---|---|
|  | <p>Read the operation manual carefully and thoroughly before using the product.</p> <p>Always inspect that the product is in a good operating condition before using by following the recommendation in the instruction manual.</p> <p>Remove all packing materials.</p> <p>Do not allow children to use the product alone.</p> <p>Do not place any object on the product or cover the product while in use (unless indicated in the operation manual).</p> <p>Do not touch any hot or cold parts of the product.</p> |
|---|---|

HOW TO INSTALL EARTH LEAD WIRE

(Model PLK-25DL, PLK-30DL, PLK-25VE, PLK-30VE, PLK-25EL, PLK-30EL, PLK-25FL, PLK-30FL, PLK-25VF, PLK-30VF, PLK-25FLE, PLK-30FLE)

1. Remove Screw. Spring washer and Flat washer on Earth connecting plate.



2. Set Earth lead wire on Earth connecting plate then put Flat washer and Spring washer respectively on Earth lead wire and fixing screw tightly.

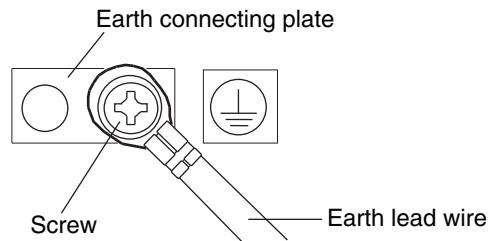

PART NAMES AND FUNCTIONS

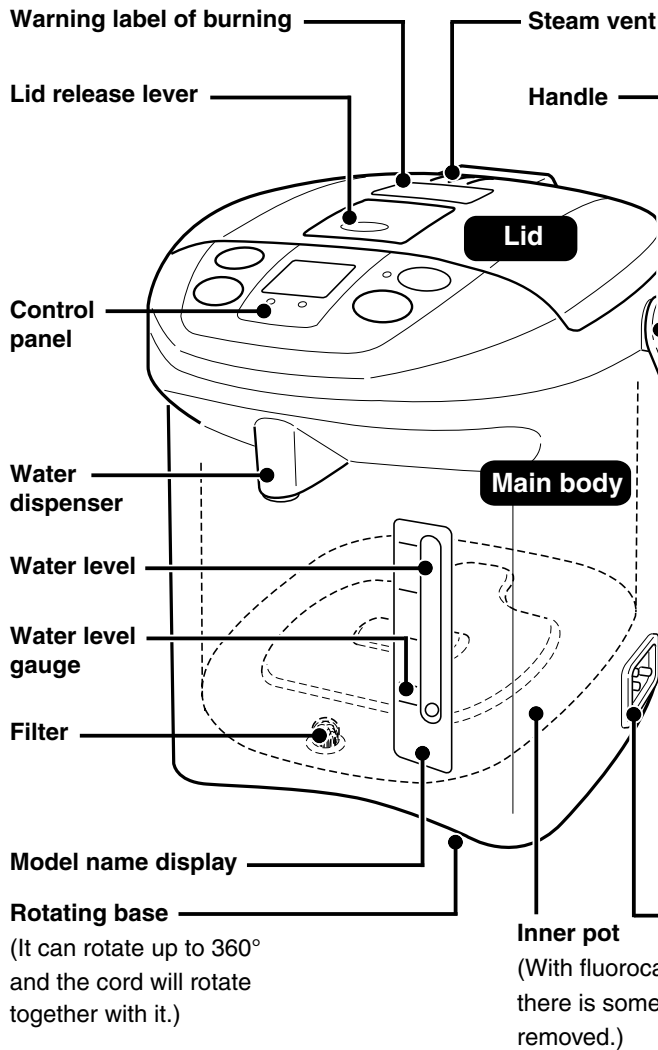

Power cord 3 pins

For model : PLK-25DLI, PLK-25VEI, PLK-25ELI, PLK-25FLI, PLK-25FLEIS, PLK-30DLI, PLK-30VEI, PLK-30ELI, PLK-30FLI, PLK-30FLEIS

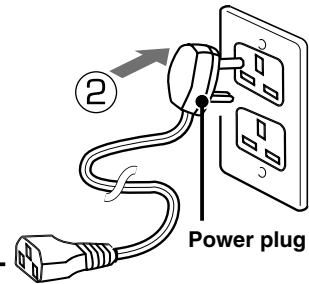

Power cord 2 pins

For model : PLK-25DL, PLK-25VE, PLK-25EL, PLK-25FL, PLK-25FLE, PLK-30DL, PLK-30VE, PLK-30EL, PLK-30FL, PLK-30FLE

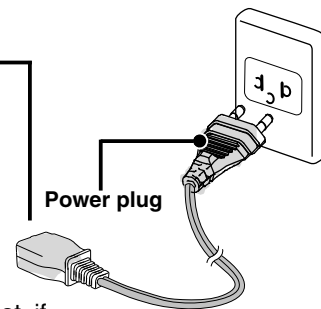

Regarding the power cord.

For the figure, the power cord 3 pins plug is for grounded socket version.

How to open, detach, and install the pot

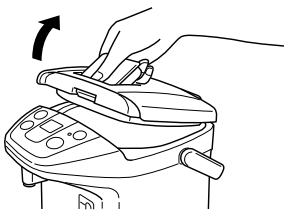

How to open the lid

Press the “PRESS” on the lid release lever. Then lift it up.

- When closing the lid, please push it down until you hear the “click” sound.

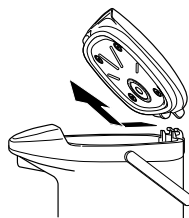

How to detach the lid

Open the lid up to 60°. Then pull it into the direction of the water dispenser and lift it up.

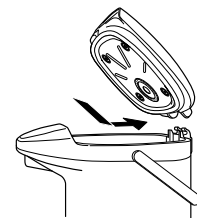

How to install the lid

Please follow the process of “How to detach the lid” in reverse.

PART NAMES AND FUNCTIONS (continued)

Control Panel

Braille is shown near the button.

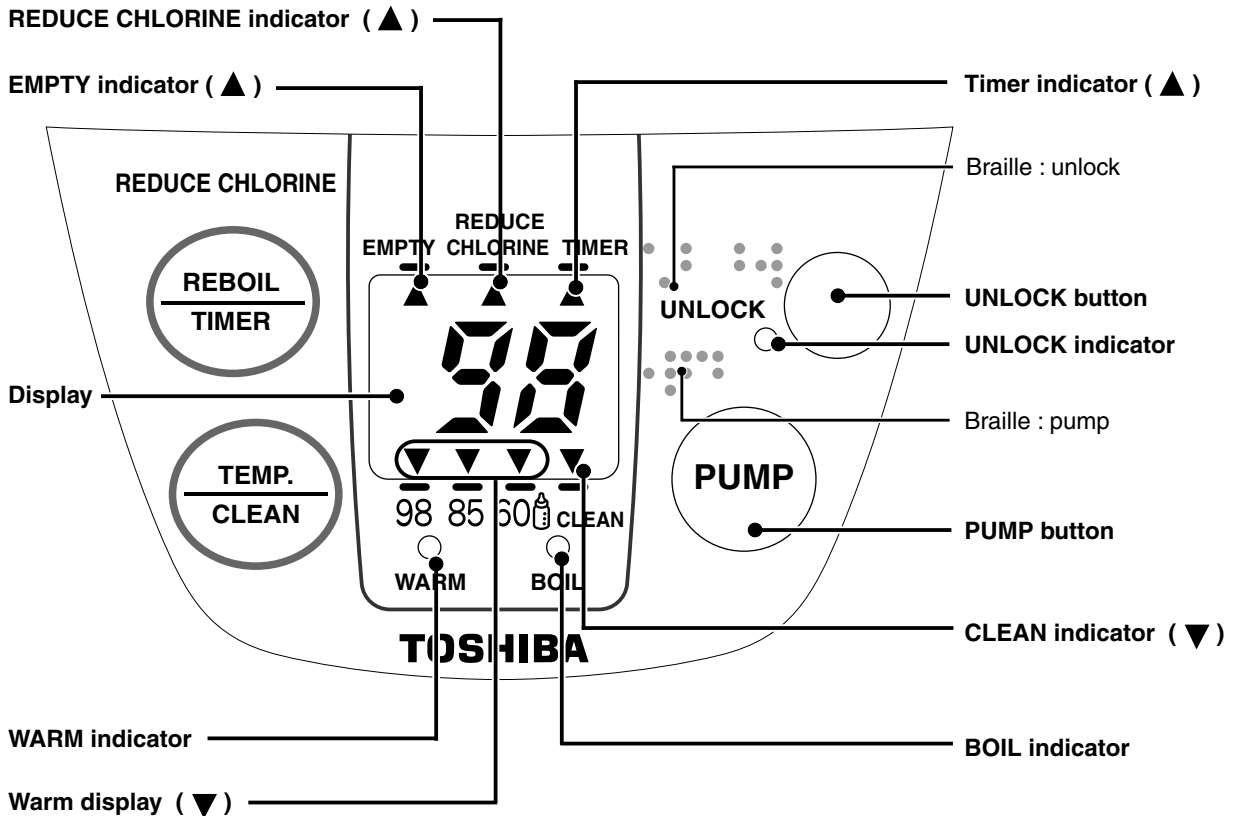
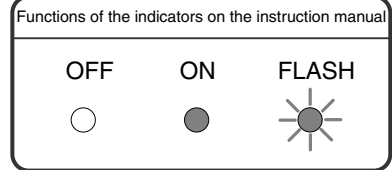

Warm display (▼)
The selected warming temperature of "98", "85" and "60" will light up.

NOTE

- Do not wet the bottom of the pot.
If the pot is turned over while it is wet, the water will flow into the inner part of the pot and can cause the accident.
- Do not use the appliance near the radio, etc.
Please keep it away from the place affected by a radio, television, etc.
It may cause a loud noise.
- Do not use it near the fire.
The pot may be damaged and deformed.
- Do not directly supply the water from the tap into the pot.
- Do not pour out all the water remaining using the button on the control panel.
- Please pour out the water remaining directly from the pot.
If the water is left inside the pot, it may discolor the water or the water may be smelly.
- When pouring out the water, do not touch the dispenser.

FOR THE FIRST TIME USE (In case of not using the pot for a long time)

Once boil the water at the temperature of “98”. After that, press the PUMP button to pour some water. Then, pour out all the water remaining from the pot. And the pot can be used generally.

1 Put the water into the inner pot and close the lid.

- For example, pour the water from the kettle.

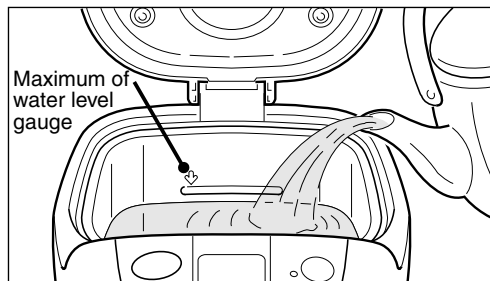

2 Connect the power plug. Then boil the water at the temperature of “98”.

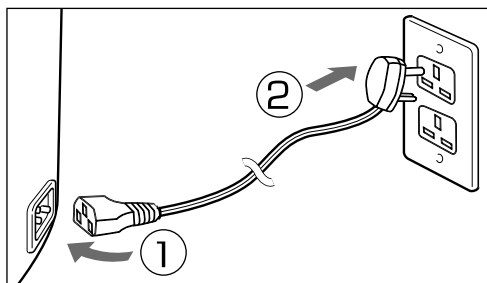

3 Press the PUMP button and pour out about half of the water.

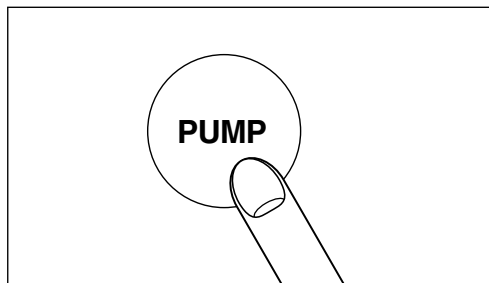

4 Pour out all the water remaining.

- After unplugging, detach the lid and pour out the water as shown in the picture.

Please do not pour out the water using the button on the control panel.

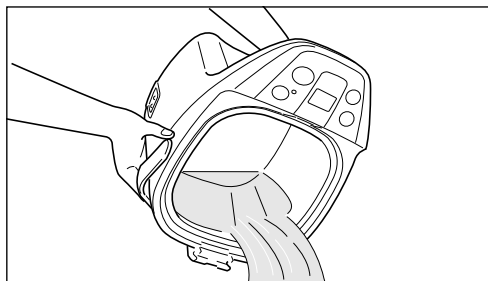

BOILING/POURING

BOILING

Put the water in the pot and close the lid. Connect the plug. Then press the button to select the temperature.



▶ The BOIL indicator will light up. And after the selected TEMP indicator (▼) flashes about 2 seconds, the display will light up instead.

- The display will show the raising water temperature by 5°C at a time. If the temperature is lower than 15°C, Lo will appear. The displayed temperature is as a measure. It may change depending on the amount of water or the room temperature.

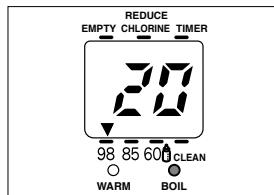

■ When selecting the temperature of “98”

▶ When the water boils, the BOIL indicator will light off and the WARM indicator will light up noticeably.

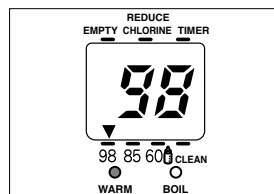
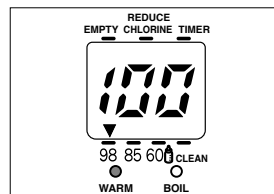

■ When selecting the temperature of “85” and “60”

▶ When the water boils, the BOIL indicator will light off and the selected WARM indicator will flash

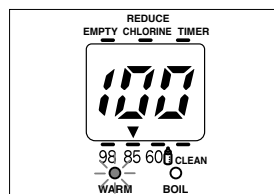

▶ When reaching the selected temperature, the WARM indicator will light up noticeably.

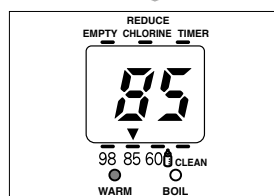

| Indication | For |
|------------|--|
| | At the temperature of “98” Coffee, Chinese tea, instant cup noodle, etc. |
| | At the temperature of “85” Japanese tea, etc. |
| | At the temperature of “60” Mixing milk, etc. (After melting the milk powder, let it cool down to the proper temperature.) |
| | (Cleaning) |

● The time range of water boiling

- 2.5L: About 25 minutes
- 3.0L: About 30 minutes

● The range of time after boiling to the temperature of “85”

- 2.5L: About 50 minutes
- 3.0L: About 60 minutes

● The range of time after boiling to the temperature of “60”

- 2.5L: About 3 hours
- 3.0L: About 3 hours and 30 minutes

NOTICE

- Although the power cord is unplugged, the previous set temperature will not change until the temperature is adjusted next time.
- The boiling point will change depend on high from sea level and the pressure. Then the selected keep warm temperature will concern also. (In case the selected keep warm temperature is “98”.)
- If the room temperature is higher after the water boils, it will take more time to reach the selected temperature.
- The warming temperature can be altered although the water is being warmed. The boiling point will depend on the water temperature at that time.
- In case of using the ionized alkaline liquid, the resin will return yellow.

NOTE

- Do not fill the water while the electric pot is decreasing temperature to keep warm at selected (98, 85, 60). Due to the quantity of filled in the inner pot may be not enough to reboil.

POURING

WARNING

**Do not turn over or tilt the pot.
Do not terribly shake (especially shake up and down) or strike the pot.
Do not hold the lid while moving the pot.**

The water will flow out from the water dispenser or the steam vent. Then the pot may slip and fall down, and cause some burns and injury.



PROHIBITED

- 1 Press the UNLOCK button, then the button will be unlocked.**

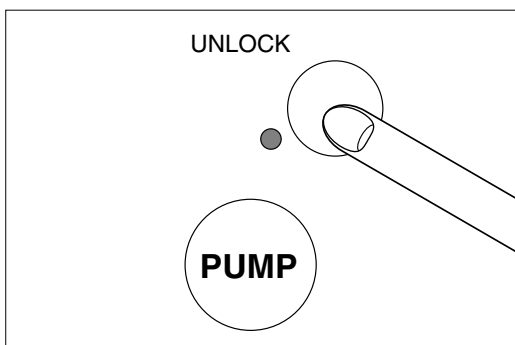

- ▶ The UNLOCK indicator will light up.
- About 2 seconds after the pot is unlocked, the water can be poured out. And 2 minutes later, the pot will be automatically locked.

- 2 Place the cup under the water dispenser and press the PUMP button. Then, the water will pour out.**

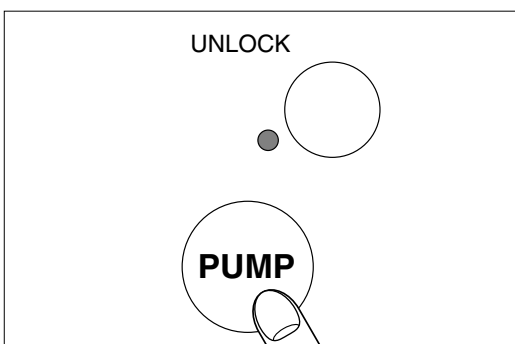

- **The UNLOCK indicator will light up.**
When wanting to lock right after pouring water Press the UNLOCK button and the UNLOCK indicator will light off

When there is very little water

Fill the water before the water reaches the water level gauge

When not in use

Unplug the power cord and detach the lid. After that, pour out all the water.

■ Regarding the prevention to warm the empty pot

To prevent the accident from overheating, if it is found that the empty pot is warmed (for example, there is the distribution of power supply when the pot is empty.), the electric current distributed to the heater will be cut off and it is noticeable from the indicator flashing.

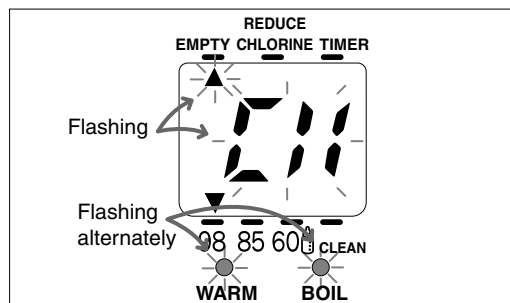

→ Please fill the water and press the  button.

- If the empty pot is warmed many times, the coated fluorocarbon-resin may discolor or peel away.

REBOILING/REDUCING CHLORINE/SETTING TIMER

The water will be reboiled while warming.

Press the  button once.

Example: In case warming at the temperature of “98”

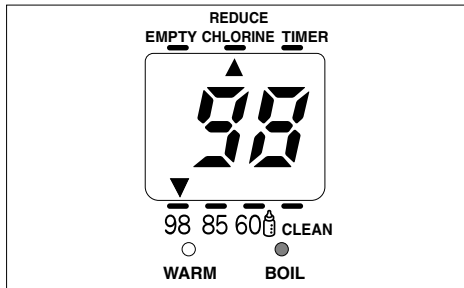

► The BOIL indicator will light up.

● The time range of water reboiling

- At the temperature of “98”: About 2 - 8 min
- At the temperature of “85”: About 10 - 11 min
- At the temperature of “60”: About 16 - 18 min
(The amount of water : maximum water/the room temperature : 20°C)

Reducing chlorine

Press the  button once while boiling and press it twice while warming. Then, the REDUCE CHLORINE indicator (▲) will light up.

Example: In case of warming at the temperature of “98”

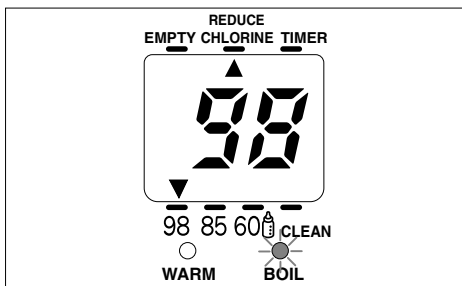

- The BOIL indicator will flash and the REDUCE CHLORINE indicator (▲) will light up.
- While the water has been boiling for 3 minutes, the amount of chlorine will be reduced.

● When the water is reboiled

- Please press the button twice.

12

SETTING TIMER

About 6 hours after the hot water is kept at the low temperature, the pot will automatically turn to the selected temperature.

If it is applied before lunchtime or before you go out, warming the water at “98” and “85” will economize on electricity, but setting timer at the temperature of “60” cannot do.

When keeping the temperature of “98”

or “85”, press the  button and

the TIMER indicator (▲) will light up.

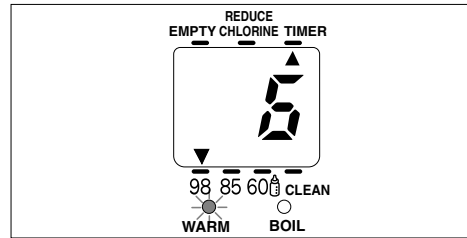

- “6” will be displayed as the hour timer and the WARM indicator will flash. The hours remaining until setting timer is ended will be displayed by 1 hour. (In case setting timer while the water is being boiled, the WARM indicator will flash after the water boils.)

After about 6 hours

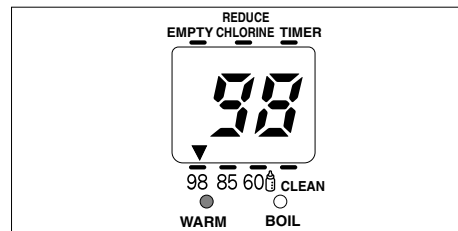

- The TIMER indicator (▲) will light off and the temperature indicator will display. After that, the water will be reboiled. When at the selected warm temperature, the WARM indicator will light up noticeably.

■ To cancel the timer

Press the  button once.

It will switch to BOIL.

MAINTENANCE

WARNING

Do not wet the lid or the pot.

Do not wash the pot thoroughly. Do not immerse the bottom of the pot into the water and do not turn over the pot while its bottom is wet.

Do not wet the cord.

It may cause a short circuit, an electric shock, and an accident.



Do not soak.

Daily maintenance

Filter

It is at the bottom of the pot.
Pull it out and clean it with the brush.
Remove the water slime from the inserted part.
When re-installing, push it down firmly.

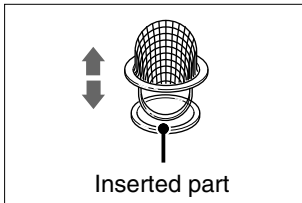

Inner pot

Wipe it softly with sponge and wash it with water.
Clean it with citric acid once a month or three months.

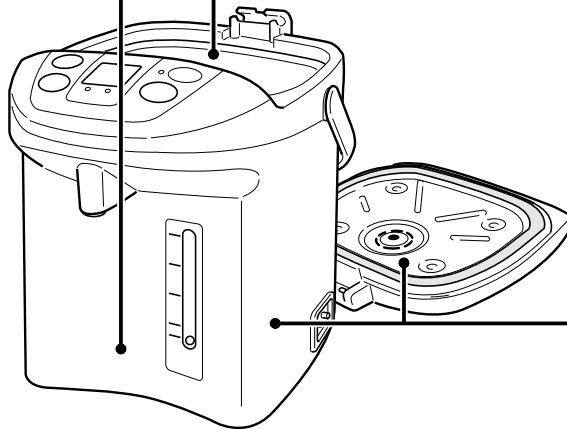

Main body and its lid

Wipe it with damp cloth.

Regarding the water slime (which is colored) or white stains

- White particles (crystallized mineral)
- The changes of water color to milky, black or red, etc.
- Rust-like spots (slightly rusty)
- Roughness

According to the example on the left, these are caused by the minerals in the water. So these are not the changes of color or the bad smell caused by the pot, and the peeling of fluorocarbon.

* Though here does not concern the health problem, please be aware of the maintenance with the citric acid according to the specified period.

Please

- Do not use benzene, cleanser, or the scrubbing brush. These will erode the surface or the coated fluorocarbon - rasin.
- Do not clean the pot with the dish washer or the dish dryer. Such appliances may distort the pot.
- Do not wash it with the detergent. The pot may be smelly.
- Be aware of the pot cleaning. If the dirt is left in the pot, there will be some noise when boiling or it will cause the problem of pouring water.
- In case of not in use for a long time, please leave it naturally dry after the maintenance.

How to clean the pot with the citric acid

1 Put the water into the pot at the level of maximum water. Then fill about 50 grams of citric acid into the water and close the lid.

2 Connect the power cord and press the  button to select "CLEAN".

▶ The CLEAN indicator (▼) flashes and then lights up to start cleaning.

● It takes about 90 minutes for cleaning.

During the clean

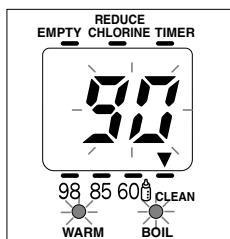

▶ The WARM and BOIL indicators will flash. The remained time of the cleaning will flash in the display of minutes.

This means the pot cleaning is finished.

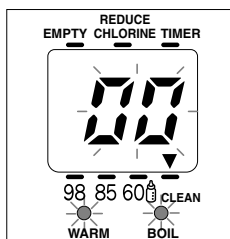

▶ WARM indicator, BOIL indicator, and display will flash quickly.

3 Unplug and pour out all the water. Wipe away the dirt from the pot and wash it with water.

4 To remove the smell of the citric acid, fill the water at the level of maximum water and select the temperature of "98". After that, boil the water and then pour out all the boiled water.

NOTICE

After finishing cleaning the pot with the citric acid, unplug. When connect the power cord next time, it means cleaning the citric acid.

Before disconnecting the power cord, always press

the  button and select the temperature of "98".

Regarding the **PUSH POSITION** for open the lid

How to open the lid

1st step, Push down on the LID LOCK LEVER at the "押す" push position.

2nd step, Lift up the LID LOCK LEVER, then lift the lid up.

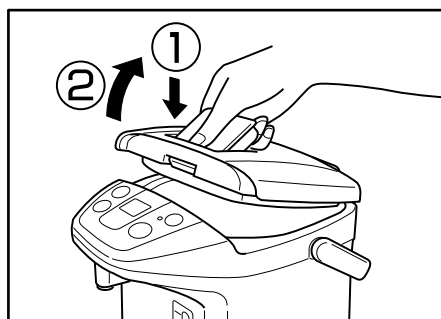
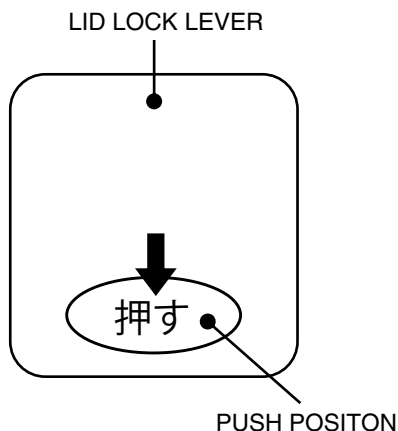

SPECIFICATIONS

| | | |
|---|---|---|
| Power supply | 220 - 240 V a.c. 50 - 60 Hz | |
| MODEL | PLK-25DL, 25VE, 25EL, 25FL, 25FLE and 25VF PLK-25DLI, 25VEI, 25ELI, 25FLI, 25VFI and 25FLEIS | PLK-30DL, 30VE, 30EL, 30FL, 30FLE and 30VF PLK-30DLI, 30VEI, 30ELI, 30FLI, 30VFI and 30FLEIS |
| Power consumption | Boiling 700 W | |
| Capacity | 2.5 L | 3.0 L |
| Type of water pouring | Pouring water with electric power | |
| Outer volume (Width x Depth x Height) | 22.2 cm x 29.7 cm x 23.5 cm | 22.2 cm x 29.7 cm x 25.9 cm |
| Weight (Including the power cord) | About 2.2 kg | About 2.3 kg |
| Fuse temperature | 152°C and 157°C | |

TOSHIBA



NENL1000000173 REV.01