

INSTRUCTION MANUAL

MICROWAVE OVEN

MW3-AG20PE(BK) / MW3-AG20PE(WH)

Please review this instruction manual before operating.

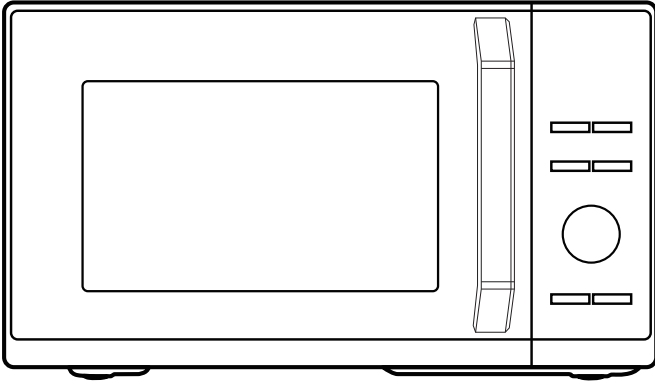

TOSHIBA

LANGUAGES

EN English

DE German

IT Italian

FR France

NL Netherlands

SV Sweden

DA Denmark

CONTENTS

PRODUCT SAFETY

Precautions to avoid possible exposure to excessive microwave energy	EN-01
Specifications	EN-02
Important safety instructions	EN-03
To reduce the risk of injury to persons grounding installation	EN-08
Cleaning	EN-10
Utensils.....	EN-11
Materials you can use in microwave oven	EN-12
Materials can not be used in microwave oven	EN-14

PRODUCT SETTING

Setting up your oven	EN-15
----------------------------	-------

INSTRUCTION FOR USE

Before using for the first time	EN-18
Operation	EN-19
Control panel and features	EN-19
1. Setting the clock	EN-20
2. Setting the kitchen timer	EN-21
3. Microwave cooking.....	EN-21
4. Grilling cooking	EN-22
5. Combination cooking.....	EN-23
6. Defrost by time	EN-24
7. Defrost by weight	EN-24
8. Speedy cooking	EN-25
9. Multi-stage cooking	EN-25

10. Auto menu EN-26

11. Lock function for children EN-28

12. Inquiring function EN-28

CLEANING AND MAINTENANCE

Cleaning EN-29

Trouble shooting EN-31



BEFORE OPERATING THIS PRODUCT, READ, UNDERSTAND, AND FOLLOW THESE INSTRUCTIONS. BE SURE TO SAVE THIS BOOKLIST FOR FUTURE REFERENCE.

PRODUCT SAFETY

PRECAUTIONS TO AVOID POSSIBLE EXPOSURE TO EXCESSIVE MICROWAVE ENERGY

- (a). Do not attempt to operate this oven with the door open since this can result in harmful exposure to microwave energy. It is important not to break or tamper with the safety interlocks.
- (b). Do not place any object between the oven front face and the door or allow soil or cleaner residue to accumulate on sealing surfaces.
- (c). **WARNING:** If the door or door seals are damaged, the oven must not be operated until it has been repaired by a competent person.

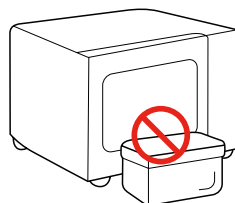

ADDENDUM

If the apparatus is not maintained in a good state of cleanliness, its surface could be degraded and affect the lifespan of the apparatus and lead to a dangerous situation.

SPECIFICATIONS

MODEL	MW3-AG20PE(BK) / MW3-AG20PE(WH)
RATED VOLTAGE/FREQUENCY	230 V~ 50 Hz
MICROWAVE INPUT	1270 W
MICROWAVE OUTPUT	800 W
GRILL	1000 W

ENERGY CONSUMPTION

Product information for power consumption and maximum time to reach applicable low power mode.

Standby mode	0.8 W
--------------	-------

The maximum time needed for the microwave oven to automatically reach the applicable low power mode or condition.	20 minutes
---	------------



NOTE

All pictures in this manual are for illustrative purposes only; these may be slightly different from the purchased equipment, please refer to the actual product.

IMPORTANT SAFETY INSTRUCTIONS



WARNING

To reduce the risk of fire, electric shock, injury to persons or exposure to excessive microwave oven energy when using your appliance, follow basic precautions, including the following:



Read and follow the specific: "**PRECAUTIONS TO AVOID POSSIBLE EXPOSURE TO EXCESSIVE MICROWAVE ENERGY**".



This appliance can be used by children aged from 8 years and above and persons with reduced physical, sensory or mental capabilities or lack of experience and knowledge if they have been given supervision or instruction concerning use of the appliance in a safe way and understand the hazards involved. Children shall not play with the appliance. Cleaning and user maintenance shall not be made by children without supervision.



Keep the appliance and its cord out of reach of children less than 8 years.

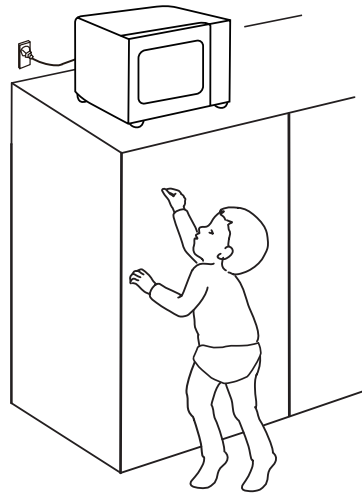



If the supply cord is damaged, it must be replaced by the

IMPORTANT SAFETY INSTRUCTIONS

manufacturer, its service agent or similarly qualified persons in order to avoid a hazard.

 **WARNING:** Ensure that the appliance is switched off before replacing the lamp to avoid the possibility of electric shock.

 **WARNING:** It is hazardous for anyone other than a competent person to carry out any service or repair operation that involves the removal of a cover which gives protection against exposure to microwave energy.

 **WARNING:** Liquids and other foods must not be heated in sealed containers since they are liable to explode.

 When heating food in plastic or paper containers, keep an eye on the oven due to the possibility of ignition.

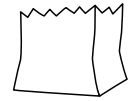

 Only use utensils that are suitable for use in microwave ovens.

 If smoke is emitted, switch off or unplug the appliance and keep the door closed in order to stifle any flames.

 Microwave heating of beverages can result in delayed eruptive boiling, therefore care must be taken when handling the container.

 The contents of feeding bottles and baby food jars shall be stirred or shaken and the temperature

IMPORTANT SAFETY INSTRUCTIONS

checked before consumption, in order to avoid burns.

-
-  The oven should be cleaned regularly and any food deposits removed. Please keep the waveguide area clean. Use soft damp cloth to clean it up when there is food splash residue on the waveguide area or the cavity. Failure to clean food residue may cause innocuous sparking or some smoke in the microwave cavity, discoloration of the cavity may also occur.

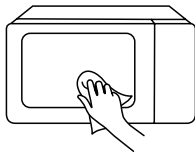

-
-  Failure to maintain the oven in a clean condition could lead to deterioration of the surface that could adversely affect the life of the appliance and possibly

result in a hazardous situation.

-
-  Only use the temperature probe recommended for this oven. (for ovens provided with a facility to use a temperature-sensing probe.)

-
-  The microwave oven must be operated with the decorative door open. (for ovens with a decorative door.)

-
-  This appliance is intended to be used in household and similar applications such as:

1. staff kitchen areas in shops, offices and other working environments;
2. by clients in hotels, motels and other residential type environments;
3. farm houses;
4. bed and breakfast type environments.

IMPORTANT SAFETY INSTRUCTIONS

 The microwave oven is intended for heating food and beverages. Drying of food or clothing and heating of warming pads, slippers, sponges, damp cloth and similar may lead to risk of injury, ignition or fire.

 The rear surface of appliances shall be placed against a wall.

 The temperature of accessible surfaces may be high when the appliance is operating.

 **WARNING:** When the appliance is operated in the combination mode, children should only use the oven under adult supervision due to the temperatures generated.

 The appliance is intended to be used freestanding.

 Eggs in their shell and whole hard-boiled eggs should not be heated in microwave ovens since they may explode, even after microwave heating has ended.

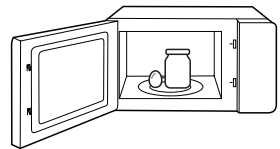



 The microwave oven shall not be placed in a cabinet unless it has been tested in a cabinet.

 Metallic containers for food and beverages are not allowed during microwave cooking.

 The appliance shall not be cleaned with a steam cleaner.

IMPORTANT SAFETY INSTRUCTIONS

-  The appliances are not intended to be operated by means of an external timer or separate remote-control system.
-  The appliance must not be installed behind a decorative door in order to avoid overheating. (This is not applicable for appliances with decorative door.)

READ CAREFULLY AND KEEP FOR
FUTURE REFERENCE
HOUSEHOLD USE ONLY
(NOT FOR COMMERCIAL USE)

TO REDUCE THE RISK OF INJURY TO PERSONS GROUNDING INSTALLATION

This appliance must be grounded. In the event of an electrical short circuit, grounding reduces the risk of electric shock by providing an escape wire for the electric current.

This appliance is equipped with a cord having a grounding wire with a grounding plug. The plug must be plugged into an outlet that is properly installed and grounded.

WARNING - Improper use of the grounding can result in a risk of electric shock. Consult a qualified electrician or serviceman if the grounding instructions are not completely understood or if doubt exists as to whether the appliance is properly grounded.

If it is necessary to use an extension cord, use only a 3-wire extension cord.



DANGER

Electric Shock Hazard:

Touching some of the internal components can cause serious personal injury or death. Do not disassemble this appliance.

TO REDUCE THE RISK OF INJURY TO PERSONS GROUNDING INSTALLATION



WARNING

Electric Shock Hazard:

Improper use of the grounding can result in electric shock. Do not plug into an outlet until appliance is properly installed and grounded.

1. A short power-supply cord is provided to reduce the risks resulting from becoming entangled in or tripping over a longer cord.
2. If a long cord or extension cord is used:
 - (1). The marked electrical rating of the cord set or extension cord should be at least as great as the electrical rating of the appliance.
 - (2). The extension cord must be a grounding-type 3-wire cord.
 - (3). The longer cord should be arranged so that it will not drape over the counter top or tabletop where it can be pulled on by children or tripped over unintentionally.

CLEANING

Be sure to unplug the appliance from the power supply.

1. Clean the cavity of the oven after using with a slightly damp cloth.
2. Clean the accessories in the usual way in soapy water.
3. The door frame and seal and neighbouring parts must be cleaned carefully with a damp cloth when they are dirty.
4. Do not use harsh abrasive cleaners or sharp metal scrapers to clean the oven door glass since they can scratch the surface, which may result in shattering of the glass.
5. Cleaning Tip---For easier cleaning of the cavity walls that the food cooked can touch: Place half a lemon in a bowl, add 300ml (1/2 pint) water and heat on 100% microwave power for 10 minutes. Wipe the oven clean using a soft, dry cloth.

UTENSILS



Personal Injury Hazard:

It is hazardous for anyone other than a competent person to carry out any service or repair operation that involves the removal of a cover which gives protection against exposure to microwave energy. See the instructions on "**Materials you can use in microwave oven**" or "**Materials can not be used in microwave oven**"

There may be certain non-metallic utensils that are not safe to use for microwaving. If in doubt, you can test the utensil in question following the procedure below.

Utensil Test:



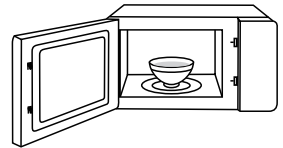



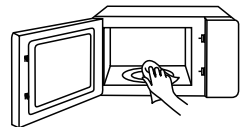









1. Fill a microwave-safe container with 1 cup of cold water (250ml) along with the utensil in question.
2. Cook on maximum power for 1 min.
3. Carefully feel the utensil. If the empty utensil is warm, do not use it for microwave cooking.
4. Do not exceed 1 min cooking time.











KEEP THE CAVITY AND
WAVEGUIDE AREA CLEAN













MATERIALS YOU CAN USE IN MICROWAVE OVEN

UTENSILS	REMARKS	
 Browning dish	Follow manufacturer's instructions. The bottom of browning dish must be at least 3/16 inch (5mm) above the turntable. Incorrect usage may cause the turntable to break.	
 Dinnerware	Microwave-safe only. Follow manufacturer's instructions. Do not use cracked or chipped dishes.	
 Glass jars	Always remove lid. Use only to heat food until just warm. Most glass jars are not heat resistant and may break.	
 Glassware	Heat-resistant oven glassware only. Make sure there is no metallic trim. Do not use cracked or chipped dishes.	
 Oven cooking bags	Follow manufacturer's instructions. Do not close with metal tie. Make slits to allow steam to escape.	
 Paper plates and cups	Use for short-term cooking/warming only. Do not leave oven unattended while cooking.	
 Paper towels	Use to cover food for reheating and absorbing fat. Use with supervision for a short-term cooking only.	
 Parchment paper	Use as a cover to prevent splattering or a wrap for steaming.	

MATERIALS YOU CAN USE IN MICROWAVE OVEN

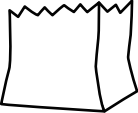
UTENSILS	REMARKS
 <p data-bbox="172 451 240 475">Plastic</p>	<p data-bbox="350 355 900 496">Microwave-safe only. Follow the manufacturer's instructions. Should be labeled "Microwave Safe". Some plastic containers soften, as the food inside gets hot. "Boiling bags" and tightly closed plastic bags should be slit, pierced or vented as directed by package.</p> 
 <p data-bbox="145 638 267 662">Plastic wrap</p>	<p data-bbox="350 555 898 638">Microwave-safe only. Use to cover food during cooking to retain moisture. Do not allow plastic wrap to touch food.</p> 
 <p data-bbox="132 801 280 825">Thermometers</p>	<p data-bbox="350 750 889 774">Microwave-safe only (meat and candy thermometers).</p> 
 <p data-bbox="153 960 258 984">Wax paper</p>	<p data-bbox="350 898 820 949">Use as a cover to prevent splattering and retain moisture.</p> 

MATERIALS CAN NOT BE USED IN MICROWAVE OVEN

UTENSILS	REMARKS
 Aluminum tray	May cause arcing. Transfer food into microwave-safe dish. 
 Food carton with metal handle	May cause arcing. Transfer food into microwave-safe dish. 
 Metal or metal trimmed utensils	Metal shields the food from microwave energy. Metal trim may cause arcing. 
 Metal twist ties	May cause arcing and could cause a fire in the oven. 
 Paper bags	May cause a fire in the oven. 
 Plastic foam	Plastic foam may melt or contaminate the liquid inside when exposed to high temperature. 
 Wood	Wood will dry out when used in the microwave oven and may split or crack. 

PRODUCT SETTING

NAMES OF MICROWAVE OVEN PARTS AND ACCESSORIES

Remove the oven and all materials from the carton and oven cavity.

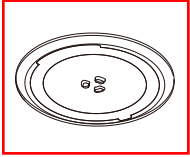

Glass tray

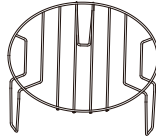

Grill Rack(Can not be used in microwave function and must be placed on the glass tray)

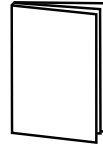

Instruction Manual

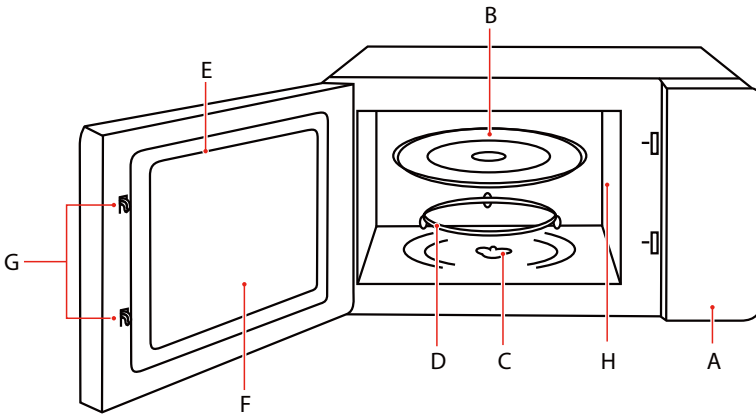

A. Control panel

B. Glass tray

C. Turntable shaft

D. Turntable ring assembly

E. Door assembly

F. Observation window

G. Safety interlock system

H. Waveguide cover



NOTE

In case of any differences between the appliance and the pictures in this manual, the product shall prevail.

TURNTABLE INSTALLATION

Cleaning the cooking compartment and putting the turntable in place.

For new installations, make sure all packaging and shipping tape has been removed from the turntable shaft.

Before using the appliance to prepare food for the first time, you will need to put the turntable in place correctly. You must clean the cooking compartment and accessories.

How to put the turntable in place:

1. Place the turntable ring assembly^③ into the recess in the cooking compartment.
2. Place the glass turntable^① on the turntable ring assembly^③. Fit the raised, curved lines in the center of the glass turntable bottom between the three spokes of the shaft. Make sure that the glass turntable^① engages in the turntable shaft^② in the center of the cooking compartment floor. The rollers on the shaft should fit inside the turntable bottom ridge.

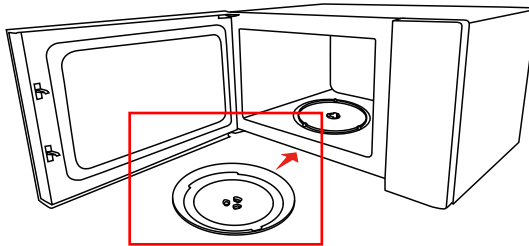
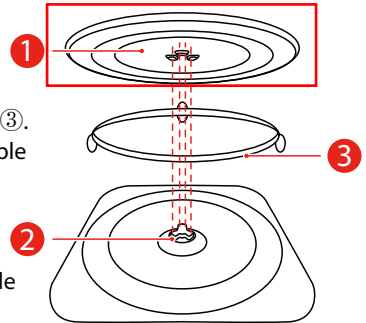

NOTE

- Never use the appliance without the turntable. Make sure that it is properly engaged. The turntable can turn clockwise or anti-clockwise.
- Never place the glass turntable upside down. The glass turntable should never be restricted.
- Both glass turntable and turntable ring assembly must always be used during cooking.
- All food and containers of food are always placed on the glass turntable for cooking.
- Never restrict the movement of the turntable.
- If glass turntable or turntable ring assembly cracks or breaks, contact your nearest authorized service center.

COUNTERTOP INSTALLATION

Remove all packing material and accessories. Examine the oven for any damage such as dents or broken door. Do not install if oven is damaged.

Cabinet: Remove any protective film found on the microwave oven cabinet surface. Do not remove the waveguide cover that is attached to the oven cavity to protect the magnetron.

INSTALLATION

1. Select a level surface that provide enough open space for the intake and/or outlet vents.
 - a. The minimum installation height is 85cm.
 - b. The rear surface of appliance shall be placed against a wall. Leave a minimum clearance of 30cm above the oven. A minimum clearance of 20cm is required between the oven and any adjacent walls.
 - c. Do not remove the legs from the bottom of the oven.
 - d. Blocking the intake and/or outlet openings can damage the oven.
 - e. Place the oven as far away from radios and TV as possible. Operation of microwave oven may cause interference to your radio or TV reception.

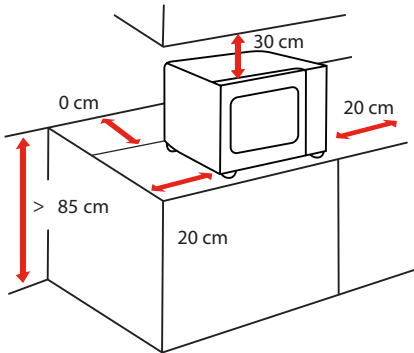

SIDE	DISTANCE CM
Top	30cm
Left	20cm
Right	20cm
Behind	0cm
Front	Open

2. Plug microwave oven into a standard household outlet. Be sure the voltage and the frequency is the same as the voltage and the frequency on the rating label.



NOTE

- Do not install oven over a range cooktop or other heat-producing appliance. If installed near or over a heat source, the oven could be damaged and the warranty would be void.

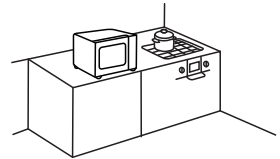

The accessible surface may be hot during operation

INSTRUCTION FOR USE

BEFORE USING FOR THE FIRST TIME

It is normal that the oven may produce unpleasant odors when it is used for the first time.

This section tells you what you need to do before using your microwave to prepare food for the first time. Read the section entitled "**PRODUCT SAFETY**" beforehand.

Before you can use your new appliance, you will need to put the turntable in place correctly. You must also clean the cooking compartment and accessories.



NOTE

- Never use the appliance without the turntable.
- Make sure that it is properly engaged. The turntable can turn clockwise or anti-clockwise.

OPERATION

CONTROL PANEL AND FEATURES

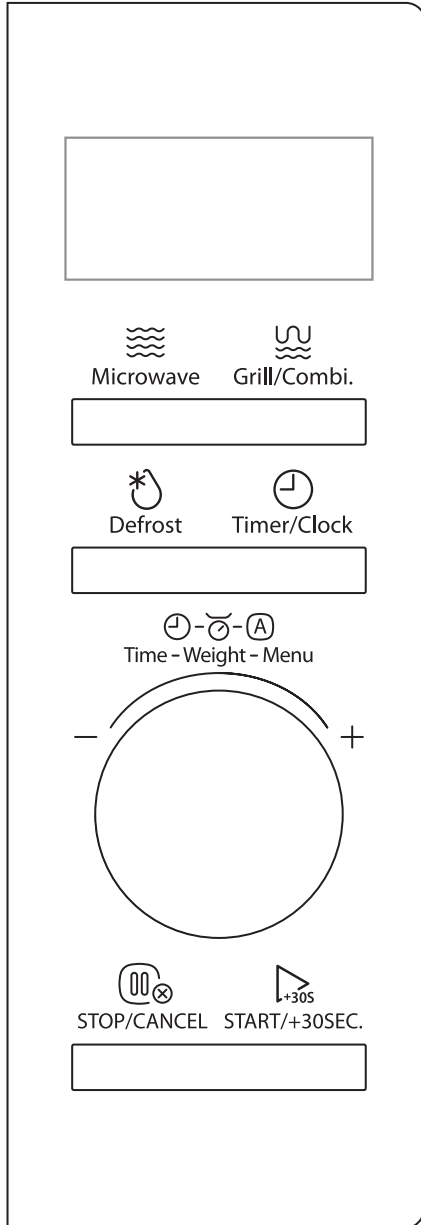

1. SETTING THE CLOCK



a Press  twice, "00:00" will display.

Timer/Clock

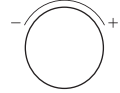

b Turn the knob to set the hour figures.



c Press  or  to confirm the hour figures.

Timer/Clock

or

START/+30SEC.

to





or

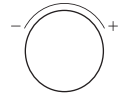

d Turn the knob to set the minute figures.



e Press  or  to confirm. The clock is set.

Timer/Clock

or

START/+30SEC.

to



or



- The clock is a 24-hour display. If the clock is not set, it will not work when powered.
- To reset the clock, please repeat step a to step e.

2. SETTING THE KITCHEN TIMER

a Press  once, "00:00" will display.



b Turn the knob to set the desired time.
The maximum time value is "95:00".

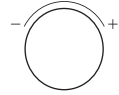

c Press  to confirm. The timer starts counting down.



NOTE

- The kitchen timer is a timer.
- Any other program can't be set during the kitchen timer.

3. MICROWAVE COOKING

5 power levels are available.

LEVEL	POWER	DISPLAY
1	100%	P100
2	80%	P80
3	50%	P50
4	30%	P30
5	10%	P10

a Press  repeatedly to choose the power level.



or
Press  once, and then turn the knob to set the power level.





The 5 power levels are available.

b Press  to confirm the power level.

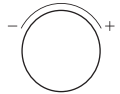

c Turn the knob to set the cooking time, the maximum time value is "95:00".



d Press  to start cooking.



4. GRILLING COOKING

a Press  once, "G-1" will display.



b Press  to confirm the mode.



c Turn the knob to set the cooking time, the maximum time value is "95:00".

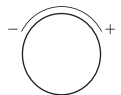

d Press  to start cooking.

START/+30SEC.



• The buzzer will sound to remind you to turn the food over during cooking. If no operation, the oven will continue working.

5. COMBINATION COOKING

a Press  repeatedly to choose the cooking mode you want. "C-1, C-2" are available.

Grill/Combi.

or
Press  once, and then turn the knob to choose the cooking mode.



Grill/Combi.



b Press  to confirm the mode.

START/+30SEC.

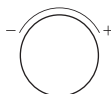
c Turn the knob to set the cooking time, the maximum time value is "95:00".



d Press  to start cooking.

START/+30SEC.

COMBINATION COOKING CHART

FUNCTION	DISPLAY	MICROWAVE POWER	GRILL POWER
Combi. 1	C-1	55%	45%
Combi. 2	C-2	36%	64%

6. DEFROST BY TIME

- a Press  Defrost twice, and then "dEF2" will display.



- b Turn the knob to set the desired defrost time, the maximum time value is "95:00".

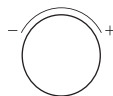

- c Press  to start defrosting.

START/+30SEC.



NOTE

- The buzzer will sound to remind you of turning over the food during defrosting. If no operation, the oven will continue working.
- The defrost power is P30 and it cannot be changed.

7. DEFROST BY WEIGHT

- a Press  Defrost once, and then "dEF1" will display.



- b Turn the knob to set the weight of the food, the range of weight is 100g to 2000g.



- c Press  to start defrosting.

START/+30SEC.



8. SPEEDY COOKING

a Turn the knob left to set a cooking time at 100% power.

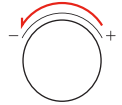

b Continue to turn the knob to adjust the cooking time, the maximum time value is "95:00".



c Press  to start cooking.

START/+30SEC.



a Press  to cook food at 100% power level for 30 seconds. Each press on the same key can increase 30 seconds and the maximum time value is "95:00".

START/+30SEC.



9. MULTI-STAGE COOKING

Example: Defrost food for 5 minutes and then cook with 80% microwave power for 7 minutes.

a Press  twice, "dEF2" will display.

Defrost



b Turn the knob to set the desired defrost time to 5 minutes.



c Press  repeatedly until "P80" displays.

Microwave



d Press  to confirm the power level.

START/+30SEC.



e Turn the knob to set the cooking time to 7 minutes.

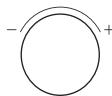

f Press  to start cooking.

START/+30SEC.

START/+30SEC.



NOTE

- Two cooking stages can be set in multi-stage cooking.
- If you set the defrost function, it will work automatically in the first stage.
- The kitchen timer, and auto menu cannot be set as one of the multi-stage.

10. AUTO MENU

a In standby mode, turn the knob right once, and then "A-1" will display.

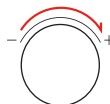

b Continue to turn the knob to choose the menu you need. The 8 auto menus are available.

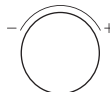

c Press  to confirm.

START/+30SEC.

START/+30SEC.

d Turn the knob to set the weight of the food.



e Press  to start cooking.

START/+30SEC.



START/+30SEC.

AUTO MENU CHART

MENU	WEIGHT/ AMOUNT	DISPLAY	POWER LEVEL
A-1 Auto Reheat	200g 400g 600g	200g 400g 600g	P100
A-2 Vegetable	200g 300g 400g	200g 300g 400g	P100
A-3 Fish	250g 350g 450g	250g 350g 450g	P80
A-4 Meat	250g 350g 450g	250g 350g 450g	P100
A-5 Pasta	50g (with 450g cold water) 100g (with 800g cold water)	50g 100g	P80
A-6 Potato	200g 400g 600g	200g 400g 600g	P100
A-7 Frozen Pizza	200g 400g	200g 400g	P100/Grill
A-8 Soup	200ml 400ml	200 400	P80

11. LOCK FUNCTION FOR CHILDREN

You can use this function to prevent children from accidentally turning the oven on.

- a** To activate the lock:
In standby mode, press and hold  STOP/CANCEL for three seconds.
A beep sounds and the locked icon will display.



- b** To deactivate the lock:
In the locked state, press and hold  STOP/CANCEL for three seconds.
A beep sounds.



12. INQUIRING FUNCTION

- a** When oven is cooking, press  Timer/Clock the current time will display for three seconds in the display.



- b** In the microwave cooking state, press  Microwave to inquire about the power level. It will display for three seconds.



- c** In the grilling, and combination cooking state, press  Grill/Combi. to inquire about the cooking mode. It will display for three seconds.



CLEANING AND MAINTENANCE

CLEANING

With good care and cleaning, your appliance will retain its appearance and remain fully functioning for a long time to come. We will explain here how you should correctly care for and clean your appliance.



WARNING

- Scratched glass in the appliance door may develop into a crack. Do not use a glass scraper, sharp or abrasive cleaning aids or detergents.
- The surface of the appliance may become damaged if it is not cleaned properly. Microwave energy may escape. Clean the appliance on a regular basis, and remove any food remnants immediately.
- Do not immerse the appliance in water or clean under a jet of water.

Cleaning agent

To ensure that the different surfaces are not damaged by using the wrong cleaning agent, observe the information in the table. Wash new sponge cloths thoroughly before use.

Do not use:



Harsh or abrasive cleaning agents



Metal or glass scrapers to clean the door panels



Metal or glass scrapers to clean the door seal



Hard scouring pads or sponges



Cleaning agents with a high alcohol content

APPLIANCE FRONT

Hot soapy water:

Clean using a dish cloth and then dry with a soft cloth. Do not use metal or glass scrapers for cleaning.

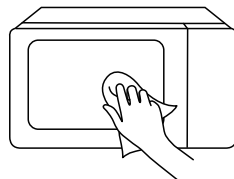

APPLIANCE FRONT WITH STAINLESS STEEL

Hot soapy water:

Clean using a dish cloth and then dry with a soft cloth. Remove splashes and patches of limescale, grease, starch and albumin immediately. Corrosion can form under these patches or splashes. Do not use glass cleaners or metal or glass scrapers for cleaning.

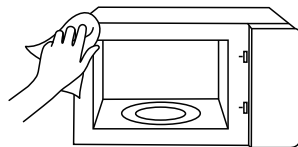

COOKING COMPARTMENT MADE OF STAINLESS STEEL

Hot soapy water or vinegar solution:

Clean using a dish cloth and then dry with a soft cloth. Do not use oven spray or any other aggressive oven cleaners or abrasive materials. Scouring pads, rough sponges and pan cleaners are also unsuitable. These items scratch the surface. Allow the interior surfaces to dry completely.

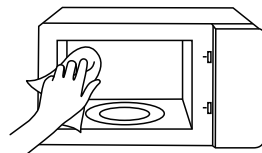

RECESS IN THE COOKING COMPARTMENT

Damp cloth:

Water must not be allowed to run into the appliance through the turntable drive. Dry the turntable drive with a cloth.

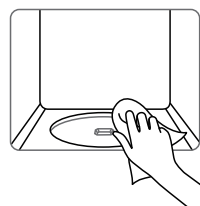

TURNTABLE AND ROLLER RING

Hot soapy water:

When placing the turntable back into its recess, it must engage properly.

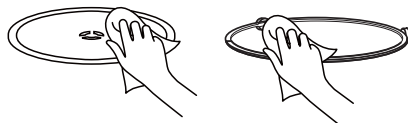

DOOR PANELS

Glass cleaner:

Clean with a dish cloth. Do not use glass scrapers.

TROUBLE SHOOTING

Check your problem by using the chart below and try the solutions for each problem.

If the microwave oven still does not work properly, contact the nearest authorized service center.

TROUBLE	POSSIBLE CAUSE	POSSIBLE REMEDY
Oven will not start	<ul style="list-style-type: none"> a. Electrical cord for oven is not plugged in. b. Door is open. c. Wrong operation is set. 	<ul style="list-style-type: none"> a. Plug into the outlet. b. Close the door and try again. c. Check instructions
Arcing or sparking	<ul style="list-style-type: none"> a. Materials to be avoided in microwave oven were used. b. The oven is operated when empty. c. Spilled food remains in the cavity. 	<ul style="list-style-type: none"> a. Use microwave-safe cookware only. b. Do not operate with oven empty. c. Clean cavity with soft damp cloth.
Unevenly cooked foods	<ul style="list-style-type: none"> a. Materials to be avoided in microwave oven were used. b. Food is not defrosted completely. c. Cooking time, power level is not suitable. d. Food is not turned or stirred. 	<ul style="list-style-type: none"> a. Use microwave-safe cookware only. b. Completely defrost food. c. Use correct cooking time, power level. d. Turn or stir food.
Overcooked foods	Cooking time, power level is not suitable.	Use correct cooking time, power level.
Undercooked foods	<ul style="list-style-type: none"> a. Materials to be avoided in microwave oven were used. b. Food is not defrosted completely. c. Oven ventilation ports are restricted. d. Cooking time, power level is not suitable. 	<ul style="list-style-type: none"> a. Use microwave-safe cookware only. b. Completely defrost food. c. Check to see that oven ventilation ports are not restricted. d. Use correct cooking time, power level
Improper defrosting	<ul style="list-style-type: none"> a. Materials to be avoided in microwave oven were used. b. Cooking time, power level is not suitable. c. Food is not turned or stirred. 	<ul style="list-style-type: none"> a. Use microwave-safe cookware only. b. Use correct cooking time, power level. c. Turn or stir food.



According to Waste of Electrical and Electronic Equipment (WEEE) directive, WEEE should be separately collected and treated. If at any time in future you need to dispose of this product please do NOT dispose of this product with household waste. Please send this product to WEEE collecting points where available.

#DetailsMatter

BEDIENUNGSANLEITUNG

MIKROWELLENHERD

MW3-AG20PE(BK) / MW3-AG20PE(WH)

Bitte lesen Sie diese Bedienungsanleitung vor der Inbetriebnahme.

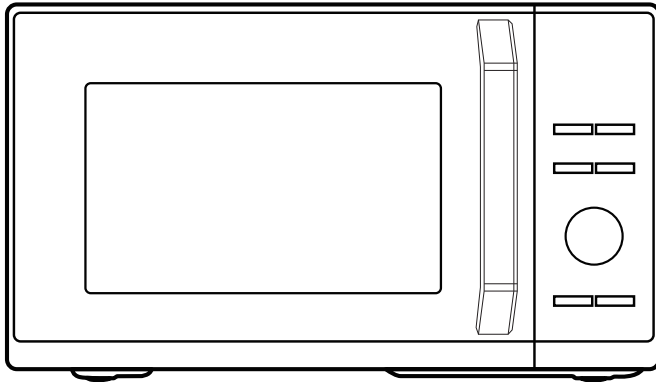

TOSHIBA

INHALT

PRODUKTSICHERHEIT

Vorsichtsmaßnahmen zur Vermeidung einer möglichen Exposition gegenüber übermäßiger Mikrowellenenergie	DE-01
Wichtige Sicherheitshinweise.....	DE-03
Zur Verringerung des Verletzungsrisikos für Personen Erdungsanlage	DE-08
Reinigung.....	DE-10
Utensilien	DE-11
Materialien, die Sie im Mikrowellenherd verwenden können	DE-12
Die Materialien können nicht im Mikrowellenherd verwendet werden.....	DE-14

PRODUKTEINSTELLUNG

Einrichten des Backofens	DE-15
--------------------------------	-------

GEBRAUCHSANWEISUNG

Vor dem ersten Gebrauch	DE-19
Betrieb.....	DE-20
1.Uhrzeit einstellen	DE-21
2. Einstellen des küchentimers	DE-22
3.Garen im mikrowellenofen	DE-22
4.GRILLEN	DE-23
5.Kombiniertes kochen	DE-24
6. Auftauen nach zeit	DE-25
7. Abtauen nach Zeit	DE-25
8.Schnelles kochen	DE-26

9.Mehrstufiges garen	DE-26
10.Auto-menü	DE-27
11. Kindersicherung	DE-29
12.Abfragefunktion	DE-29
Reinigung.....	DE-30

WARTUNG

Fehlersuche	DE-32
-------------------	-------



HINWEIS

BEVOR SIE DIESES PRODUKT IN BETRIEB NEHMEN, SOLLTEN SIE DIESE ANLEITUNG LESEN, VERSTEHEN UND BEFOLGEN. BEWAHREN SIE DIESE BÜCHERLISTE ZUM SPÄTEREN NACHSCHLAGEN AUF.

PRODUKTSICHERHEIT

VORKEHRUNGEN ZUR VERMEIDUNG EINER MÖGLICHEN EXPOSITION GEGENÜBER ÜBERMÄSSIGER MIKROWELLENENERGIE

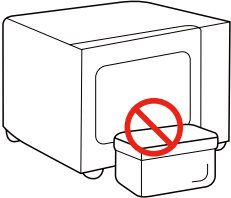
- (a). Versuchen Sie nicht, diesen Ofen bei geöffneter Tür zu betreiben, da dies zu einer schädlichen Exposition gegenüber Mikrowellenenergie führen kann. Es ist wichtig, dass die Sicherheitsverriegelungen nicht zerstört oder manipuliert werden.
- (b). Legen Sie keine Gegenstände zwischen Ofenfront und Tür und achten Sie darauf, dass sich keine Schmutz- oder Reinigungsmittelreste auf den Dichtungsflächen ansammeln.
- 
- (c). **WARNUNG:** Wenn die Tür oder die Türdichtungen beschädigt sind, darf der Backofen nicht in Betrieb genommen werden, bis er von einer kompetenten Person repariert wurde.

ADDENDUM

Wenn das Gerät nicht in einem sauberen Zustand gehalten wird, kann seine Oberfläche beschädigt werden, was die Lebensdauer des Geräts beeinträchtigt und zu einer gefährlichen Situation führt.

SPEZIFIKATIONEN

MODELL	MW3-AG20PE(BK) / MW3-AG20PE(WH)
SPANNUNG/FREQUENZ	230 V~ 50 Hz
NENNEINGANGSLEISTUNG (MIKROWELLE)	1270 W
NENNAUSGANGSLEISTUNG (MIKROWELLE)	800 W
NENNEINGANGSLEISTUNG (GRILL)	1000 W

STROMVERBRAUCH

Produktinformation zum Stromverbrauch und zur maximalen Zeit bis zum Erreichen des jeweiligen Energiesparmodus.

Standby-Modus	0.8 W
---------------	-------

Die maximale Zeit, die der Mikrowellenherd benötigt, um automatisch den entsprechenden Energiesparmodus oder -zustand zu erreichen.	20 Minuten
---	------------



HINWEIS

Alle Abbildungen in diesem Handbuch dienen nur der Veranschaulichung; sie können sich geringfügig vom gekauften Gerät unterscheiden, bitte beziehen Sie sich auf das tatsächliche Produkt.

WICHTIGE SICHERHEITSANWEISUNGEN



WARNUNG

Um das Risiko eines Brandes, eines elektrischen Schlages, einer Verletzung von Personen oder einer übermäßigen Belastung durch Mikrowellenenergie bei der Verwendung Ihres Gerätes zu verringern, beachten Sie die folgenden grundlegenden Vorsichtsmaßnahmen:



Lesen und beachten Sie das Spezifische:
„VORSICHTSMASSNAHMEN ZUR VERMEIDUNG EINER MÖGLICHEN EXPOSITION GEGENÜBER ÜBERMÄSSIGER MIKROWELLENENERGIE“.



Dieses Gerät kann von Kindern ab 8 Jahren und darüber sowie von Personen mit verringerten physischen, sensorischen oder geistigen Fähigkeiten oder Mangel an Erfahrung und Wissen benutzt werden, wenn sie beaufsichtigt oder bezüglich des sicheren Gebrauchs des Geräts unterwiesen wurden und die daraus resultierenden Gefahren verstehen. Kinder dürfen nicht mit dem Gerät spielen.

Die Reinigung und Wartung durch den Benutzer darf nicht von Kindern ohne Aufsicht durchgeführt werden.



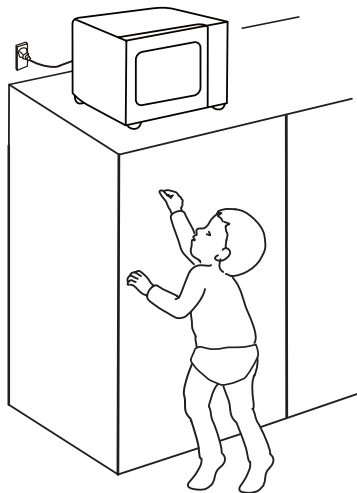

Bewahren Sie das Gerät und sein Kabel außerhalb der Reichweite von Kindern unter 8 Jahren auf.





WICHTIGE SICHERHEITSANWEISUNGEN

 Wenn das Netzkabel beschädigt ist, muss es vom Hersteller, seinem Kundendienst oder ähnlich qualifizierten Personen ersetzt werden, um Gefahren zu vermeiden.

 **WARNUNG:** Um die Möglichkeit eines Stromschlags zu vermeiden, vergewissern Sie sich, dass das Gerät ausgeschaltet ist, bevor Sie die Lampe austauschen.

 **WARNUNG:** Es ist gefährlich, wenn eine nicht fachkundige Person Wartungs- oder Reparaturarbeiten durchführt, bei denen eine Abdeckung entfernt werden muss, die vor der Einwirkung von Mikrowellenenergie schützt.

 **WARNUNG:** Flüssigkeiten und andere Lebensmittel dürfen nicht in verschlossenen Behältern erhitzt werden, da sie explodieren können.

 Wenn Sie Lebensmittel in Plastik- oder Papierbehältern erhitzen, sollten Sie den Ofen im Auge behalten, da die Möglichkeit einer Entzündung besteht.

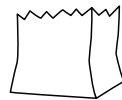



 Verwenden Sie nur Utensilien, die für die Verwendung in Mikrowellenherden geeignet sind.

 Wenn Rauch austritt, schalten Sie das Gerät aus oder ziehen Sie den Netzstecker und halten Sie die Tür geschlossen, um eventuelle Flammen zu ersticken.

 Das Erhitzen von Getränken in der Mikrowelle kann zu einem verzögerten Siedepunkt führen, daher ist bei der Handhabung des Behälters Vorsicht geboten.

WICHTIGE SICHERHEITSANWEISUNGEN

 Der Inhalt von Fläschchen und Gläsern mit Baby-nahrung muss vor dem Verzehr umgerührt oder geschüttelt und die Temperatur überprüft werden, um Verbrennungen zu vermeiden.

 **WARNUNG:** Wenn das Gerät im Kombinationsmodus betrieben wird, sollten Kinder den Ofen wegen der entstehenden Temperaturen nur unter Aufsicht von Erwachsenen benutzen.

 Wird der Backofen nicht sauber gehalten, kann dies zu einer Verschlechterung der Oberfläche führen, die sich negativ auf die Lebensdauer des Geräts auswirken und möglicherweise zu einer gefährlichen Situation führen kann.

 Verwenden Sie nur den für diesen Ofen empfohlenen Temperaturfühler. (bei Backöfen mit der

Möglichkeit, einen Temperaturfühler zu verwenden)

 Der Mikrowellenherd muss mit geöffneter Ziertür betrieben werden. (für Backöfen mit Ziertür)

 Dieses Gerät ist für die Verwendung in Haushalten und ähnlichen Anwendungen vorgesehen, wie z. B.:

1. in Küchenbereichen für Mitarbeiter in Geschäften, Büros und anderen Arbeitsumgebungen;
2. von Kunden in Hotels, Motels und anderen Wohnumgebungen;
3. in Bauernhäusern;
4. in Bed & Breakfast-ähnlichen Umgebungen.

 Der Mikrowellenherd ist für die Erwärmung von Speisen und Getränken bestimmt. Das Trocknen von Lebensmitteln oder Kleidung und das Erhitzen von Wärmekissen,

WICHTIGE SICHERHEITSANWEISUNGEN

Hausschuhen, Schwämmen, feuchten Tüchern und Ähnlichem kann zu Verletzungs-, Entzündungs- oder Brandgefahr führen.

 Das Gerät ist für den freistehenden Betrieb vorgesehen.

 Die Rückwand der Geräte muss an einer Wand angebracht sein.

 Die Temperatur der zugänglichen Oberflächen kann hoch sein, wenn das Gerät in Betrieb ist.

 Der Backofen sollte regelmäßig gereinigt und Lebensmittelablagerungen entfernt werden. Bitte halten Sie den Bereich des Hohlleiters sauber. Reinigen Sie das Gerät mit einem weichen, feuchten Tuch, wenn sich Speisereste im Bereich des Wellenleiters oder im Hohlraum befinden;

wenn Sie die Speisereste nicht entfernen, kann es zu harmlosen Funken oder Rauch im Mikrowellenhohlraum kommen; außerdem kann sich der Hohlraum verfärben.

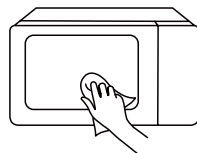

 Eier in der Schale und ganze hartgekochte Eier sollten nicht in der Mikrowelle erhitzt werden, da sie explodieren können, auch wenn die Mikrowellenerhitzung beendet ist.

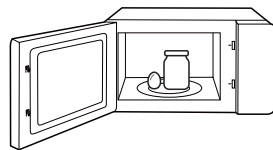



 Der Mikrowellenherd darf nur dann in einen Schrank eingebaut werden, wenn er in einem Schrank getestet wurde.

WICHTIGE SICHERHEITSANWEISUNGEN

 Metallische Behälter für Lebensmittel und Getränke sind beim Garen in der Mikrowelle nicht erlaubt.

 Das Gerät darf nicht mit einem Dampfreiniger gereinigt werden.

 Das Gerät ist nicht dazu bestimmt, mit einer externen Zeitschaltuhr oder einem separaten Fernbedienungssystem betrieben zu werden.

 Das Gerät darf nicht hinter einer Ziertür eingebaut werden, um eine Überhitzung zu vermeiden. (Dies gilt nicht für Geräte mit Ziertür.)

**SORGFÄLTIG LESEN UND FÜR SPÄTERE
VERWENDUNG AUFBEWAHREN**

UM DIE VERLETZUNGSGEFAHR FÜR PERSONEN ZU VERRINGERN ERDUNGSANLAGE

Dieses Gerät muss geerdet werden. Im Falle eines Kurzschlusses verringert die Erdung die Gefahr eines elektrischen Schlags, da sie eine Ableitung für den elektrischen Strom bietet.

Dieses Gerät ist mit einem Kabel mit Erdungsdraht und einem Erdungsstecker ausgestattet. Der Stecker muss in eine ordnungsgemäß installierte und geerdete Steckdose eingesteckt werden.

WARNUNG – Bei unsachgemäßer Verwendung der Erdung besteht die Gefahr eines Stromschlags. Wenden Sie sich an einen qualifizierten Elektriker oder Servicetechniker, wenn Sie die Erdungsanweisungen nicht vollständig verstanden haben oder wenn Sie Zweifel daran haben, ob das Gerät richtig geerdet ist. Wenn ein Verlängerungskabel erforderlich ist, verwenden Sie nur ein 3-adriges Verlängerungskabel.



GEFAHR

Gefahr eines elektrischen Schlages:
Die Berührung einiger interner Komponenten kann zu schweren Verletzungen oder zum Tod führen.
Nehmen Sie das Gerät nicht auseinander.

UM DIE VERLETZUNGSGEFAHR FÜR PERSONEN ZU VERRINGERN ERDUNGSANLAGE



WARNUNG

Gefahr eines elektrischen Schlages:

Die unsachgemäße Verwendung der Erdung kann zu einem Stromschlag führen. Schließen Sie das Gerät erst dann an eine Steckdose an, wenn es ordnungsgemäß installiert und geerdet ist.

1. Ein kurzes Netzkabel ist vorgesehen, um die Gefahr zu verringern, sich in einem längeren Kabel zu verfangen oder darüber zu stolpern.
2. Wenn ein langes Kabel oder ein Verlängerungskabel verwendet wird:
 - (1). Die angegebene elektrische Leistung des Kabelsatzes oder Verlängerungskabels sollte mindestens so groß sein wie die elektrische Leistung des Geräts.
 - (2). Das Verlängerungskabel muss ein geerdetes 3-adriges Kabel sein.
 - (3). Die längere Schnur sollte so angebracht werden, dass sie nicht über die Arbeits- oder Tischplatte hängt, wo sie von Kindern angezogen werden oder über die sie unbeabsichtigt stolpern kann.

REINIGUNG

Trennen Sie das Gerät unbedingt vom Stromnetz.

1. Reinigen Sie den Garraum des Backofens nach dem Gebrauch mit einem leicht feuchten Tuch.
2. Reinigen Sie das Zubehör wie gewohnt in Seifenlauge.
3. Der Türrahmen und die Dichtung sowie die angrenzenden Teile müssen bei Verschmutzung sorgfältig mit einem feuchten Tuch gereinigt werden.
4. Verwenden Sie keine aggressiven Scheuermittel oder scharfen Metallschaber, um das Glas der Ofentür zu reinigen, da diese die Oberfläche zerkratzen können, was zu einem Glasbruch führen kann.
5. Reinigungstipp---Zur leichteren Reinigung der Wände des Garraums, die das Gargut berühren kann: Eine halbe Zitrone in eine Schüssel geben, 300 ml Wasser hinzufügen und 10 Minuten lang auf 100 % Mikrowellenleistung erhitzen. Wischen Sie den Backofen mit einem weichen, trockenen Tuch sauber.

UTENSILIEN



Gefahr von Körperverletzungen:

Es ist gefährlich, wenn eine nicht fachkundige Person Wartungs- oder Reparaturarbeiten durchführt, bei denen eine Abdeckung entfernt werden muss, die vor der Einwirkung von Mikrowellenenergie schützt. Siehe die Anweisungen unter „**Materialien, die Sie im Mikrowellenherd verwenden können**“ oder „**Materialien, die nicht für den Mikrowellenherd geeignet sind**“

Bestimmte nicht-metallische Utensilien sind für die Mikrowelle nicht geeignet. Im Zweifelsfall können Sie das betreffende Utensil wie folgt testen.

Utensilien-Test:

1. Füllen Sie einen mikrowellengeeigneten Behälter mit 1 Tasse kaltem Wasser (250 ml) und dem betreffenden Utensil.
2. 1 Minute lang auf höchster Stufe kochen.
3. Fühlen Sie das Utensil vorsichtig. Wenn das leere Kochgeschirr warm ist, darf es nicht zum Kochen in der Mikrowelle verwendet werden.
4. Die Garzeit sollte 1 Minute nicht überschreiten.

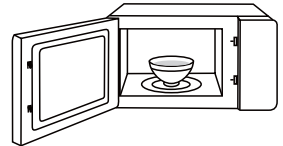

DEN HOHLRAUM UND DEN
BEREICH DES HOHLLEITERS
SAUBER HALTEN

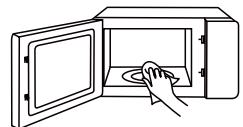

MATERIALIEN, DIE SIE IM MIKROWELLEN-HERD VERWENDEN KÖNNEN

UTENSILIEN	BEMERKUNGEN
 Bräunungsschale	Befolgen Sie die Anweisungen des Herstellers. Der Boden der Bräunungsschale muss sich mindestens 5 mm (3/16 Zoll) über dem Drehteller befinden. Bei unsachgemäßem Gebrauch kann der Plattenteller kaputt gehen. 
 Essgeschirr	Nur für die Mikrowelle geeignet. Befolgen Sie die Anweisungen des Herstellers. Verwenden Sie kein gesprungenes oder zerbrochenes Geschirr. 
 Glasgefäße	Nehmen Sie immer den Deckel ab. Nur zum Erhitzen von Speisen verwenden, bis sie gerade warm sind. Die meisten Glasgefäße sind nicht hitzebeständig und können zerbrechen. 
 Glaswaren	Nur hitzebeständige Glaswaren für den Ofen. Vergewissern Sie sich, dass keine metallischen Verzierungen vorhanden sind. Verwenden Sie kein gesprungenes oder zerbrochenes Geschirr. 
 Backofen-Kochbeutel	Befolgen Sie die Anweisungen des Herstellers. Nicht mit Metallbändern verschließen. Schlitzte machen, damit der Dampf entweichen kann. 
 Pappteller und -becher	Nur zum kurzzeitigen Kochen/Aufwärmen verwenden. Lassen Sie den Ofen während des Garens nicht unbeaufsichtigt. 
 Papierhandtücher	Zum Abdecken von Speisen zum Aufwärmen und Absorbieren von Fett. Nur unter Aufsicht für kurzzeitiges Kochen verwenden. 
 Pergamentpapier	Verwenden Sie es als Abdeckung, um Spritzer zu vermeiden, oder als Umschlag zum Dämpfen. 

MATERIALIEN, DIE SIE IM MIKROWELLENHERD VERWENDEN KÖNNEN

UTENSILIEN

BEMERKUNGEN



Kunststoff

Nur für die Mikrowelle geeignet. Befolgen Sie die Anweisungen des Herstellers. Sollte mit „mikrowellensicher“ gekennzeichnet sein. Manche Kunststoffbehälter werden weich, wenn die Lebensmittel darin heiß werden. „Kochbeutel“ und fest verschlossene Plastikbeutel sollten entsprechend den Anweisungen auf der Verpackung aufgeschlitzt, durchstochen oder belüftet werden.



Plastikfolie

Nur für die Mikrowelle geeignet. Zum Abdecken von Speisen während des Kochens, um die Feuchtigkeit zu bewahren. Achten Sie darauf, dass die Frischhaltefolie nicht mit den Lebensmitteln in Berührung kommt.



Thermometer

Nur mikrowellengeeignet (Fleisch- und Süßigkeitenthermometer).















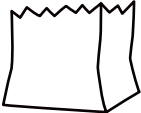

Wachspapier

Als Abdeckung verwenden, um Spritzer zu vermeiden und die Feuchtigkeit zu speichern.

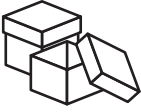

MATERIALIEN KÖNNEN NICHT IM MIKROWELLENHERD VERWENDET WERDEN

UTENSILIEN	BEMERKUNGEN	
 Aluminiumschale	Kann Lichtbögen verursachen. Die Speisen in eine mikrowellengeeignete Schüssel geben.	
 Lebensmittelkarton mit Metallgriff	Kann Lichtbögen verursachen. Die Speisen in eine mikrowellengeeignete Schüssel geben.	
 Utensilien aus Metall oder mit Metallbeschlägen	Metall schirmt die Lebensmittel vor der Mikrowellenenergie ab. Metallverkleidungen können Lichtbögen verursachen.	
 Metall-Drahtbinder	Dies kann zu Lichtbögen führen und einen Brand im Backofen verursachen.	
 Papiertüten	Kann einen Brand im Backofen verursachen.	
 Kunststoffschaum	Kunststoffschaum kann schmelzen oder die Flüssigkeit im Inneren verunreinigen, wenn er hohen Temperaturen ausgesetzt wird.	
 Holz	Holz trocknet bei der Verwendung im Mikrowellenherd aus und kann splintern oder reißen.	

PRODUKTEINSTELLUNG

AUFSTELLEN DES OFENS

NAMEN VON TEILEN UND ZUBEHÖR FÜR MIKROWELLENHERDE

Nehmen Sie den Backofen und alle Materialien aus dem Karton und dem Backraum.

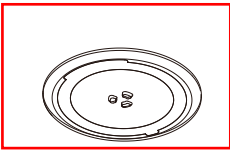

Glastablett

(Kann unter allen Funktionen verwendet werden)

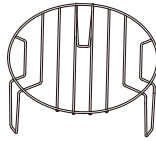

Grillrost (kann nicht für die Mikrowellenfunktion verwendet werden und muss auf die Glasschale gelegt werden)

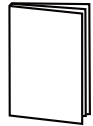

Bedienungsanleitung

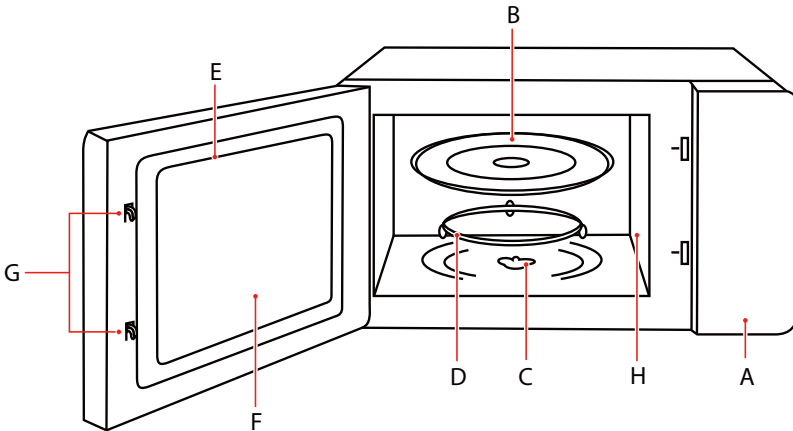

- | | |
|-----------------------------|-----------------------------------|
| A. Bedienfeld | E. Montage der Tür |
| B. Glastablett | F. Beobachtungsfenster |
| C. Drehscheibenwelle | G. Sicherheitsverriegelungssystem |
| D. Drehtellerring-Baugruppe | H. Abdeckung des Hohlleiters |



HINWEIS

Bei Abweichungen zwischen dem Gerät und den Abbildungen in dieser Anleitung hat das Produkt Vorrang.

AUFSTELLEN DES OFENS

DREHSCHIEBENANLAGE

Reinigung des Garraums und Einsetzen des Drehtellers.

Vergewissern Sie sich bei Neuinstallationen, dass alle Verpackungs- und Transportbänder von der Drehscheibenwelle entfernt wurden.

Bevor Sie das Gerät zum ersten Mal für die Zubereitung von Speisen verwenden, müssen Sie den Drehteller richtig anbringen. Sie müssen den Garraum und das Zubehör reinigen.

Wie man die Drehscheibe aufstellt:

1. Setzen Sie den Drehtellerring ein ③ in die Aussparung im Garraum.
 2. Setzen Sie das Glastablett ① auf die Drehtellerring-Baugruppen ③.
- Bringen Sie die erhabenen, geschwungenen Linien in der Mitte des Bodens der Glasschale zwischen den drei Speichen des Schafts an.
- Stellen Sie sicher, dass die Glasschale ① in der Drehtellerwelle einrastet ② in der Mitte des Garraums flügel. Die Rollen auf der Welle sollten in die untere Kante der Drehscheibe passen.

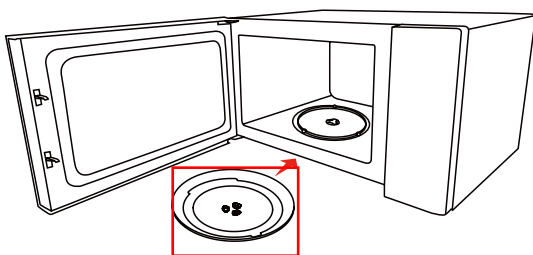
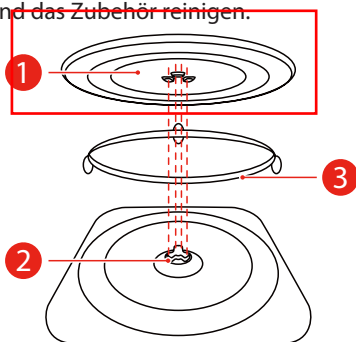

HINWEIS

- Verwenden Sie das Gerät niemals ohne den Drehteller. Vergewissern Sie sich, dass sie richtig eingerastet ist. Der Drehteller kann sich im oder gegen den Uhrzeigersinn drehen.
- Stellen Sie die Glasschale niemals auf den Kopf. Das Glastablett sollte niemals eingeeengt werden.
- Beim Garen müssen immer sowohl die Glasschale als auch der Drehteller eingesetzt werden.
- Alle Lebensmittel und Lebensmittelbehälter werden zum Garen immer auf das Glastablett gestellt.
- Schränken Sie niemals die Bewegung des Drehtellers ein.
- Wenn die Glasablage oder der Drehtellerring reißt oder bricht, wenden Sie sich an das nächste autorisierte Servicezentrum.

AUFSTELLEN DES OFENS

ARBEITSPLATTEMONTAGE

Entfernen Sie sämtliches Verpackungsmaterial und Zubehör. Untersuchen Sie den Backofen auf Schäden wie Beulen oder eine zerbrochene Tür. Nicht einbauen, wenn der Ofen beschädigt ist.

Kabinett: Entfernen Sie alle Schutzfolien, die sich auf der Oberfläche des Mikrowellengehäuses befinden. Entfernen Sie nicht die Wellenleiterabdeckung, die zum Schutz des Magnetrons am Ofenhohlraum angebracht ist.

INSTALLATION

1. Wählen Sie eine ebene Fläche, die genügend Freiraum für die Ansaug- und/oder Auslassöffnungen bietet.
 - a. Die minimale Installationshöhe beträgt 85 cm.
 - b. Die Rückseite des Geräts muss an einer Wand angebracht sein. Lassen Sie einen Mindestabstand von 30 cm über dem Ofen. Zwischen dem Ofen und den angrenzenden Wänden ist ein Mindestabstand von 20 cm erforderlich.
 - c. Entfernen Sie die Beine nicht vom Boden des Backofens.
 - d. Die Blockierung der Ansaug- und/oder Auslassöffnungen kann den Ofen beschädigen.
 - e. Stellen Sie den Ofen so weit wie möglich von Radios und Fernsehgeräten entfernt auf. Der Betrieb des Mikrowellenofens kann zu Störungen des Radio- oder Fernsehempfangs führen.

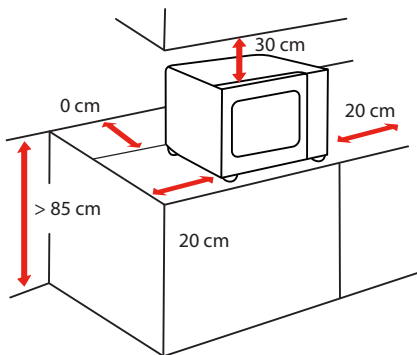

SEITE	ABSTAND CM
Oberseite	30 cm
Links	20 cm
Richtig	20 cm
Dahinter	0 cm
Vorn	Frei

AUFSTELLEN DES OFENS

2. Schließen Sie Ihren Backofen an eine normale Haushaltssteckdose an. Vergewissern Sie sich, dass die Spannung und die Frequenz mit der Spannung und der Frequenz auf dem Typenschild übereinstimmen.



- Stellen Sie den Backofen nicht über einem Herd oder einem anderen Wärme erzeugenden Gerät auf.
Wenn der Ofen in der Nähe oder über einer Wärmequelle installiert wird, kann er beschädigt werden und die Garantie erlischt.

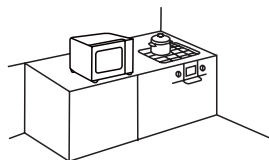

Die zugängliche Oberfläche kann während des Betriebs heiß sein.

GEBRAUCHSANWEISUNG

VOR DER ERSTEN BENUTZUNG

Das Gerät kann bei der ersten Benutzung unangenehme Gerüche erzeugen.

In diesem Abschnitt erfahren Sie, was Sie tun müssen, bevor Sie Ihre Mikrowelle zum ersten Mal zur Zubereitung von Speisen verwenden. Lesen Sie den Abschnitt mit dem Titel „**WICHTIGE SICHERHEITSHINWEISE**“ auf Seite 3 vor.

Bevor Sie Ihr neues Gerät in Betrieb nehmen können, müssen Sie den Plattenteller richtig anbringen. Sie müssen auch den Garraum und das Zubehör reinigen.



- Verwenden Sie das Gerät niemals ohne den Drehteller.
- Vergewissern Sie sich, dass er richtig eingerastet ist. Der Drehteller kann sich im oder gegen den Uhrzeigersinn drehen.

BETRIEB

BEDIENFELD UND FUNKTIONEN

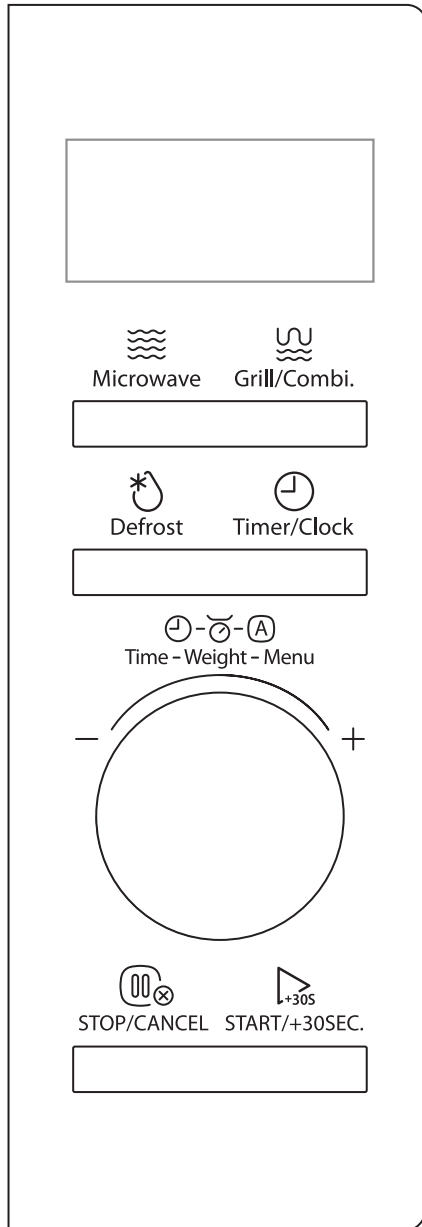

1. UHRZEIT EINSTELLEN

a Drücken Sie zweimal  Timer/Clock, „00:00“ wird angezeigt.



b Stellen Sie die Stunden mit dem Drehknopf ein.

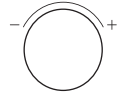

c Drücken Sie  Timer/Clock oder , um die Stundenzahlen zu bestätigen.

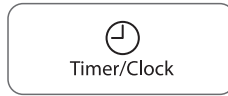

oder



d Stellen Sie die Minuten mit dem Drehknopf ein.

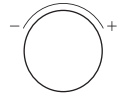

e Drücken Sie  Timer/Clock oder , um zu bestätigen. Die Uhrzeit ist eingestellt.



oder



HINWEIS

- Die Uhr ist eine 24-Stunden-Anzeige. Wenn die Uhr nicht eingestellt ist, funktioniert sie nicht, wenn die Mikrowelle eingeschaltet ist.
- Um die Uhr zurückzusetzen, wiederholen Sie bitte die Schritte a bis e.

2. EINSTELLEN DES KÜCHENTIMERS

- a**  Drücken Sie einmal Timer/Clock, „00:00“ wird angezeigt.



- b** Stellen Sie mit dem Drehknopf die gewünschte Zeit ein. Der maximale Zeitwert ist „95:00“.

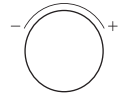

- c**  Drücken Sie START/+30SEC. zur Bestätigung. Der Timer beginnt herunterzuzählen.



- Der Kurzzeitwecker ist ein Timer.
- Bei aktiviertem Küchentimer kann kein anderes Programm eingestellt werden.

3. GAREN IM MIKROWELLENOFEN

Es gibt 5 Leistungsstufen.

STUFE	LEISTUNG	ANZEIGE
1	100 %	P100
2	80 %	P80
3	50 %	P50
4	30 %	P30
5	10 %	P10

- a** Drücken Sie wiederholt  Microwave, um die Leistungsstufe zu wählen.



- a** oder
Drücken Sie einmal  Microwave und stellen Sie dann die Leistungsstufe mit dem Drehknopf ein. 5 Leistungsstufen sind verfügbar.



- b** Drücken Sie  START/+30SEC., um die Leistungsstufe zu bestätigen.



- c** Stellen Sie mit dem Drehknopf die Garzeit ein. Der maximale Zeitwert ist „95:00“.

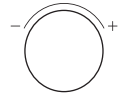

- d** Drücken Sie  START/+30SEC., um die Zubereitung zu starten.



4. GRILLEN

- a** Drücken Sie einmal  Grill/Combi., „G-1“ wird angezeigt.



- b** Drücken Sie  START/+30SEC., um den Modus zu bestätigen.



- c** Stellen Sie mit dem Drehknopf die Garzeit ein. Der maximale Zeitwert ist „95:00“.

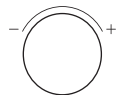

- d** Drücken Sie , um die Zubereitung zu starten.



• Der Summer ertönt, um Sie daran zu erinnern, die Lebensmittel während des Auftauens zu wenden.
Falls kein Vorgang stattfindet, setzt der Backofen den Betrieb fort.

5. KOMBINIERTES KOCHEN

- a** Drücken Sie wiederholt , um den gewünschten Zubereitungsmodus zu wählen. „C-1, C-2“ sind verfügbar.



- oder
Drücken Sie einmal , und stellen Sie dann den Zubereitungsmodus mit dem Drehknopf ein.



- b** Drücken Sie , um den Modus zu bestätigen.



- c** Stellen Sie mit dem Drehknopf die Garzeit ein. Der maximale Zeitwert ist „95:00“.

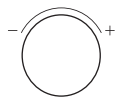

- d** Drücken Sie , um die Zubereitung zu starten.



KOMBINIERTE GARTABELLE

FUNKTION	ANZEIGE	MIKROWELLENLEISTUNG	GRILLLEISTUNG
Kombiniertes Garen 1	C-1	55 %	45 %
Kombiniertes Garen 2	C-2	36 %	64 %

6. AUFTAUEN NACH ZEIT

- a** Drücken Sie zweimal  Defrost , damit wird „dEF2“ angezeigt.



- b** Stellen Sie mit dem Drehknopf die gewünschte Auftauzeit ein. Der maximale Zeitwert ist „95:00“.

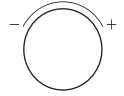

- c** Drücken Sie  START/+30SEC. , um das Auftauen zu starten.



- Der Summer ertönt, um Sie daran zu erinnern, die Lebensmittel während des Auftauens umzudrehen.
- Falls kein Vorgang stattfindet, setzt der Backofen den Betrieb fort.
- Die Auftauleistung beträgt P30 und kann nicht geändert werden.

7. AUFTAUEN NACH GEWICHT

- a** Drücken Sie einmal  Defrost , damit wird „dEF1“ angezeigt.



- b** Stellen Sie mit dem Drehknopf das Gewicht der Lebensmittel ein. Der Gewichtsbereich reicht von 100 g bis 2000 g.

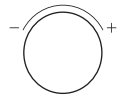

- c** Drücken Sie  START/+30SEC. , um das Auftauen zu starten.



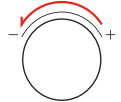

8. SCHNELLES KOCHEN

- a** Drehen Sie den Drehknopf nach links, um eine Garzeit bei 100 % Leistung einzustellen.

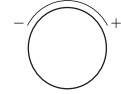

- b** Stellen Sie die Zubereitungszeit mit dem Drehknopf ein. Der maximale Zeitwert ist „95:00“.



- c** Drücken Sie  um die Zubereitung zu starten.



- a** Drücken Sie  um die Speisen 30 Sekunden auf 100 % Leistung zu garen. Mit jedem Druck auf dieselbe Taste verlängert sich die Zeit um 30 Sekunden. Die Höchstzeit beträgt „95:00“.



9. MEHRSTUFIGES GAREN

Beispiel: Speisen für 5 Minuten auftauen und dann für 7 Minuten mit 80 % Mikrowellenleistung garen.

- a** Drücken Sie zweimal  Defrost, „dEF2“ wird angezeigt.



- b** Stellen Sie mit dem Drehknopf die gewünschte Auftauzeit auf 5 Minuten ein.

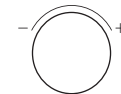

- c** Drücken Sie  Microwave wiederholt, bis „P80“ angezeigt wird.



- d** Drücken Sie  um die Leistungsstufe zu bestätigen.



- e Stellen Sie mit dem Drehknopf die Zubereitungszeit auf 7 Minuten ein.

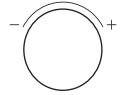

- f Drücken Sie  , um die Zubereitung zu starten.



HINWEIS

- Zum mehrstufigen Garen können zwei Garstufen eingestellt werden.
- Wenn Sie die Auftaufunktion einstellen, wird sie automatisch in der ersten Stufe ausgeführt.
- Kurzzeitwecker und Auto-Menü können nicht als eine von mehreren Stufen eingestellt werden.

10. AUTO-MENÜ

- a Drehen Sie im Standby-Modus den Drehknopf einmal nach rechts. Daraufhin wird „A-1“ angezeigt.

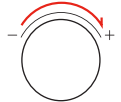

- b Drehen Sie den Drehknopf weiter, um das gewünschte Menü auszuwählen.
Es stehen 8 Auto-Menüs verfügbar.

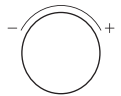

- c Drücken Sie  zur Bestätigung.



- d Stellen Sie mit dem Drehregler das Gewicht der Lebensmittel ein.

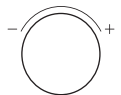

- e Drücken Sie  , um die Zubereitung zu starten.



AUTOMENÜ-TABELLE

MENÜ	GEWICHT/ MENGE	ANZEIGE	LEISTUNGSSTUFE
A-1 Automatisches Aufwärmen	200 g	200 g	P100
	400 g	400 g	
	600 g	600 g	
A-2 Gemüse	200 g	200 g	P100
	300 g	300 g	
	400 g	400 g	
A-3 Fisch	250 g	250 g	P80
	350 g	350 g	
	450 g	450 g	
A-4 Fleisch	250 g	250 g	P100
	350 g	350 g	
	450 g	450 g	
A-5 Pasta	50 g (mit 450 ml kaltem Wasser)	50 g	P80
	100 g (mit 800 ml kaltem Wasser)	100 g	
A-6 Kartoffeln	200 g	200 g	P100
	400 g	400 g	
	600 g	600 g	
A-7 Fertigpizza	200 g	200 g	P100/Grill
	400 g	400 g	
A-8 Suppe	200 ml	200	P80
	400 ml	400	

11. KINDERSICHERUNG

Sie können diese Funktion benutzen, um zu verhindern, dass Kinder den Backofen versehentlich einschalten.

- a** Kindersicherung aktivieren:
Halten Sie im Standby-Modus  für 3 Sekunden gedrückt.
Es ertönt ein Signalton und das Sperrsymbol wird angezeigt.



- b** Kindersicherung deaktivieren:
Berühren Und halten Sie  drei Sekunden lang gedrückt,
wenn das Gerät gesperrt ist.
Es ertönt ein Signalton.



12. ABFRAGEFUNKTION

- a** Wenn der Ofen gart, drücken Sie  Timer/Clock . Die aktuelle Uhrzeit wird für drei Sekunden auf dem Display angezeigt.



- b** Drücken Sie im Mikrowellenbetrieb  Microwave , um die Leistungsstufe abzufragen. Diese wird 3 Sekunden angezeigt.



- c** Drücken Sie im Betriebszustand Grillen und Kombiniertes Garen  Grill/Combi. , um den Garmodus abzufragen. Diese wird 3 Sekunden angezeigt.



REINIGUNG

Bei guter Pflege und Reinigung wird Ihr Gerät sein Aussehen behalten und lange Zeit voll funktionsfähig bleiben. Wir erklären Ihnen hier, wie Sie Ihr Gerät richtig pflegen und reinigen sollten.



WARNUNG

- Zerkratztes Glas in der Gerätetür kann sich zu einem Riss entwickeln. Verwenden Sie keinen Glasschaber, keine scharfen oder scheuernden Reinigungsmittel oder Reiniger.
- Die Oberfläche des Geräts kann beschädigt werden, wenn sie nicht richtig gereinigt wird. Mikrowellenenergie kann entweichen. Reinigen Sie das Gerät regelmäßig, und entfernen Sie Lebensmittelreste sofort.
- Tauchen Sie das Gerät nicht in Wasser ein und reinigen Sie es nicht unter einem Wasserstrahl.

Reinigungsmittel

Um sicherzustellen, dass die verschiedenen Oberflächen nicht durch die Verwendung eines falschen Reinigungsmittels beschädigt werden, beachten Sie die folgenden Hinweise. Waschen Sie neue Schwammtücher vor dem Gebrauch gründlich aus.

Nicht verwenden:



Harte oder scheuernde
Reinigungsmittel



Metall- oder Glasschaber
zum Reinigen der
Türverkleidungen



Metall- oder Glasschaber
zur Reinigung der
Türdichtung



Harte Scheuerschwämme
oder Schwämme



Reinigungsmittel mit
hohem Alkoholgehalt

GERÄTEFRONT

Heiße Seifenlauge:

Mit einem Geschirrtuch reinigen und anschließend mit einem weichen Tuch abtrocknen.

Verwenden Sie zur Reinigung keine Metall- oder Glasschaber.

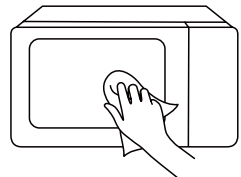

REINIGUNG

GERÄTEFRONTPLATTE

Heiße Seifenlauge:

Mit einem Geschirrtuch reinigen und anschließend mit einem weichen Tuch abtrocknen. Spritzer und Flecken von Kalk, Fett, Stärke und Eiweiß sofort entfernen. Unter diesen Flecken oder Spritzern kann sich Korrosion bilden. Verwenden Sie zur Reinigung keine Glasreiniger, Metall- oder Glasschaber.

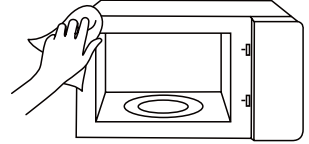

GERÄTEHOHLRAUM

Heiße Seifenlauge oder Essiglösung:

Mit einem Geschirrtuch reinigen und anschließend mit einem weichen Tuch abtrocknen. Verwenden Sie kein Backofenspray oder andere aggressive Backofenreiniger oder Scheuermittel. Scheuerschwämme, raue Schwämme und Pfannenreiniger sind ebenfalls ungeeignet. Diese Punkte kratzen nur an der Oberfläche. Lassen Sie die Innenflächen vollständig trocknen.

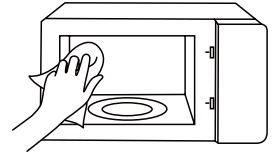

AUSSPARUNG IM GARRAUM

Feuchtes Tuch:

Es darf kein Wasser durch den Drehtellerantrieb in das Gerät laufen. Trocknen Sie den Plattentellerantrieb mit einem Tuch ab.

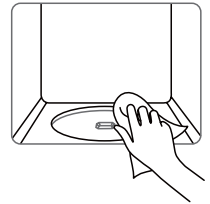

DREHTELLER UND ROLLENRING

Heiße Seifenlauge:

Wenn Sie den Plattenteller wieder in seine Aussparung einsetzen, muss er richtig einrasten.

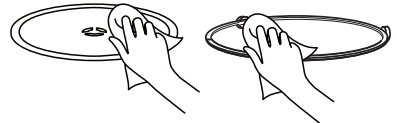

TÜRFELDER

Glasreiniger:

Mit einem Geschirrtuch reinigen. Verwenden Sie keine Glasschaber.

FEHLERSUCHE

Prüfen Sie Ihr Problem anhand der nachstehenden Tabelle und probieren Sie die Lösungen für jedes Problem aus. Wenn der Mikrowellenherd immer noch nicht richtig funktioniert, wenden Sie sich an das nächste autorisierte Service-Center.

PROBLEM	MÖGLICHE URSACHE	MÖGLICHE LÖSUNG
Backofen lässt sich nicht starten	<ul style="list-style-type: none"> a. Das Stromkabel für den Ofen ist nicht eingesteckt. b. Die Tür ist offen. c. Falsche Bedienung ist eingestellt. 	<ul style="list-style-type: none"> a. Stecken Sie den Stecker in die Steckdose. b. Schließen Sie die Tür und versuchen Sie es erneut. c. Anweisungen prüfen
Lichtbogenbildung oder Funkenbildung	<ul style="list-style-type: none"> a. Es wurden Materialien verwendet, die im Mikrowellenherd vermieden werden sollten. b. Der Backofen wird im leeren Zustand betrieben. c. Verschüttete Lebensmittel bleiben in der Höhle zurück. 	<ul style="list-style-type: none"> a. Verwenden Sie nur mikrowellene geeignetes Kochgeschirr. b. Nicht bei leerem Backofen betreiben. c. Hohlraum mit einem weichen, feuchten Tuch reinigen.
Ungleichmäßig gekochte Lebensmittel	<ul style="list-style-type: none"> a. Es wurden Materialien verwendet, die im Mikrowellenherd vermieden werden sollten. b. Die Lebensmittel sind nicht vollständig aufgetaut. c. Garzeit, Leistungsstufe ist nicht geeignet. d. Die Speisen werden nicht gewendet oder umgerührt. 	<ul style="list-style-type: none"> a. Verwenden Sie nur mikrowellene geeignetes Kochgeschirr. b. Lebensmittel vollständig auftauen. c. Verwenden Sie die richtige Garzeit und Leistungsstufe. d. Speisen wenden oder umrühren.
Überkochte Lebensmittel	Garzeit, Leistungsstufe ist nicht angemessen.	Verwenden Sie die richtige Garzeit und Leistungsstufe.
Ungekochte Lebensmittel	<ul style="list-style-type: none"> a. Es wurden Materialien verwendet, die im Mikrowellenherd vermieden werden sollten. b. Die Lebensmittel sind nicht vollständig aufgetaut. c. Die Belüftungsöffnungen des Ofens sind eingeschränkt. d. Garzeit, Leistungsstufe ist nicht geeignet. 	<ul style="list-style-type: none"> a. Verwenden Sie nur mikrowellene geeignetes Kochgeschirr. b. Lebensmittel vollständig auftauen. c. Überprüfen Sie, ob die Lüftungsöffnungen des Ofens nicht verschlossen sind. d. Richtige Garzeit und Leistungsstufe verwenden
Unsachgemäßes Abtauen	<ul style="list-style-type: none"> a. Es wurden Materialien verwendet, die im Mikrowellenherd vermieden werden sollten. b. Garzeit, Leistungsstufe ist nicht geeignet. c. Die Speisen werden nicht gewendet oder umgerührt. 	<ul style="list-style-type: none"> a. Verwenden Sie nur mikrowellene geeignetes Kochgeschirr. b. Verwenden Sie die richtige Garzeit und Leistungsstufe. c. Lebensmittel wenden oder umrühren.



Gemäß der Richtlinie über Elektro- und Elektronik-Altgeräte (WEEE) müssen Elektro- und Elektronik-Altgeräte getrennt gesammelt und verarbeitet werden. Sollten Sie dieses Produkt zu irgendeinem Zeitpunkt in der Zukunft entsorgen müssen, entsorgen Sie es bitte NICHT mit dem Hausmüll. Bitte geben Sie dieses Produkt an WEEE-Sammelstellen ab, sofern vorhanden.

#DetailsMatter

MANUALE DI ISTRUZIONI

FORNO A MICROONDE

MW3-AG20PE(BK) / MW3-AG20PE(WH)

Consultare questo manuale di istruzioni prima di utilizzare il prodotto.

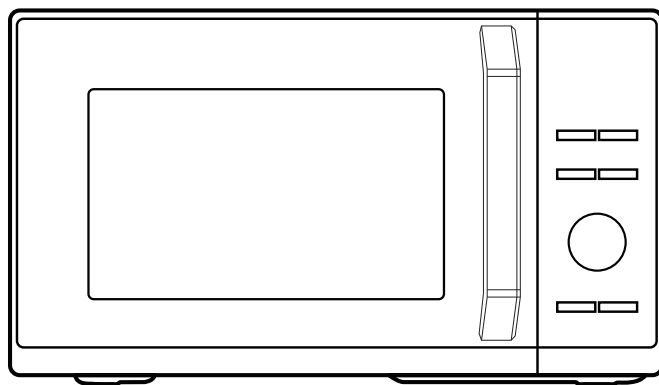

TOSHIBA

INDICE

SICUREZZA DEL PRODOTTO

Precauzioni per evitare la possibile esposizione a un'eccessiva energia a microonde.....	IT-01
Importanti istruzioni di sicurezza	IT-03
Riduzione del rischio di lesioni alle persone mediante messa a terra.....	IT-08
Pulizia.....	IT-10
Utensili	IT-11
Materiali che si possono usare nel forno a microonde.....	IT-12
Materiali che non si possono usare nel forno a microonde.....	IT-14

IMPOSTAZIONI DEL PRODOTTO

Preparazione del forno.....	IT-15
-----------------------------	-------

ISTRUZIONI PER L'USO

Prima di utilizzare per la prima volta.....	IT-19
Funzionamento	IT-20
1. Impostazione dell'orologio	IT-21
2. Impostazione del timer di cottura	IT-22
3. Cottura al microonde	IT-22
4. Cottura alla griglia	IT-23
5. Cottura combinata	IT-24
6. Scongellamento in base al tempo	IT-25
7. Scongellamento in base al peso	IT-25
8. Cottura veloce	IT-26

9. Cottura in più fasi	IT-26
10. Menu automatico	IT-27
11. Funzione di blocco per bambini	IT-29
12. Funzione di richiesta	IT-29
Pulizia	IT-30

MANUTENZIONE

Risoluzione dei problemi	IT-32
--------------------------------	-------



NOTA

PRIMA DI UTILIZZARE QUESTO PRODOTTO, LEGGERE, COMPRENDERE E SEGUIRE QUESTE ISTRUZIONI. ASSICURARSI DI CONSERVARE QUESTO LIBRETTO PER RIFERIMENTI FUTURI.

SICUREZZA DEL PRODOTTO

PRECAUZIONI PER EVITARE LA POSSIBILE ESPOSIZIONE A UN'ECESSIVA ENERGIA A MICROONDE

(a). Non tentare di far funzionare questo forno con lo sportello aperto, poiché ciò può comportare un'esposizione dannosa all'energia delle microonde. È importante non rompere o manomettere gli interblocchi di sicurezza.

(b). Non posizionare alcun oggetto tra la parte anteriore del forno e lo sportello e non lasciare che lo sporco o i residui di detergente si accumulino sulle superfici di tenuta.

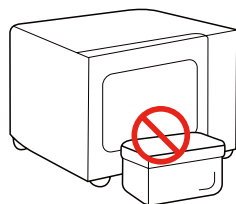

(c). **AVVERTENZA:** Se lo sportello o le guarnizioni dello sportello sono danneggiati, il forno non deve essere messo in funzione fino a quando non sia stato riparato da una persona competente.

ADDENDUM

Se l'apparecchio non è sottoposto a una buona pulizia, la sua superficie potrebbe essere deteriorata e compromettere la durata di vita dell'apparecchio e portare a una situazione pericolosa.

SPECIFICHE

MODELLO	MW3-AG20PE(BK) / MW3-AG20PE(WH)
TENSIONE NOMINALE / FREQUENZA	230V~ 50Hz
INGRESSO NOMINALE (MICROONDE)	1270 W
POTENZA NOMINALE (MICROONDE)	800 W
INGRESSO NOMINALE (GRILL)	1000 W

CONSUMO ENERGETICO

Informazioni sul prodotto relative al consumo energetico e al tempo massimo per raggiungere la modalità di basso consumo applicabile.

Modalità standby	0.8 W
------------------	-------

Il tempo massimo necessario al forno a microonde per raggiungere automaticamente la modalità o la condizione di basso consumo applicabile.	20 minuti
--	-----------



NOTA

Tutte le immagini in questo manuale sono solo a scopo illustrativo; questi potrebbero essere leggermente diversi dall'attrezzatura acquistata, fare riferimento al prodotto reale.

IMPORTANTI ISTRUZIONI DI SICUREZZA



AVVERTENZA

Per ridurre il rischio di incendio, scosse elettriche, lesioni alle persone o esposizione a un'eccessiva energia del forno a microonde quando si usa l'apparecchio, seguire le precauzioni di base, tra cui le seguenti:



Leggere e seguire la specifica: "**PRECAUZIONI PER EVITARE POSSIBILI ESPOSIZIONI A ENERGIA A MICROONDE ECCESSIVA**".



Questo apparecchio può essere utilizzato da bambini a partire da 8 anni e da persone con ridotte capacità fisiche, sensoriali o mentali o con mancanza di esperienza e conoscenza, a condizione che vengano supervisionati o istruiti sull'uso dell'apparecchio in modo sicuro e che comprendano i pericoli connessi. I bambini non devono giocare con l'apparecchio.

La pulizia e la manutenzione da parte dell'utente non devono essere effettuate da bambini senza supervisione.



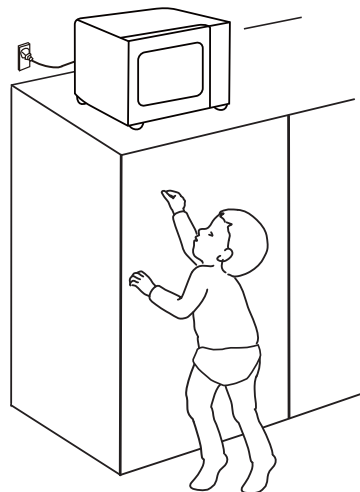

Tenere l'apparecchio e il suo cavo fuori dalla portata dei bambini di età inferiore agli 8 anni.





IMPORTANTI ISTRUZIONI DI SICUREZZA

 Se il cavo di alimentazione è danneggiato, deve essere sostituito dal produttore, dal suo agente di assistenza o da persone analogamente qualificate, al fine di evitare qualsiasi pericolo.

 **AVVERTENZA:** Assicurarsi che l'apparecchio sia spento prima di sostituire la lampadina per evitare la possibilità di scosse elettriche.

 **AVVERTENZA:** È pericoloso per chiunque non sia una persona competente eseguire qualsiasi operazione di manutenzione o riparazione che comporti la rimozione di una copertura che protegga dall'esposizione alle microonde.

 **AVVERTENZA:** I liquidi e gli altri alimenti non devono essere riscaldati in contenitori sigillati perché possono esplodere.

 Quando si riscaldano alimenti in contenitori di plastica o di carta, controllare il forno a causa della possibilità di accensione.

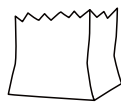



 Usare solo utensili adatti all'uso nel forno a microonde.

 In caso di emissione di fumo, spegnere o scollegare l'apparecchio e tenere lo sportello chiuso per soffocare eventuali fiamme.

 Il riscaldamento a microonde delle bevande può provocare un'ebollizione eruttiva ritardata, pertanto occorre prestare attenzione quando si maneggia il contenitore.

IMPORTANTI ISTRUZIONI DI SICUREZZA

 Mescolare o agitare il contenuto dei biberon e dei vasetti per alimenti per bambini e controllare la temperatura prima del consumo, al fine di evitare ustioni.

 È importante pulire regolarmente il forno ed eliminare eventuali residui di cibo. Vi ringraziamo per aver mantenuto in ordine l'area della guida d'onda. Se ci sono residui di cibo sull'area della guida d'onda o sulla cavità, pulirli con un panno morbido e umido. La mancata rimozione dei residui di cibo può provocare scintille innocue, una piccola quantità di fumo e/o lo scolorimento della cavità del microonde.

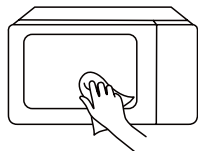



 Il mancato mantenimento del forno in condizioni di pulizia potrebbe portare a un deterioramento della superficie che potrebbe influire negativamente sulla durata dell'apparecchio e causare eventualmente una situazione di pericolo.

 Utilizzare solo la sonda di temperatura raccomandata per questo forno (per i forni dotati della possibilità di utilizzare una sonda di rilevamento della temperatura).

 Il forno a microonde deve essere azionato con lo sportello decorativo aperto (per i forni con sportello decorativo).

IMPORTANTI ISTRUZIONI DI SICUREZZA

-  Questo apparecchio è destinato a essere utilizzato in applicazioni domestiche e simili come:
1. aree di cucina del personale in negozi, uffici e altri ambienti di lavoro;
 2. dai clienti in alberghi, motel e altri ambienti di tipo residenziale;
 3. fattorie;
 4. ambienti di tipo bed and breakfast.
-

 Il forno a microonde è destinato al riscaldamento di cibi e bevande. L'essiccazione di cibo o l'asciugatura di indumenti e il riscaldamento di cuscini riscaldanti, pantofole, spugne, panni umidi e simili possono comportare il rischio di lesioni, accensione o incendio.

 L'apparecchio è destinato a essere usato in modo indipendente.

 La superficie posteriore dell'apparecchio deve essere collocata contro una parete.

 La temperatura delle superfici accessibili può essere elevata quando l'apparecchio è in funzione.

 **AVVERTENZA:** Quando l'apparecchio funziona in modalità combinata, i bambini dovrebbero usare il forno solo sotto la supervisione di un adulto a causa delle temperature generate.

IMPORTANTI ISTRUZIONI DI SICUREZZA

- ❌ Le uova nel loro guscio e le uova sode intere non devono essere riscaldate nel forno a microonde perché possono esplodere, anche dopo la fine del riscaldamento a microonde.

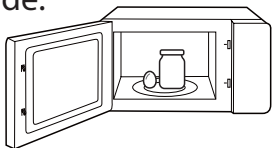

- ❌ L'apparecchio non deve essere installato dietro uno sportello decorativo per evitare il surriscaldamento. (Questo non è applicabile agli apparecchi con sportello decorativo).

- ❌ Gli apparecchi non sono destinati a essere azionati per mezzo di un timer esterno o un sistema di controllo a distanza separato.

- ❌ I contenitori metallici per alimenti e bevande non sono ammessi durante la cottura a microonde.

- ❌ L'apparecchio non deve essere pulito con un apparecchio a vapore.

**LEGGERE ATTENTAMENTE E
CONSERVARE PER RIFERIMENTO
FUTURO**

RIDUZIONE DEL RISCHIO DI LESIONI ALLE PERSONE MEDIANTE MESSA A TERRA

Questo apparecchio deve essere messo a terra. In caso di cortocircuito elettrico, la messa a terra riduce il rischio di scosse elettriche fornendo un filo di sicurezza per la corrente elettrica. Questo apparecchio è dotato di un cavo con un filo di messa a terra dotato di una spina di messa a terra. La spina deve essere inserita in una presa correttamente installata e messa a terra.

ATTENZIONE - L'uso improprio della messa a terra può comportare il rischio di scosse elettriche. Consultare un elettricista qualificato o un manutentore se le istruzioni di messa a terra non sono completamente comprese o se esistono dubbi sulla corretta messa a terra dell'apparecchio.

Se è necessario utilizzare una prolunga (utilizzare solo una prolunga a 3 fili).



PERICOLO

Rischio di scossa elettrica:

Toccare alcuni dei componenti interni può causare gravi lesioni personali o la morte. Non smontare questo apparecchio.

RIDUZIONE DEL RISCHIO DI LESIONI ALLE PERSONE MEDIANTE MESSA A TERRA



AVVERTENZA

Rischio di scossa elettrica:

L'uso improprio della messa a terra può provocare scosse elettriche. Non inserire la spina in una presa di corrente fino a quando l'apparecchio non è correttamente installato e messo a terra.

1. Viene fornito un cavo di alimentazione corto per ridurre i rischi derivanti dall'impigliarsi o dall'inciampare in un cavo più lungo.
2. Se viene usato un cavo lungo o una prolunga:
 - (1). La potenza elettrica indicata sul set di cavi o sulla prolunga deve essere almeno pari alla potenza elettrica dell'apparecchio.
 - (2). La prolunga deve essere del tipo a 3 fili con messa a terra.
 - (3). Il cavo più lungo deve essere disposto in modo da non essere appoggiato sul piano di lavoro o sul tavolo, dove può essere tirato dai bambini o dove si può inciampare involontariamente.

PULIZIA

Assicurarsi di scollegare l'apparecchio dalla rete elettrica.

1. Pulire la cavità del forno dopo l'uso con un panno leggermente umido.
2. Pulire gli accessori nel modo abituale con acqua e sapone.
3. Il telaio e la guarnizione dello sportello e le parti adiacenti devono essere puliti accuratamente con un panno umido quando sono sporchi.
4. Non usare detergenti abrasivi duri o raschietti metallici affilati per pulire il vetro dello sportello del forno, poiché possono graffiare la superficie, con il rischio di rottura del vetro.
5. Consiglio per la pulizia---Per una pulizia più facile delle pareti della cavità a contatto con il cibo cotto: mettere mezzo limone in una ciotola, aggiungere 300 ml (1/2 pinta) di acqua e riscaldare al 100% di potenza del microonde per 10 minuti. Pulire il forno con un panno morbido e asciutto).

UTENSILI



ATTENZIONE

Rischio di lesioni personali:

È pericoloso per chiunque non sia una persona competente eseguire qualsiasi operazione di manutenzione o riparazione che comporti la rimozione di una copertura che protegga dall'esposizione alle microonde.

Vedere le istruzioni su "**Materiali che si possono usare nel forno a microonde**" o "**Materiali che non si possono usare nel forno a microonde**".

Ci possono essere alcuni utensili non metallici che non sono sicuri da usare per il microonde. In caso di dubbio, è possibile testare l'utensile in questione seguendo la procedura riportata di seguito.

Test dell'utensile:

1. Riempire un contenitore per microonde con 1 tazza di acqua fredda (250 ml) insieme all'utensile in questione.
2. Cuocere alla massima potenza per 1 minuto.
3. Toccare attentamente l'utensile. Se l'utensile vuoto è caldo, non usarlo per la cottura a microonde.
4. Non superare il tempo di cottura di 1 minuto.

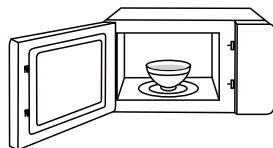





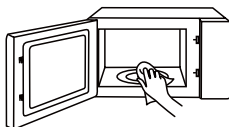











NOTA

MANTENERE PULITE LA CAVITÀ
E L'AREA DELLA GUIDA D'ONDA



MATERIALI CHE SI POSSONO USARE NEL FORNO A MICROONDE

UTENSILI	OSSERVAZIONI	
 Piatto per rosolatura	Seguire le istruzioni del produttore. Il fondo del piatto per rosolatura deve essere almeno 3/16 pollici (5 mm) al di sopra del piatto girevole. Un uso scorretto può causare la rottura del piatto girevole.	
 Stoviglie	Adatto solo al microonde. Seguire le istruzioni del produttore. Non utilizzare piatti crepati o scheggiati.	
 Vasetti di vetro	Rimuovere sempre il coperchio. Usare solo per riscaldare il cibo fino a quando è appena tiepido. La maggior parte dei vasetti di vetro non è resistente al calore e può rompersi.	
 Oggetti di vetro	Solo oggetti di vetro per forno resistenti al calore. Assicurarsi che non ci siano finiture metalliche. Non usare stoviglie crepate o scheggiate.	
 Sacchetti per la cottura in forno	Seguire le istruzioni del produttore. Non chiudere con fascette di metallo. Fare delle fessure per permettere la fuoriuscita del vapore.	
 Piatti e bicchieri di carta	Usare solo per cotture/riscaldamenti di breve durata. Non lasciare il forno incustodito durante la cottura.	
 Tovaglioli di carta	Usare per coprire il cibo per il riscaldamento e l'assorbimento dei grassi. Usare sotto supervisione solo per una cottura a breve termine.	
 Carta da forno	Da usare come copertura per evitare schizzi o come involucro per la cottura a vapore.	

MATERIALI CHE SI POSSONO USARE NEL FORNO A MICROONDE

UTENSILI

OSSERVAZIONI



Plastica

Adatto solo al microonde. Seguire le istruzioni del produttore. Dovrebbe avere l'etichetta "Adatto alle microonde". Alcuni contenitori di plastica si attorcigliano quando il cibo all'interno si scalda. I "sacchetti per l'ebollizione" e i sacchetti di plastica ben chiusi devono essere tagliati, forati o sfiatati come indicato dalla confezione.



Pellicola di plastica

Adatto solo al microonde. Usare per coprire il cibo durante la cottura per trattenere l'umidità. Non permettere che la pellicola di plastica tocchi il cibo.

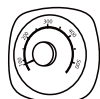

Termometri

Solo per microonde (termometri per carne e dolci).











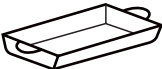





Carta cerata

Usare come copertura per evitare schizzi e trattenere l'umidità.



MATERIALI CHE NON SI POSSONO USARE NEL FORNO A MICROONDE

UTENSILI	OSSERVAZIONI
 Teglia in alluminio	Può causare archi elettrici. Trasferire il cibo in un piatto adatto alle microonde. 
 Cartone per alimenti con manico in metallo	Può causare archi elettrici. Trasferire il cibo in un piatto adatto alle microonde. 
 Utensili in metallo o con rifiniture in metallo	Il metallo protegge il cibo dall'energia delle microonde. Le finiture in metallo possono causare archi elettrici. 
 Fascette in metallo	Può causare archi elettrici e potrebbe causare un incendio nel forno. 
 Sacchetti di carta	Può causare un incendio nel forno. 
 Polistirolo	Il polistirolo può fondere o contaminare il liquido all'interno se esposto ad alta temperatura. 
 Legno	Il legno si asciuga se usato nel forno a microonde e può spaccarsi o rompersi. 

IMPOSTAZIONI DEL PRODOTTO

PREPARAZIONE DEL FORNO

NOME DELLE PARTI E DEGLI ACCESSORI DEL FORNO

Rimuovere il forno e tutti i materiali dalla confezione di cartone e dalla cavità del forno. Il forno è dotato dei seguenti accessori:

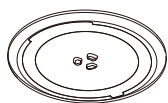

Vassoio di vetro

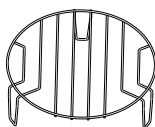

Cestello Griglia



Manuale di istruzioni

(Non può essere utilizzato con la funzione microonde e va collocato sul vassoio di vetro)

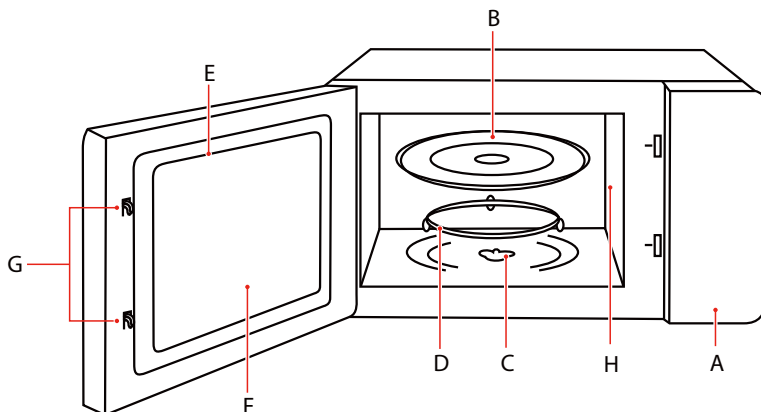

- | | |
|-----------------------------------|-----------------------------------|
| A. Pannello di controllo | E. Sportello |
| B. Vassoio di vetro | F. Finestra di ispezione |
| C. Albero piattaforma girevole | G. Sistema di blocco di sicurezza |
| D. Complesso piattaforma girevole | H. Coperchio della guida d'onda |



In caso di divergenze tra l'apparecchio e le immagini nel presente manuale, farà fede il prodotto effettivo.

PREPARAZIONE DEL FORNO

INSTALLAZIONE DELLA PIASTRA GIREVOLE

Pulizia del vano di cottura e posizionamento della piastra girevole

Per la prima installazione, assicurarsi che tutto l'imballaggio e il nastro da imballaggio siano stati rimossi dall'albero della piastra girevole.

Prima del primo utilizzo dell'apparecchio per la preparazione del cibo, si prega di installare la piastra girevole in maniera corretta. Si deve pulire il vano di cottura e gli accessori.

Come mettere la piastra girevole in posizione:

1. Inserire l'anello della piastra girevole ③ nell'incavo nel vano di cottura.
2. Posizionare il vassoio in vetro ① sull'anello della piastra girevole ③.

Montare le linee curve e rialzate al centro del fondo del vassoio di vetro tra i tre raggi dell'albero. Assicurarsi che il vassoio in vetro ① si innesti nell'albero della piastra girevole ② al centro della superficie del vano di cottura. I rulli sull'albero devono essere inseriti all'interno della dorsale inferiore della piastra girevole.

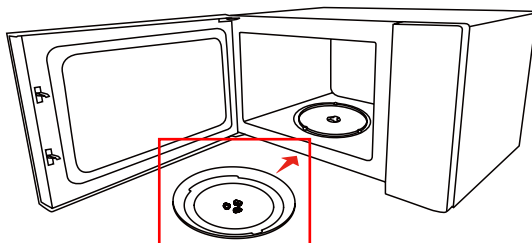
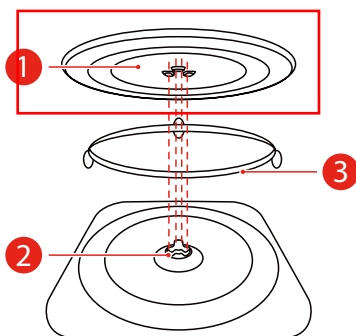

- Non utilizzare mai l'apparecchio senza la piastra girevole. Assicurarsi che sia correttamente inserita. La piastra girevole può girare in senso orario o antiorario.
- Non capovolgere mai il vassoio di vetro. Il movimento del vassoio in vetro non deve mai essere limitato.
- Durante la cottura devono essere sempre utilizzati sia il vassoio in vetro che il gruppo dell'anello della piastra girevole.
- Tutti gli alimenti e i loro contenitori devono sempre posizionati sul vassoio in vetro per la cottura.
- Non limitare mai il movimento della piastra girevole.
- Se il vassoio di vetro o il gruppo dell'anello della piastra girevole si incrina o si rompe, contattare il centro di assistenza autorizzato più vicino.

PREPARAZIONE DEL FORNO

INSTALLAZIONE SUL PIANO DI LAVORO

Rimuovere tutti i materiali di imballaggio e gli accessori.

Verificare che il forno non presenti rotture della porta o altri danni. Non installare il forno se è danneggiato.

Quadro: Rimuovere l'eventuale pellicola protettiva presente sulla superficie del quadro del forno a microonde. Non rimuovere il coperchio marrone chiaro della guida d'onda fissato alla cavità del forno per proteggere il magnetron.

INSTALLAZIONE

1. Scegliere una superficie piana che disponga di spazio libero sufficiente per le aperture di aspirazione e scarico.
 - a. L'altezza minima di installazione è di 85 cm.
 - b. La superficie posteriore degli apparecchi deve essere appoggiata a una parete. Lasciare uno spazio minimo di 30 cm sopra il forno e uno spazio di almeno 20 cm tra il forno e le pareti adiacenti.
 - c. Non rimuovere le gambe dalla parte inferiore del forno.
 - d. L'ostruzione delle aperture di aspirazione e scarico potrebbe danneggiare il forno.
 - e. Collocare il forno alla massima distanza possibile da radio e televisioni. L'utilizzo del forno a microonde può causare interferenze alla ricezione di radio e televisione.

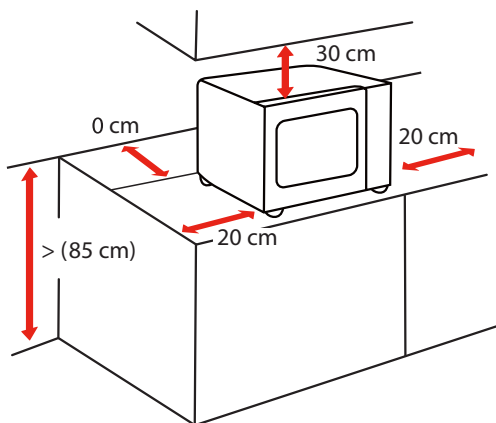

LATO	DISTANZA CM
Parte superiore	30 cm
Sinistra	20 cm
Destra	20 cm
Dietro	0 cm
Anteriore	Aperto



REMARQUE

En cas de différences entre l'appareil et les images dans ce manuel, l'appareil prévaut.

PREPARAZIONE DEL FORNO

2. Collegare il forno a una presa domestica standard. Verificare che tensione e frequenza dell'elettricità domestica siano uguali a quelle nominali indicate sull'etichetta dell'elettrodomestico.



AVVERTENZA

- Non installare il forno su un piano di cottura o su altri elettrodomestici che producono calore. Se il forno venisse installato in prossimità di una fonte di calore, potrebbe danneggiarsi e la garanzia non sarebbe più valida.

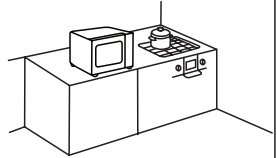

La superficie di accesso potrebbe surriscaldarsi durante il funzionamento.

ISTRUZIONI PER L'USO

PRIMA DI UTILIZZARE PER LA PRIMA VOLTA

L'apparecchio può produrre odori sgradevoli al primo utilizzo.

Questa sezione fornisce le istruzioni da seguire prima del primo utilizzo del microonde per preparare il cibo. Leggere prima la sezione intitolata **"IMPORTANTI ISTRUZIONI DI SICUREZZA"** a pagina 3.

Prima di utilizzare il nuovo apparecchio, si prega di posizionare correttamente la piastra girevole. È inoltre necessario pulire il vano di cottura e gli accessori.



NOTA

- Non utilizzare mai l'apparecchio senza la piastra girevole.
- Assicurarsi che sia correttamente inserita. La piastra girevole può ruotare in senso orario o antiorario.

FUNZIONAMENTO

PANNELLO DI CONTROLLO E FUNZIONI

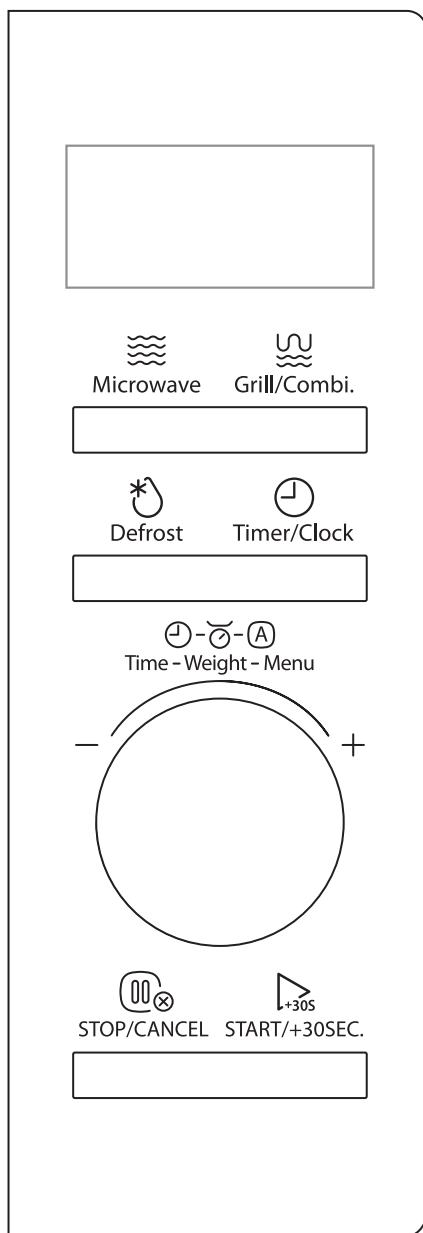

1. IMPOSTAZIONE DELL'OROLOGIO

- a** Premere due volte  Timer/Clock, sul display viene visualizzato "00:00".



- b** Ruotare la manopola per impostare le cifre delle ore.

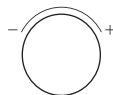

- c** Premere  Timer/Clock o  START/+30SEC. per confermare le cifre dell'ora.



- d** Ruotare la manopola per impostare le cifre dei minuti.

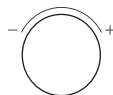

- e** Premere  Timer/Clock o  START/+30SEC. per confermare. L'orologio è stato impostato.



NOTA

- L'orologio viene visualizzato con il formato a 24 ore. Se l'orologio non è impostato, non funzionerà dopo l'accensione.
- Per resettare l'orologio, ripetere dal passaggio a al passaggio e.

2. IMPOSTAZIONE DEL TIMER DI COTTURA

a Premere una volta  Timer/Clock, "00:00" verrà visualizzato.



b Ruotare la manopola per impostare il tempo desiderato. Il massimo valore ammesso è "95:00".

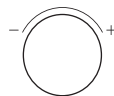

c Premere  START/+30SEC. per confermare. Il timer inizia il conto alla rovescia.



NOTA

- Il Timer di cottura è un conto alla rovescia.
- Non è possibile impostare altri programmi durante il timer di cottura.

3. COTTURA AL MICROONDE

Sono disponibili 5 livelli di potenza.

LIVELLO	POTENZA	DISPLAY
1	100%	P100
2	80%	P80
3	50%	P50
4	30%	P30
5	10%	P10

 Premere **Microwave** ripetutamente per scegliere il livello di potenza.

a **o**

Premere una volta , e ruotare la manopola per impostare il livello di potenza.

Sono disponibili 5 livelli di potenza.



b Premere  **START/+30SEC.** per confermare il livello di potenza.



c Ruotare la manopola per impostare il tempo di cottura, il valore di tempo massimo è "95:00".

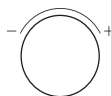

d Premere  **START/+30SEC.** per avviare la cottura.



4. COTTURA ALLA GRIGLIA

a Premere una volta,  **Grill/Combi.** "G- 1" verrà visualizzato.



b Premere  **START/+30SEC.** per confermare la modalità.



c Ruotare la manopola per impostare il tempo di cottura, il valore di tempo massimo è "95:00".

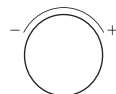

d Premere  START/+30SEC. per avviare la cottura.

 START/+30SEC.



• Il cicalino suonerà per ricordare di girare gli alimenti durante la cottura.
Se non si eseguono operazioni, il forno continua a funzionare.

5. COTTURA COMBINATA

a Premere  Grill/Combi. ripetutamente per scegliere la modalità di cottura voluta. "C-1, C-2" sono disponibili.

 Grill/Combi.

a Premere una volta , quindi ruotare la manopola per scegliere la modalità di cottura.

 Grill/Combi.



b Premere  START/+30SEC. per confermare la modalità.

 START/+30SEC.

c Ruotare la manopola per impostare il tempo di cottura, il valore di tempo massimo è "95:00".



d Premere  START/+30SEC. per avviare la cottura.

 START/+30SEC.

TABELLA DI COTTURA COMBINATA

FUNZIONI	DISPLAY	POTENZA DEL MICROONDE	POTENZA GRIGLIA
Combi. 1	C-1	55%	45%
Combi. 2	C-2	36%	64%

6. SCONGELAMENTO IN BASE AL TEMPO

a Premere due volte  Defrost e poi verrà visualizzato "dEF2".



b Ruotare la manopola per impostare il tempo di scongelamento desiderato, il valore di tempo massimo è "95:00".

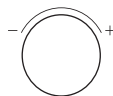

c Premere  START/+30SEC. per avviare lo scongelamento.



NOTA

- Il cicalino suonerà per ricordare di girare gli alimenti durante lo scongelamento. Se non si eseguono operazioni, il forno continua a funzionare.
- La potenza di scongelamento è P30 e non può essere modificata.

7. SCONGELAMENTO IN BASE AL PESO

a Premere una volta  Defrost e poi "dEF1" verrà visualizzato sul display.



b Ruotare la manopola per impostare il peso degli alimenti, la gamma di peso va da 100 g. a 2000 g.

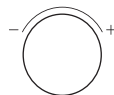

c Premere  START/+30SEC. per avviare lo scongelamento.



8. COTTURA VELOCE

a Ruotare la manopola verso sinistra per impostare il tempo di cottura al 100% della potenza.

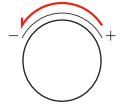

b Continuare a ruotare la manopola per regolare il tempo di cottura, il valore di tempo massimo è "95:00".

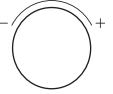

c Premere  per avviare la cottura.



a Premere  per cuocere gli alimenti al 100% della potenza per 30 secondi. Ogni pressione dello stesso tasto può aumentare di 30 secondi e il valore massimo di tempo è di "95:00".



9. COTTURA IN PIÙ FASI

Esempio: Scongelare gli alimenti per 5 minuti e poi cuocere al microonde all'80% di potenza per 7 minuti.

a Premere due volte  "Defrost", sul display viene visualizzato "dEF2".



b Ruotare la manopola per impostare il tempo di scongelamento desiderato a 5 minuti.

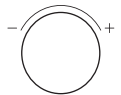

c Premere  Microwave ripetutamente fino a visualizzare "P80".



d Premere  per confermare il livello di potenza.



e Ruotare la manopola per impostare il tempo di cottura a 7 minuti.

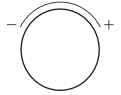

f Premere  START/+30SEC. per avviare la cottura.



NOTA

- Nella cottura multifase è possibile impostare due fasi di cottura.
- Se si imposta la funzione di scongelamento, verrà attivata automaticamente nella prima fase.
- Il timer di cottura e il menu automatico non possono essere impostati come una delle fasi multiple.

10. MENU AUTOMATICO

a In modalità standby, ruotando una volta la manopola a destra, comparirà "A-1".

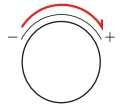

b Continuare a ruotare la manopola dei parametri per selezionare il menu richiesto.
Sono disponibili 8 menu automatici.

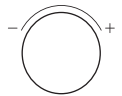

c Premere  START/+30SEC. per confermare.



d Ruotare la manopola per impostare il peso degli alimenti.

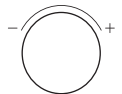

e Premere  START/+30SEC. per avviare la cottura.



TABELLA DEL MENU AUTOMATICO

MENU	PESO/ QUANTITÀ	DISPLAY	LIVELLO DI POTENZA
A-1 Riscaldamento automatico	200 g 400 g 600 g	200 g 400 g 600 g	P100
A-2 Verdure	200 g 300 g 400 g	200 g 300 g 400 g	P100
A-3 Pesce	250 g 350 g 450 g	250 g 350 g 450 g	P80
A-4 Carne	250 g 350 g 450 g	250 g 350 g 450 g	P100
A-5 Pasta	50 g (con 450 g di acqua fredda) 100 g (con 800 g di acqua fredda)	50 g 100 g	P80
A-6 Patate	200 g 400 g 600 g	200 g 400 g 600 g	P100
A-7 Pizza surgelata	200 g 400 g	200 g 400 g	P100/Griglia
A-8 Zuppe	200 ml 400 ml	200 400	P80

11. FUNZIONE DI BLOCCO PER BAMBINI

È possibile utilizzare tale funzione per impedire ai bambini di accendere accidentalmente il forno.

- a** Per attivare il blocco:
In modalità standby, tenere premuto  STOP/CANCEL per tre secondi.
Viene emesso un suono acustico e verrà visualizzata l'icona del blocco.



- b** Per disattivare il blocco:
In stato di blocco, tenere premuto  STOP/CANCEL per tre secondi.
Viene emesso un suono acustico.



12. FUNZIONE DI RICHIESTA

- a** Quando il forno è in fase di cottura, premere  Timer/Clock per visualizzare l'ora corrente sul display per tre secondi.



- b** Nello stato di cottura al microonde, premere  Microwave per conoscere il livello di potenza. Verrà visualizzato per tre secondi.



- c** Nella griglia e nello stato di cottura combinata, premere  Grill/Combi. per chiedere informazioni sulla modalità di cottura. Verrà visualizzato per tre secondi.



PULIZIA

Con cura e pulizia adeguata, il tuo apparecchio manterrà il suo aspetto estetico e rimarrà perfettamente funzionante per lungo periodo di tempo. Spiegheremo qui come curare e pulire correttamente il tuo apparecchio.



AVVERTENZE

- Il graffio del vetro dello sportello dell'apparecchio può trasformarsi in una crepa.
Non utilizzare raschietti per vetro, strumenti taglienti o abrasivi per la pulizia o detersivi.
- La superficie dell'apparecchio può danneggiarsi se non viene pulita adeguatamente. L'energia del microonde potrebbe fuoriuscire. Pulire regolarmente l'apparecchio e rimuovere immediatamente eventuali residui di cibo.
- Non immergere l'apparecchio in acqua né pulirlo sotto il flusso d'acqua.

Detergente di pulizia

Per garantire che le varie superfici dell'apparecchio non vengano danneggiate dall'utilizzo di un detergente sbagliato, rispettare le indicazioni seguenti. Lavare accuratamente i panni e spugne nuovi prima dell'uso.

Non utilizzare:



Detersivi aggressivi o abrasivi



Raschietti per metallo o vetro per la pulizia dei pannelli dello sportello



Raschietti per metallo o vetro per la pulizia della guarnizione dello sportello



Detersivi ad alto contenuto di alcol



Detersivi ad alto contenuto di alcol

PARTE ANTERIORE DELL'APPARECCHIO

Acqua calda saponata:

Pulire con un canovaccio e poi asciugare con un panno morbido.

Non utilizzare raschietti per metallo o vetro per la pulizia.

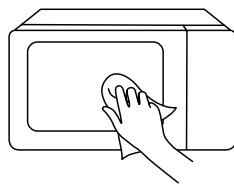

PULIZIA

PIASTRA ANTERIORE DELL'APPARECCHIO

Acqua calda saponata:

Pulire con un canovaccio e poi asciugare con un panno morbido.

Rimuovere immediatamente schizzi e macchie di calcare, grasso, amido e albumina. Queste macchie o schizzi possono dare origine alla corrosione del materiale. Non utilizzare detergenti per vetri o raschietti per metallo o vetro per la pulizia.

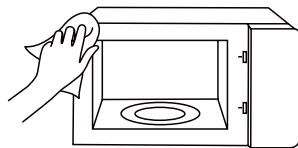

CAVITÀ DELL'APPARECCHIO

Acqua calda saponata o soluzione di aceto:

Pulire con un canovaccio e poi asciugare con un panno morbido. Non utilizzare spray detergente per forni o altri detergenti per forni che sono aggressivi o che sono fatti con materiali abrasivi. Inoltre, nemmeno le pagliette abrasive, spugne ruvide e detergenti per pentole sono adatte. Poiché questi prodotti possono graffiare la superficie. Lasciare asciugare completamente le superfici interne.

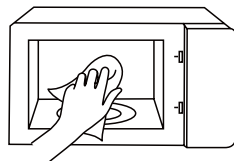

NICCHIA NEL VANO COTTURA

Panno bagnato:

L'acqua non può entrare nell'apparecchio attraverso la piastra girevole. Asciugare la piastra girevole con un panno.

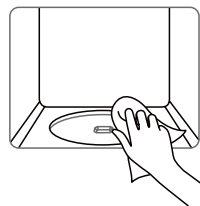

Piastra girevole e anello rotondo

Acqua calda saponata:

Quando si ripone la piastra girevole nella sua nicchia, la piastra girevole deve essere inserita correttamente.

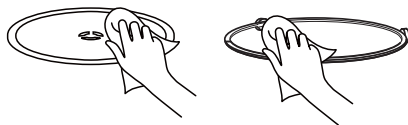

Pannello dello sportello

Detergente del vetro:

Pulire con un canovaccio. Non utilizzare raschietti per vetro.

RISOLUZIONE DEI PROBLEMI

Provare le soluzioni per ogni problema dopo aver utilizzato la tabella sottostante per verificare il problema. Se il forno a microonde continua a non funzionare correttamente, rivolgersi al servizio di assistenza autorizzato più vicino.

TROPPO	PROBABILE CAUSA	POSSIBILE SOLUZIONE
Il forno non si avvia	<ul style="list-style-type: none"> a. Il cavo elettrico del forno non è inserito. b. Lo sportello è aperto. c. È stato selezionato il funzionamento non corretto. 	<ul style="list-style-type: none"> a. Collegare alla presa di corrente. b. Chiudere lo sportello e riprovare. c. Verificare le indicazioni.
Arco elettrico o scintilla	<ul style="list-style-type: none"> a. Sono stati utilizzati articoli che non dovrebbero essere utilizzati in un forno a microonde. b. Il forno viene utilizzato quando è vuoto. c. Il cibo che si è rovesciato rimane nella cavità. 	<ul style="list-style-type: none"> a. Utilizzare solo pentole adatte al microonde. b. Non utilizzare mai un forno vuoto. c. Pulire la cavità con un panno umido.
Cibi cotti in modo non uniforme	<ul style="list-style-type: none"> a. Sono stati utilizzati articoli che non dovrebbero essere utilizzati in un forno a microonde. b. Il cibo non si è completamente scongelato. c. Il livello di potenza è insufficiente per il tempo di cottura. d. La pietanza non è stata girata o mescolata. 	<ul style="list-style-type: none"> a. Usare solo pentole adatte al microonde. b. Scongelare completamente gli alimenti. c. Utilizzare la potenza e il tempo di cottura adeguati. d. Mescolare o girare gli alimenti.
Cibi troppo cotti	Il tempo di cottura e il livello di potenza sono insufficienti.	Utilizzare la potenza e il tempo di cottura adeguati.
Alimenti poco cotti	<ul style="list-style-type: none"> a. Sono stati utilizzati articoli che non dovrebbero essere utilizzati in un forno a microonde. b. Il cibo non si è completamente scongelato. c. Le porte di ventilazione del forno sono limitate. d. Il tempo di cottura e il livello di potenza sono inadeguati. 	<ul style="list-style-type: none"> a. Utilizzare solo pentole adatte al microonde. b. Scongelare completamente gli alimenti. c. Verificare che le aperture di ventilazione del forno non siano ostruite. d. Utilizzare il tempo di cottura e il livello di potenza adeguati.
Scongelamento non corretto	<ul style="list-style-type: none"> a. Sono stati utilizzati articoli che non dovrebbero essere utilizzati in un forno a microonde. b. Livello di potenza e tempo di cottura inadeguati. c. Non sono stati girati o strofinati gli alimenti. 	<ul style="list-style-type: none"> a. Utilizzare solo pentole adatte al microonde. b. utilizzare il tempo di cottura e il livello di potenza consigliati. c. Scartare o girare il cibo.



Secondo la direttiva sui rifiuti di apparecchiature elettriche ed elettroniche (RAEE), i RAEE devono essere raccolti e smaltiti separatamente. Se in futuro si dovesse smaltire questo prodotto, si prega di non smaltirlo insieme ai rifiuti domestici. Portare il prodotto in un punto di raccolta RAEE, se disponibile.

#DetailsMatter

MANUEL D'INSTRUCTIONS

FOURS À MICRO-ONDES

MW3-AG20PE(BK) / MW3-AG20PE(WH)

Veillez consulter ce manuel d'instructions avant l'utilisation.

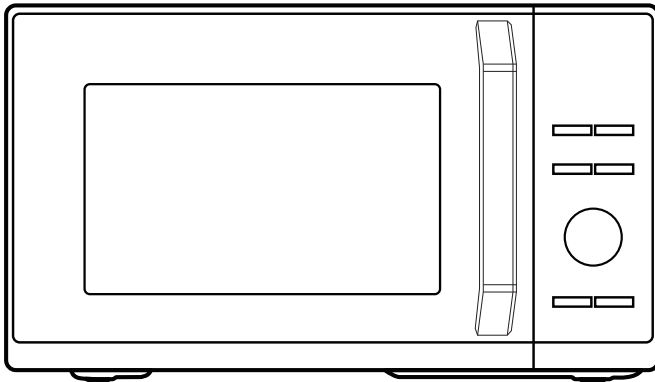

TOSHIBA

CONTENU

SÉCURITÉ DES PRODUITS

Précautions à prendre pour éviter une éventuelle exposition à une énergie micro-onde excessive.....	FR-01
Consignes de sécurité importantes.....	FR-03
Pour réduire les risques de blessures aux personnes installation de mise à la terre.....	FR-08
Nettoyage.....	FR-10
Ustensiles.....	FR-11
Matériaux que vous pouvez utiliser dans le four à micro-ondes.....	FR-12
Les matériaux ne pouvant pas être utilisés dans four à micro-ondes.....	FR-14

RÉGLAGE DU PRODUIT

Installation de votre four.....	FR-15
---------------------------------	-------

CONSEIL D'UTILISATION

Avant la première utilisation.....	FR-19
Utilisation.....	FR-20
1. Réglage de l'horloge.....	FR-21
2. Réglage du minuteur de cuisine.....	FR-22
3. Cuisson au micro-ondes.....	FR-22
4. Cuisson au gril.....	FR-23
5. Cuisson combinée.....	FR-24
6. Décongélation par le temps.....	FR-25
7. Décongélation par le poids.....	FR-25
8. Cuisson rapide.....	FR-26

9. Cuisson en plusieurs étapes	FR-26
10. Menu automatique	FR-27
11. Fonction de verrouillage pour les enfants	FR-29
12. Fonction d'information	FR-29
Nettoyage	FR-30

ENTRETIEN

Dépannage	FR-32
-----------------	-------



REMARQUE

AVANT D'UTILISER CE PRODUIT, VOUS DEVEZ LIRE, COMPRENDRE ET SUIVRE CES CONSIGNES. ASSUREZ-VOUS DE CONSERVER CETTE LISTE DE LIVRES AFIN DE LE CONSULTER ULTÉRIEUREMENT.

SÉCURITÉ DES PRODUITS

PRÉCAUTIONS À PRENDRE POUR ÉVITER UNE ÉVENTUELLE EXPOSITION À UNE ÉNERGIE MICRO-ONDES EXCESSIVE

- (a). N'essayez pas de faire fonctionner ce four avec la porte ouverte car cela peut entraîner une exposition dangereuse à l'énergie du micro-ondes. Il est important de ne pas briser ou modifier les verrouillages de sécurité.
- (b). Ne placez aucun objet entre la face avant du four et la porte et ne laissez pas de saleté ni de résidus de nettoyage s'accumuler sur les surfaces d'étanchéité.
- (c). **AVERTISSEMENT** : Si la porte ou les joints de la porte sont endommagés, le four ne doit pas être utilisé tant qu'il n'a pas été réparé par une personne compétente.

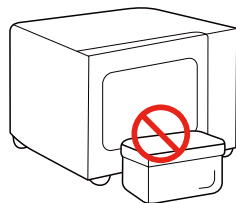

ADDENDUM

Si l'appareil n'est pas maintenu dans un bon état de propreté, sa surface pourrait se dégrader et affecter la durée de vie de l'appareil et conduire à une situation dangereuse.

SPÉCIFICATIONS

MODÈLE MW3-AG20PE(BK) / MW3-AG20PE(WH)

TENSION/FRÉQUENCE NOMINALE 230V ~ 50 Hz

PUISSANCE D'ENTRÉE NOMINALE (MICRO-ONDES) 1270 W

PUISSANCE DE SORTIE NOMINALE (MICRO-ONDES) 800 W

PUISSANCE D'ENTRÉE NOMINALE (GRILL) 1000 W

CONSOMMATION D'ÉLECTRICITÉ

Informations sur le produit concernant la consommation d'électricité et le temps maximum pour atteindre le mode de faible consommation applicable.

Mode veille	0,8 W
-------------	-------

Temps maximum nécessaire pour que le four à micro-ondes atteigne automatiquement le mode ou l'état de faible consommation applicable.	20 minutes
---	------------



REMARQUE

Toutes les images de ce manuel ne sont indiquées qu'à titre indicatif ; celles-ci peuvent être légèrement différentes de l'équipement acheté, veuillez vous référer au produit réel.

CONSIGNES IMPORTANTES CONCERNANT LA SÉCURITÉ



AVERTISSEMENT

Pour réduire le risque d'incendie, de choc électrique, de blessure ou d'exposition à une énergie excessive du four à micro-ondes lors de l'utilisation de votre appareil, suivez les précautions de base, notamment les suivantes :



Veillez lire et suivre les instructions spécifiques :
« **PRÉCAUTIONS À PRENDRE POUR ÉVITER UNE EXPOSITION POSSIBLE À UNE ÉNERGIE DE MICRO-ONDES EXCESSIVE** ».



Cet appareil peut être utilisé par des enfants âgés de 8 ans et plus et des personnes ayant des capacités physiques, sensorielles ou mentales réduites ou un manque d'expérience et de connaissances s'ils ont reçu une supervision ou des instructions concernant l'utilisation de l'appareil en toute sécurité et comprennent les dangers encourus. Cet appareil ne

doit pas être utilisé par des enfants pour jouer. Le nettoyage et l'entretien par l'utilisateur ne doivent pas être effectués par des enfants sans surveillance.



Gardez l'appareil et son cordon d'alimentation hors de portée des enfants de moins de 8 ans.

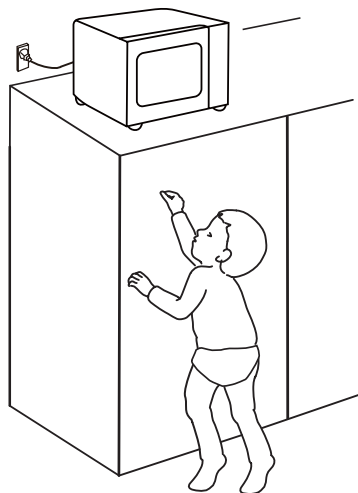



CONSIGNES IMPORTANTES CONCERNANT LA SÉCURITÉ

 Si le cordon d'alimentation est endommagé, il doit être remplacé par le fabricant, son agent de service ou des personnes ayant une qualification similaire afin d'éviter tout risque.

 **AVERTISSEMENT :** Assurez-vous que l'appareil soit éteint avant de remplacer la lampe afin d'éviter tout risque d'électrocution.

 **AVERTISSEMENT :** Il est dangereux pour toute personne autre qu'une personne compétente d'effectuer tout entretien ou réparation qui implique le retrait d'un couvercle qui protège contre l'exposition à l'énergie des micro-ondes.

 **AVERTISSEMENT :** Les liquides et autres aliments ne doivent pas être chauffés dans des récipients hermétiques car ils sont susceptibles d'exploser.

 Lorsque vous chauffez des aliments dans des récipients en plastique ou en papier, surveillez toujours le four en raison du risque d'inflammation.



 N'utilisez que des ustensiles adaptés aux fours à micro-ondes.

 En cas d'émission de fumée, éteignez ou débranchez l'appareil et gardez la porte fermée afin d'étouffer les flammes.

 Le chauffage des boissons aux micro-ondes peut entraîner une ébullition retardée, il faut donc faire attention lors de la manipulation du récipient.

 Le contenu des biberons et des petits pots pour bébés doit être agité ou secoué et la température vérifiée avant toute consommation, afin d'éviter les brûlures.

CONSIGNES IMPORTANTES CONCERNANT LA SÉCURITÉ

 **AVERTISSEMENT :**
Lorsque l'appareil fonctionne en mode combiné, les enfants ne doivent utiliser le four que sous la surveillance d'un adulte en raison des températures générées.

 Si le four n'est pas maintenu dans un état de propreté, sa surface pourrait se détériorer, ce qui pourrait nuire à la durée de vie de l'appareil et entraîner une situation dangereuse.

 N'utilisez que la sonde de température recommandée pour ce four (pour les fours équipés d'une sonde de température)

 Le four à micro-ondes doit être utilisé une fois la porte décorative ouverte. (pour les fours avec porte décorative.)

 Cet appareil doit être utilisé dans de façon domestique et similaire telle que :

1. zones de cuisine du personnel dans les magasins, bureaux et autres lieux de travail ;
2. par des clients dans des hôtels, des motels et d'autres lieux de type résidentiel ;
3. maisons de ferme ;
4. lieux de type chambres d'hôtes.

 Le four à micro-ondes est destiné à réchauffer des aliments et des boissons. Le séchage des aliments ou des vêtements et le chauffage des coussins chauffants, des pantoufles, des éponges, des tissus humides et autres peuvent entraîner un risque de blessure, d'inflammation ou d'incendie.

CONSIGNES IMPORTANTES CONCERNANT LA SÉCURITÉ

 L'appareil doit être utilisé de façon autonome.

 La face arrière des appareils doit être placée contre un mur.

 La température des surfaces accessibles peut être élevée lorsque l'appareil fonctionne.

 Le four doit être nettoyé régulièrement et tous les résidus alimentaires doivent être éliminés. Veuillez garder la zone du guide d'ondes propre. Utilisez un chiffon doux et humide pour le nettoyer lorsqu'il y a des résidus d'éclaboussures de nourriture sur la zone du guide d'ondes ou dans la cavité. Ne pas nettoyer les résidus alimentaires peut provoquer des étincelles inoffensives ou de la fumée dans la cavité du

micro-ondes. Cela peut également entraîner un décoloration de la cavité.

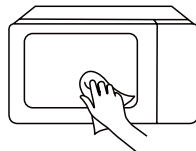

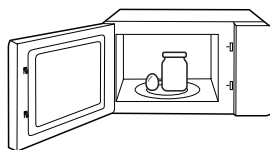

 Les œufs dans leur coquille et les œufs durs entiers ne doivent pas être chauffés dans des fours à micro-ondes car ils peuvent exploser, même après la fin du chauffage par micro-ondes.





 Le four à micro-ondes ne doit pas être placé dans une armoire à moins qu'il n'ait été testé dans une armoire.

CONSIGNES IMPORTANTES CONCERNANT LA SÉCURITÉ

 Les récipients métalliques pour aliments et boissons ne sont pas autorisés lors de la cuisson aux micro-ondes.

 L'appareil ne doit pas être nettoyé avec un nettoyeur à vapeur.

 Les appareils ne sont pas destinés à être actionnés au moyen d'une minuterie externe ou d'un système de télécommande séparé.

 L'appareil ne doit pas être installé derrière une porte décorative afin d'éviter une surchauffe. (Ceci ne s'applique pas aux appareils avec porte décorative.)

À LIRE ATTENTIVEMENT ET A CONSERVER
POUR RÉFÉRENCE ULTÉRIEURE

AFIN DE RÉDUIRE LE RISQUE DE BLESSURE PERSONNES - INSTALLATION DE MISE À LA TERRE

Cet appareil doit être mis à la terre. En cas de court-circuit électrique, la mise à la terre réduit le risque de choc électrique grâce à un fil d'échappement du courant électrique.

Cet appareil est équipé d'un cordon doté d'un fil de terre avec une fiche de terre. La fiche doit être branchée dans une prise correctement installée et mise à la terre.

AVERTISSEMENT - Une mauvaise utilisation de la mise à la terre peut entraîner un risque de choc électrique. Consultez un électricien ou un réparateur qualifié si les instructions de mise à la terre ne sont pas complètement comprises ou si vous avez des doutes quant à la mise à la terre correcte de l'appareil. S'il est nécessaire d'utiliser une rallonge, utilisez uniquement une rallonge à 3 fils.



DANGER

Risque de choc électrique :
Toucher certains composants internes peut
provoquer des blessures graves, voire la mort.
Ne démontez pas cet appareil.

AFIN DE RÉDUIRE LE RISQUE DE BLESSURE PERSONNES - INSTALLATION DE MISE À LA TERRE



**AVERTIS-
SEMENT**

Risque de choc électrique :

Une mauvaise mise à la terre peut entraîner un choc électrique. Ne branchez pas l'appareil sur une prise tant qu'il n'est pas installé et mis à la terre correctement.

1. Un cordon d'alimentation court est fourni pour réduire les risques de s'emmêler ou de trébucher sur un cordon plus long.
2. Si un long cordon ou une rallonge est utilisé :
 - (1). Les caractéristiques électriques indiquées du cordon ou de la rallonge doivent être au moins aussi élevées que les caractéristiques électriques de l'appareil.
 - (2). La rallonge doit être un cordon à 3 fils avec mise à la terre.
 - (3). Le cordon le plus long doit être disposé de sorte qu'il ne pende pas sur le plan de travail ou la table où il pourrait être tiré par des enfants ou que l'on puisse trébucher dessus par inadvertance.

NETTOYAGE

Veillez à débrancher l'appareil de l'alimentation électrique.

1. Nettoyez la cavité du four après utilisation avec un chiffon légèrement humide.
2. Nettoyez les accessoires de la manière habituelle à l'eau savonneuse.
3. L'encadrement et le joint de la porte ainsi que les pièces avoisinantes doivent être soigneusement nettoyés avec un chiffon humide lorsqu'ils sont sales.
4. N'utilisez pas de nettoyeurs abrasifs agressifs ni de grattoirs métalliques pointus pour nettoyer la vitre de la porte du four car ils peuvent rayer la surface, ce qui peut entraîner l'éclatement de la vitre.
5. Conseil pour le nettoyage --- Pour un nettoyage plus facile des parois de la cavité avec lesquelles les aliments cuits peuvent entrer en contact : placez un demi-citron dans un bol, ajoutez 300 ml (1/2 pinte) d'eau et faites bouillir à 100 % au micro-ondes pendant 10 minutes. Nettoyez le four à l'aide d'un chiffon doux et sec.

USTENSILES



Risque de blessures corporelles :

Il est dangereux pour toute personne autre qu'une personne compétente d'effectuer toute opération d'entretien ou de réparation qui implique le retrait d'un couvercle qui protège contre l'exposition à l'énergie des micro-ondes.. Voir les instructions sur « **Matériaux que vous pouvez utiliser dans le four à micro-ondes** » ou « **Les matériaux à ne pas utiliser dans le four à micro-ondes** »

Certains ustensiles non métalliques peuvent ne pas être utilisés en toute sécurité dans le micro-ondes. En cas de doute, vous pouvez tester l'ustensile en question en suivant la procédure ci-dessous.

Test des ustensiles :



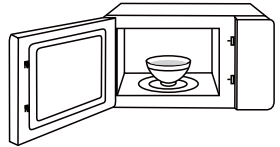



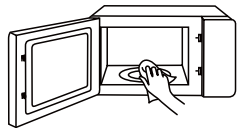









1. Remplissez un récipient allant au micro-ondes avec 1 tasse d'eau froide (250 ml) avec l'ustensile en question.
2. Cuire à puissance maximale pendant 1 min.
3. Testez soigneusement la température de l'ustensile. Si l'ustensile vide est chaud, ne l'utilisez pas pour la cuisson au micro-ondes.
4. Ne dépassez pas 1 min de temps de cuisson.



GARDEZ LA CAVITÉ ET LA ZONE DE GUIDE D'ONDE PROPRES



MATÉRIAUX QUE VOUS POUVEZ UTILISER DANS LE FOUR À MICRO-ONDES

USTENSILES	REMARQUES	
 Plat à rissoler	Suivez les instructions du fabricant. Le fond du plat de rissoler doit se trouver au moins 3/16 pouces (5 mm) au-dessus du plateau tournant. Une utilisation incorrecte peut entraîner la rupture du plateau tournant.	
 Articles pour le dîner	Uniquement pour les Micro-ondes. Suivez les instructions du fabricant. N'utilisez pas de vaisselle fêlée ou ébréchée.	
 Bocaux en verre	Retirez toujours le couvercle. Utilisez-le uniquement pour réchauffer les aliments jusqu'à ce qu'ils soient juste chauds. La plupart des bocaux en verre ne résistent pas à la chaleur et peuvent se briser.	
 Verrerie	Verrerie de four résistante à la chaleur uniquement. Veillez à ce qu'il n'y ait pas de garniture métallique. N'utilisez pas de plats fissurés ou ébréchés.	
 Sacs de cuisson au four	Suivez les instructions du fabricant. Ne fermez pas avec une attache métallique. Faites des fentes pour permettre à la vapeur de s'échapper.	
 Assiettes et gobelets en carton	À utiliser uniquement pour la cuisson/le réchauffement de courte durée. Ne laissez pas le four sans surveillance pendant la cuisson.	
 Serviettes en papier	À utiliser pour couvrir les aliments afin de réchauffer et d'absorber les graisses. À utiliser sous surveillance pour une cuisson de courte durée uniquement.	
 Papier sulfurisé	Utilisez-le comme couverture pour éviter les éclaboussures ou comme enveloppe pour la cuisson à la vapeur.	

MATÉRIAUX QUE VOUS POUVEZ UTILISER DANS LE FOUR À MICRO-ONDES

USTENSILES

REMARQUES



Plastique

Uniquement pour les Micro-ondes. Suivez les instructions du fabricant. Doit avoir l'étiquette « Compatible micro-ondes ». Certains récipients en plastique ramollissent à mesure que les aliments qu'ils contiennent deviennent chauds. Les « sacs bouillants » et les sacs en plastique bien fermés doivent être fendus, percés ou ventilés comme indiqué sur l'emballage.



Film plastique

Uniquement pour les Micro-ondes. Utiliser pour couvrir les aliments pendant la cuisson afin de retenir l'humidité. Ne laissez pas le film plastique toucher les aliments.

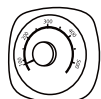

Thermomètres

Uniquement pour les Micro-ondes (thermomètres pour la viande et les bonbons).



Papier ciré

À utiliser comme couverture pour éviter les éclaboussures et retenir l'humidité.



LES MATÉRIAUX NE PEUVENT PAS ÊTRE UTILISÉS AU FOUR À MICRO-ONDES

USTENSILES

REMARQUES

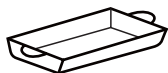

Plateau en aluminium

Peuvent provoquer des arcs électriques. Transférez les aliments dans un plat allant au micro-ondes.



Carton alimentaire avec poignée métallique

Peuvent provoquer des arcs électriques. Transférez les aliments dans un plat allant au micro-ondes.



Les ustensiles en métal ou garnis de métal

Le métal protège les aliments de l'énergie des micro-ondes.
Les garnitures métalliques peuvent provoquer des arcs électriques.



Liens torsadés en métal

Peut provoquer des arcs électriques et peut causer un incendie dans le four.



Sacs en papier

Peut provoquer un incendie dans le four.



Mousse plastique

La mousse plastique peut fondre ou contaminer le liquide à l'intérieur lorsqu'elle est exposée à une température élevée.



Bois

Le bois se dessèche lorsqu'il est utilisé dans le four à micro-ondes et peut se fendre ou se fissurer.



RÉGLAGE DU PRODUIT

INSTALLATION DE VOTRE FOUR

NOMS DES PIÈCES ET ACCESSOIRES DU FOUR À MICRO-ONDES

Retirez le four et tous les matériaux du carton et de la cavité du four.

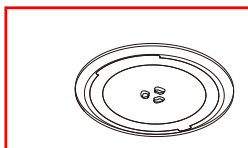

Plateau en verre

(Peut être utilisé sous toutes les fonctions)

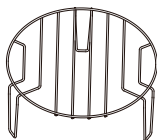

Grill (ne peut pas être utilisé dans un four à micro-ondes et doit être placé sur un plateau en verre)

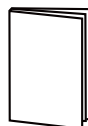

**Manuel
d'instructions**

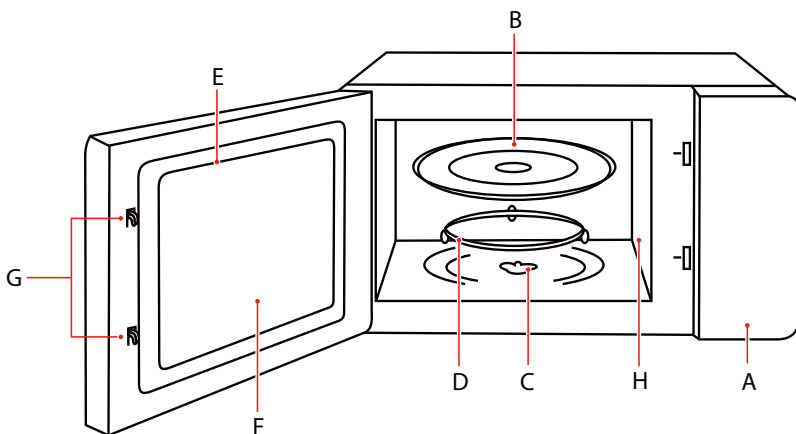

- | | |
|--|--|
| A. Panneau de configuration | E. Montage de la porte |
| B. Plateau en verre | F. Fenêtre d'observation |
| C. Arbre de plateau tournant | G. Système de verrouillage de sécurité |
| D. Montage de l'anneau du plateau tournant | H. Couvercle du guide d'ondes |



REMARQUE

En cas de différences entre l'appareil et les images dans ce manuel, l'appareil prévaut.

INSTALLATION DE VOTRE FOUR

INSTALLATION D'UN PLATEAU TOURNANT

Nettoyage du compartiment de cuisson et mise en place du plateau tournant.

Pour les nouvelles installations, assurez-vous que tout le ruban d'emballage et d'expédition ait été retiré de l'arbre du plateau tournant.

Avant d'utiliser l'appareil pour préparer des aliments pour la première fois, vous devez mettre le plateau tournant en place correctement. Vous devez nettoyer le compartiment de cuisson et les accessoires.

Comment mettre le plateau tournant en place :

1. Placez l'anneau du plateau tournant ③ dans le renforcement du compartiment de cuisson.
2. Placez le plateau en verre ① sur les anneaux du plateau tournant ③.

Ajustez les lignes incurvées en relief au centre du fond du plateau en verre entre les trois rayons de l'arbre.

Assurez-vous que le plateau en verre ① s'engage dans l'axe du plateau tournant ② au centre de la plaque du fond du compartiment de cuisson. Les rouleaux sur l'arbre doivent s'insérer à l'intérieur de la crête inférieure du plateau tournant

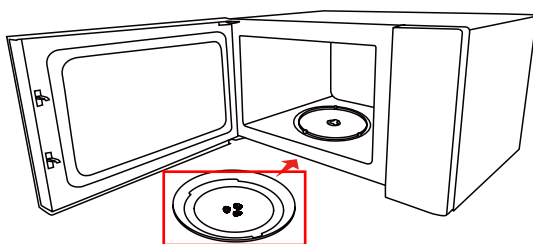
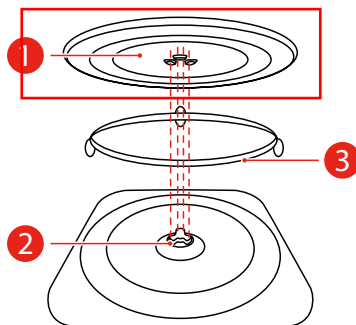

REMARQUE

- N'utilisez jamais l'appareil sans le plateau tournant. Assurez-vous qu'il est correctement engagé. Le plateau tournant peut tourner dans le sens des aiguilles d'une montre ou dans le sens inverse.
- Ne placez jamais le plateau en verre à l'envers. Le plateau en verre ne doit jamais être restreint.
- Le plateau en verre et l'anneau du plateau tournant doivent toujours être utilisés pendant la cuisson.
- Tous les aliments et contenants d'aliments sont toujours placés sur le plateau en verre pour la cuisson.
- Ne limitez jamais le mouvement du plateau tournant.
- Si le plateau en verre ou l'anneau du plateau tournant se fissure ou se casse, contactez votre centre de Service agréé le plus proche.

INSTALLATION DE VOTRE FOUR

INSTALLATION SUR Le PLAN DE TRAVAIL

Retirez tout le matériel contenu dans, y compris les accessoires. Vérifiez si le four présente des traces de dommage tels que des bosses ou une porte cassée. Ne pas installer si le four est endommagé.

Armoire : retirez le film protecteur s'il est trouvé sur la surface de l'armoire du four à micro-ondes. Ne retirez pas le couvercle du guide d'ondes fixé à la cavité du four et destiné à protéger le magnétron.

INSTALLATION

1. Sélectionnez une surface plane offrant suffisamment d'espace libre pour les orifices d'entrée et/ou de sortie.
 - a. La hauteur d'installation minimale est de 85 cm.
 - b. La surface arrière de l'appareil doit être placée contre un mur. Laissez un espace minimum de 30 cm au-dessus du four. un espace minimum de 20 cm est requis entre le four et les murs adjacents.
 - c. Ne retirez pas les pieds du bas du four.
 - d. Bloquer les ouvertures d'entrée et/ou de sortie peut endommager le four.
 - e. Placez le four aussi loin que possible des radios et des téléviseurs.
Le fonctionnement du four à micro-ondes peut causer des interférences à la réception de votre radio ou de votre télévision.

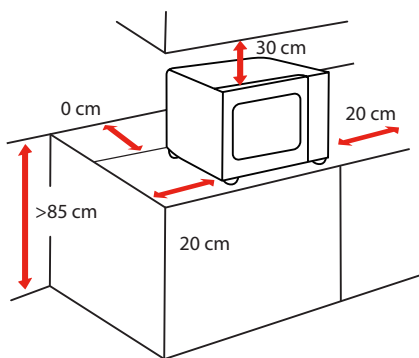

CÔTÉ	DISTANCE CM
Haut	30 cm
Gauche	20 cm
Droite	20 cm
Derrière	0 cm
Avant	Ouvrir

INSTALLATION DE VOTRE FOUR

2. Branchez votre four sur une prise domestique standard. Assurez-vous que la tension et la fréquence sont les mêmes que celles indiquées sur la plaque signalétique.



**AVERTISSE-
MENT**

- N'installez pas le four au-dessus d'une table de cuisson ou d'un autre appareil dégageant de la chaleur.
S'il est installé à proximité ou au-dessus d'une source de chaleur, le four pourrait être endommagé et la garantie serait annulée.

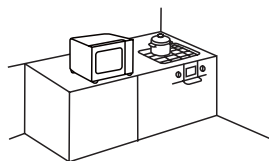

La surface accessible peut être chaude pendant le fonctionnement.

CONSEIL D'UTILISATION

AVANT LA PREMIÈRE UTILISATION

L'appareil peut dégager des odeurs désagréables lors de sa première utilisation.

Cette section vous indique ce que vous devez faire avant d'utiliser votre micro-ondes pour préparer des aliments pour la première fois. Lisez au préalable la section intitulée « **CONSIGNES DE SÉCURITÉ IMPORTANTES** » à la page 3.

Avant de pouvoir utiliser votre nouvel appareil, vous devrez mettre le plateau tournant correctement en place. Vous devez également nettoyer le compartiment de cuisson et les accessoires.



REMARQUE

- N'utilisez jamais l'appareil sans le plateau tournant.
- Assurez-vous qu'il est correctement engagé. Le plateau tournant peut tourner dans le sens des aiguilles d'une montre ou dans le sens inverse.

FONCTIONNEMENT

PANNEAU DE COMMANDE ET FONCTIONNALITÉS

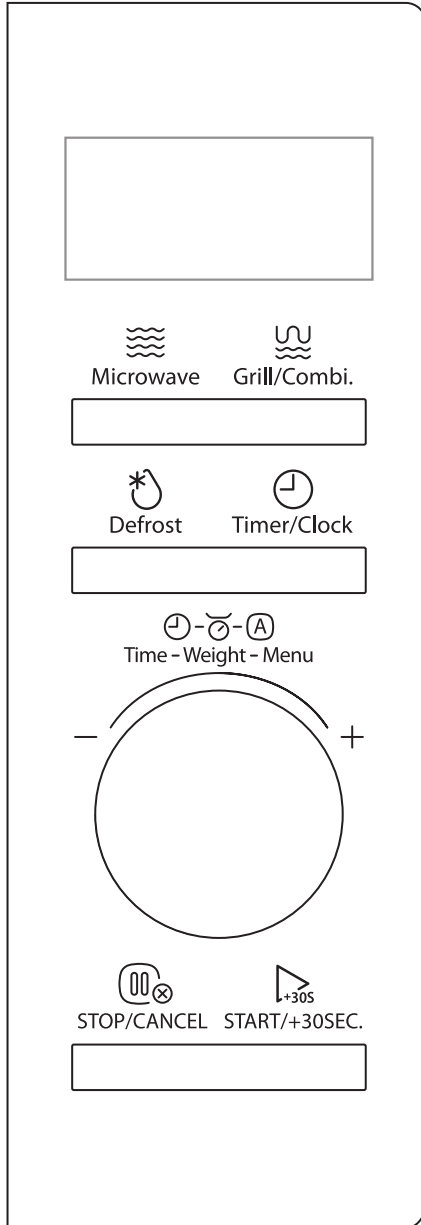

1. RÉGLAGE DE L'HORLOGE

a Appuyez deux fois sur  Timer/Clock, « 00:00 » apparaîtra.



b Tournez le bouton pour régler les heures.

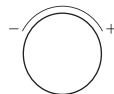

c Appuyez sur  Timer/Clock ou  START/+30SEC. pour confirmer les chiffres de l'heure.



ou



d Tournez le bouton pour régler les minutes.

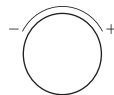

e Appuyez sur  Timer/Clock ou  START/+30SEC. pour confirmer. L'horloge est réglée.



ou



- L'horloge a un format d'affichage de 24 heures. Si l'horloge n'est pas réglée, l'appareil ne fonctionnera pas lorsqu'il sera alimenté.
- Pour réinitialiser l'horloge, répétez les étapes a à e.

2. RÉGLAGE DU MINUTEUR DE CUISINE

a Appuyez une fois sur  Timer/Clock, « 00:00 » apparaîtra.



b Tournez le bouton pour régler la durée souhaitée.
La durée maximale est « 95:00 ».

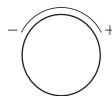

c Appuyez sur  START/+30SEC. pour confirmer. Le minuteur commence un compte à rebours.



- Le minuteur de cuisine est un minuteur.
- Aucun autre programme ne peut être réglé pendant la minuterie de cuisine.

3. CUISSON AU MICRO-ONDES

5 niveaux de puissance sont disponibles.

NIVEAU	PUISSANCE	AFFICHAGE
1	100 %	P100
2	80%	P80
3	50%	P50
4	30%	P30
5	10%	P10



Appuyez à plusieurs reprises sur Microwave pour choisir le niveau de puissance.

a ou

Appuyez une fois sur Microwave et tournez le bouton pour régler le niveau de puissance.

Les 5 niveaux de puissance sont disponibles.

Microwave



Microwave



b Appuyez sur  START/+30SEC. pour confirmer le niveau de puissance.

START/+30SEC.

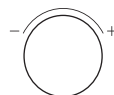
c Tournez le bouton pour régler le temps de cuisson, la valeur maximale du temps est « 95:00 ».



d Appuyez sur la touche  START/+30SEC. pour démarrer la cuisson.

START/+30SEC.

4. CUISSON AU GRIL

a Appuyez une fois sur  Grill/Combi, « G-1 » apparaîtra.

Grill/Combi.

b Appuyez sur  START/+30SEC. pour confirmer le mode.

START/+30SEC.

c Tournez le bouton pour régler le temps de cuisson, la valeur maximale du temps est « 95:00 ».

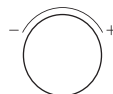

d Appuyez sur la touche  pour démarrer la cuisson.

START/+30SEC.

REMARQUE

• L'avertisseur sonore retentira pour vous rappeler de retourner les aliments pendant la cuisson.
S'il n'y a pas d'opération, le four continue de fonctionner.

5. CUISSON COMBINÉE

a Appuyez sur  Grill/Combi. à plusieurs reprises pour choisir le mode de cuisson souhaité. « C-1, C-2 » sont disponibles.

Grill/Combi.

ou
Appuyez une fois sur  Grill/Combi., et tournez le bouton pour choisir le mode de cuisson.



Grill/Combi.



b Appuyez sur  START/+30SEC. pour confirmer le mode.

START/+30SEC.

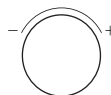
c Tournez le bouton pour régler le temps de cuisson, la valeur maximale du temps est « 95:00 ».



d Appuyez sur la touche  START/+30SEC. pour démarrer la cuisson.

START/+30SEC.

GRAPHIQUE DE CUISSON COMBINÉE

FONCTION	AFFICHAGE	PUISSANCE DU MICRO-ONDES	PUISSANCE DU GRIL
Combi. 1	C-1	55%	45%
Combi. 2	C-2	36%	64%

6. DÉCONGÉLATION PAR LE TEMPS

a Appuyez deux fois sur , puis « DEF2 » s'affichera.



b Tournez le bouton pour régler le temps de dégivrage souhaité, la valeur maximale du temps est « 95:00 ».

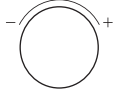

c Appuyez sur la touche  START/+30SEC. pour démarrer la décongélation.



REMARQUE

- L'avertisseur sonore retentira pour vous rappeler de retourner les aliments pendant la décongélation.
- S'il n'y a pas d'opération, le four continue de fonctionner.
- La puissance de décongélation est de P30, et ne peut être modifiée.

7. DÉCONGÉLATION PAR LE POIDS

a Appuyez une fois sur , ensuite « DEF1 » apparaîtra.



b Tournez le bouton pour régler le poids des aliments, la plage de poids est comprise entre 100 g et 2000 g .

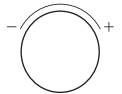



c Appuyez sur la touche  START/+30SEC. pour démarrer la décongélation.

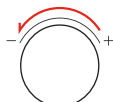

8. CUISSON RAPIDE

- a** Tournez le bouton vers la gauche pour régler un temps de cuisson à la puissance de 100%.
- b** Continuez à tourner le bouton pour régler le temps de cuisson. La valeur maximale du temps est « 95:00 ».
- c** Appuyez sur la touche  pour démarrer la cuisson.



- a** Appuyez sur  pour cuire les aliments à un niveau de puissance de 100% pendant 30 secondes. Chaque pression sur la même touche augmente le temps de 30 secondes dont le maximum est de « 95 :00 ».



9. CUISSON EN PLUSIEURS ÉTAPES

Exemple : pour décongeler pendant 5 minutes puis cuire aux micro-ondes à 80% pendant 7 minutes.

- a** Appuyez deux fois sur  Defrost, « DEF2 » s'affichera.



- b** Tournez le bouton pour régler le temps de décongélation souhaité à 5 minutes.



- c** Appuyez sur  Microwave à plusieurs reprises jusqu'à ce que « P80 » s'affiche.



- d** Appuyez sur  pour confirmer le niveau de puissance.



- e Tournez le bouton pour choisir le temps de cuisson de 7 minutes.

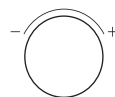

- f Appuyez sur la touche  pour démarrer la cuisson.



- La cuisson à deux étapes peut être réglée dans la cuisson à plusieurs étapes.
- Si vous réglez la fonction de décongélation, elle fonctionnera automatiquement au cours de la première phase.
- Le minuteur de cuisine, et le menu automatique ne peuvent pas être réglés comme étant l'une des étapes multiples.

10. MENU AUTOMATIQUE

- a En mode veille, tournez le bouton vers la droite une fois, puis « A-1 » s'affichera.

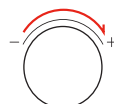

- b Continuez de tourner le bouton pour choisir le menu dont vous avez besoin.
Les 8 menus auto sont disponibles.



- c Appuyez sur  pour confirmer.



- d Tournez le bouton pour choisir le poids des aliments.



- e Appuyez sur la touche  pour démarrer la cuisson.



GRAPHIQUE DU MENU AUTOMATIQUE

MENU	POIDS/ QUANTITÉ	AFFICHAGE	NIVEAU DE PUISSANCE
A-1 Réchauffage automatique	200 g 400 g 600 g	200 g 400 g 600 g	P100
A-2 Légumes	200 g 300 g 400 g	200 g 300 g 400 g	P100
A-3 Poisson	250 g 350 g 450 g	250 g 350 g 450 g	P80
A-4 Viande	250 g 350 g 450 g	250 g 350 g 450 g	P100
A-5 Pâtes	50 g (avec 450 g d'eau froide) 100 g (avec 800 g d'eau froide)	50 g 100 g	P80
A-6 Pomme de terre	200 g 400 g 600 g	200 g 400 g 600 g	P100
A-7 Pizza congelée	200 g 400 g	200 g 400 g	P100/Gril
A-8 Soupe	200 ml 400 ml	200 400	P80

11. FONCTION DE VERROUILLAGE POUR LES ENFANTS

Cette fonction peut être utilisée pour empêcher les enfants d'allumer accidentellement le four.

- a** Pour activer le verrouillage :

En mode veille, appuyez sur  et maintenez-le enfoncé pendant trois secondes.

Un signal sonore est émis et l'icône de verrouillage apparaîtra.



- b** Pour désactiver le verrouillage :

En mode verrouillage, appuyez sur  et maintenez-le enfoncé pendant trois secondes.

Un signal sonore retentit.



12. FONCTION D'INFORMATION

- a** Lorsque le four est en cours de cuisson, appuyez sur  Timer/Clock, l'heure en cours s'affichera pendant trois secondes à l'écran.



- b** En mode de cuisson au micro-ondes, appuyez sur  Microwave pour vous renseigner sur le niveau de puissance. Il s'affichera pendant trois secondes.



- c** À l'état de gril et de cuisson combinée, appuyez sur  Grill/Combi. pour vous renseigner sur le mode de cuisson. Il s'affichera pendant trois secondes.



NETTOYAGE

Un entretien et un nettoyage approprié permettront à votre appareil de conserver son aspect et son pleine fonctionnalité pendant longtemps. Nous vous expliquerons dans ce documents la procédure d'entretien et de nettoyage correct de votre appareil.



AVERTISSEMENT

- La rayure du verre de la porte de l'appareil peut entraîner une fissure. N'utilisez pas de grattoir à verre, de produits de nettoyage ou de détergents agressif ou abrasifs.
- La surface de l'appareil peut être endommagée si elle n'est pas nettoyée correctement. L'énergie des micro-ondes peut s'échapper. Nettoyez régulièrement l'appareil et retirez immédiatement les restes de nourriture.
- Ne plongez pas l'appareil dans l'eau et ne le nettoyez pas sous un jet d'eau.

Agent de nettoyage

Pour vous assurer que les différentes surfaces ne soient pas endommagées par l'utilisation d'un mauvais produit de nettoyage, respectez les informations ci-dessous. Lavez soigneusement les nouveaux chiffons éponge avant utilisation.

Ne pas utiliser :



Produits de nettoyage agressifs ou abrasifs



Grattoirs en métal ou en verre pour nettoyer les panneaux de porte



Grattoirs en métal ou en verre pour nettoyer le joint de la porte



Tampons à récurer durs ou éponges



Produits de nettoyage à forte teneur en alcool

FAÇADE DE L'APPAREIL

Eau chaude savonneuse :

Nettoyez à l'aide d'un torchon puis essuyez avec un chiffon doux. N'utilisez pas de grattoirs en métal ou en verre pour le nettoyage.

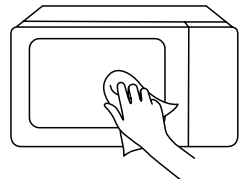

NETTOYAGE

PLAQUE AVANT DE L'APPAREIL

Eau chaude savonneuse :

Nettoyez à l'aide d'un torchon puis séchez avec un chiffon doux. Éliminez immédiatement les éclaboussures et les taches de calcaire, de graisse, d'amidon et d'albumine. Ces taches ou éclaboussures peuvent générer la formation de la corrosion. N'utilisez pas de nettoyeurs pour vitres ni de grattoirs en métal ou en verre pour nettoyer.

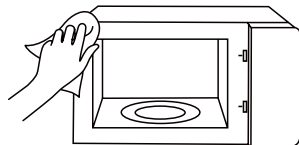

CAVITÉ DE L'APPAREIL

Eau chaude savonneuse ou solution vinaigrée :

Nettoyez en utilisation un torchon, puis séchez avec un chiffon doux. N'utilisez pas de spray pour four ou tout autre nettoyant agressif pour le four ou tout matériau abrasif. Évitez également d'utiliser les tampons à récurer, les éponges rugueuses et les nettoyeurs pour poêles. Ces accessoires laissent des rayures sur la surface. Laissez les surfaces intérieures sécher complètement.

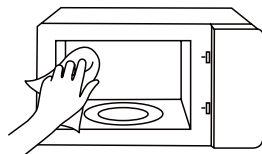

ENCASTREMENT DANS LE COMPARTIMENT DE CUISSON

Chiffon humide :

L'eau ne doit pas pénétrer dans l'appareil par l'entraînement du plateau tournant. Utilisez un chiffon pour faire sécher le lecteur du plateau tournant.

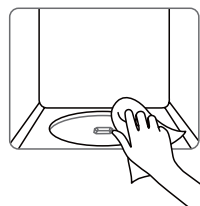
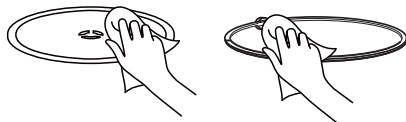

TABLE TOURNANTE ET BAGUE DE ROULEMENT

Eau chaude savonneuse :

Lorsque vous remplacez le plateau tournant dans son logement, il doit s'engager correctement.



PANNEAU DE PORTE

Nettoyant pour vitres :

Nettoyer avec un torchon. N'utilisez pas de grattoirs à verre.

DÉPANNAGE

Consultez le tableau ci-dessous pour analyser le problème et essayez les solutions pour chaque problème. Si le four à micro-ondes ne fonctionne toujours pas correctement, contactez le centre de service agréé le plus proche.

PROBLÈME	CAUSE POSSIBLE	SOLUTION POSSIBLE
Le four ne démarre pas	<ul style="list-style-type: none"> a. Le câble d'alimentation du four n'est pas branché. b. La porte est ouverte. c. Une mauvaise opération a été définie. 	<ul style="list-style-type: none"> a. Branchez le four sur une prise. b. Fermez la porte et réessayez. c. Vérifiez les instructions
Arcs ou étincelles	<ul style="list-style-type: none"> a. Des matériaux à ne pas utiliser dans le four à micro-ondes ont été utilisés. b. Le four fonctionne à vide. c. Des résidus d'aliments sont déposés dans la cavité. 	<ul style="list-style-type: none"> a. Utilisez uniquement des ustensiles de cuisine adaptés au micro-ondes. b. Ne faites pas fonctionner le four à vide. c. Nettoyez la cavité avec un chiffon doux et humide.
Aliments cuits de façon non homogène	<ul style="list-style-type: none"> a. Des matériaux à ne pas utiliser dans le four à micro-ondes ont été utilisés. b. Les aliments ne sont pas complètement décongelés. c. Temps de cuisson, niveau de puissance non adaptés. d. Les aliments n'ont pas été retournés ou remués. 	<ul style="list-style-type: none"> a. Utilisez uniquement des ustensiles de cuisine adaptés au micro-ondes. b. Décongelez complètement les aliments. c. Utilisez le temps de cuisson et le niveau de puissance appropriés. d. Retournez ou remuez les aliments.
Aliments trop cuits	Temps de cuisson, niveau de puissance non adaptés.	Utilisez le temps de cuisson et le niveau de puissance appropriés.
Aliments mal cuits	<ul style="list-style-type: none"> a. Des matériaux à ne pas utiliser dans le four à micro-ondes ont été utilisés. b. Les aliments ne sont pas complètement décongelés. c. Les orifices de ventilation du four sont obstrués. d. Temps de cuisson, niveau de puissance non adaptés. 	<ul style="list-style-type: none"> a. Utilisez uniquement des ustensiles de cuisine adaptés au micro-ondes. b. Décongelez complètement les aliments. c. Vérifiez que les orifices de ventilation du four ne sont pas obstrués. d. Utilisez le temps de cuisson et le niveau de puissance appropriés
Décongélation incorrecte	<ul style="list-style-type: none"> a. Des matériaux à ne pas utiliser dans le four à micro-ondes ont été utilisés. b. Temps de cuisson, niveau de puissance non adaptés. c. Les aliments n'ont pas été retournés ou remués. 	<ul style="list-style-type: none"> a. Utilisez uniquement des ustensiles de cuisine adaptés au micro-ondes. b. Utilisez le temps de cuisson et le niveau de puissance appropriés. c. Retournez ou remuez les aliments.



Conformément à la Directive sur les Déchets d'équipements électriques et électroniques (WEEE), les déchets doivent être triés, collectés et traités séparément. Si, dans le futur, vous devez vous débarrasser de ce produit, il NE faut PAS le jeter avec les ordures ménagères. Il faut apporter ce produit à un point de collecte WEEE disponible.

#DetailsMatter

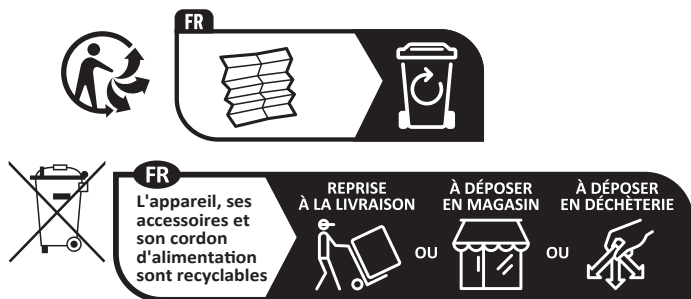

Points de collecte sur www.quefairedemesdechets.fr
Privilégiez la réparation ou le don de votre appareil !

GEBRUIKSHANDLEIDING

MAGNETRONOVEN

MW3-AG20PE(BK) / MW3-AG20PE(WH)

Lees deze gebruikshandleiding vóór gebruik.

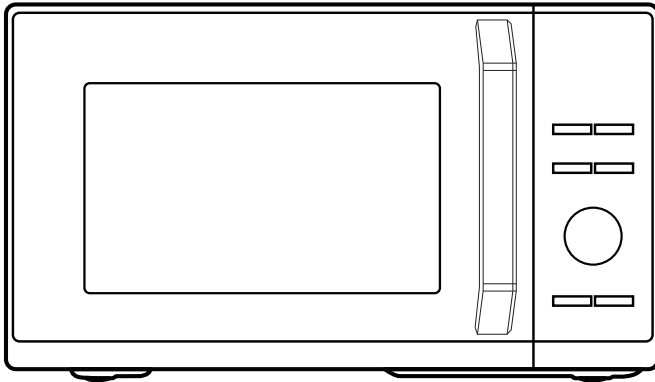

TOSHIBA

Inhoudsopgave

PRODUCTVEILIGHEID

Voorzorgsmaatregelen om mogelijke blootstelling aan te veel microgolvenenergie te voorkomen	NL-01
Belangrijke veiligheidsinstructies.....	NL-03
Om het risico op letsel voor personen te verminderen, moet de installatie worden geaard	NL-08
Reiniging	NL-10
Keukengerei	NL-11
Materialen die u in een magnetronoven kunt gebruiken	NL-12
Materialen die niet in een magnetronoven kunnen worden gebruikt	NL-14

PRODUCTINSTELLING

Uw oven instellen.....	NL-15
------------------------	-------

GEBRUIKSAANWIJZINGEN

Vóór het eerste gebruik	NL-19
Bediening.....	NL-20
1. De klok instellen	NL-21
2. De kookwekker instellen	NL-22
3. Koken met de magnetron	NL-22
4. Koken met de grill	NL-23
5. Koken met de combinatiefunctie	NL-24
6. Ontdooien op tijd	NL-25
7. Ontdooien op gewicht	NL-25
8. Snel koken	NL-26

9. Koken met meerdere fasen	NL-26
10. Automatisch menu	NL-27
11. Kinderslotfunctie	NL-29
12. Controlefunctie	NL-29
Reiniging	NL-30

ONDERHOUD

Problemen oplossen	NL-32
--------------------------	-------



OPMERKING

LEES, BEDRIJP EN VOLG DEZE INSTRUCTIES
VOORDAT U DIT PRODUCT IN GEBRUIK NEEMT.
ZORG ERVOOR DEZE DOCUMENTATIE TE
BEWAREN VOOR TOEKOMSTIG GEBRUIK.

PRODUCTVEILIGHEID

VOORZORGSMAATREGELEN OM MOGELIJKE BLOOTSTELLING AAN TE VEEL MICROGOLFENERGIE TE VOORKOMEN

- (a). Probeer deze oven niet te gebruiken met de deur open, aangezien dit kan leiden tot schadelijke blootstelling aan microgolven. Het is belangrijk om niet met de veiligheidsvergrendelingen te knoeien of deze te verbreken.
- (b). Plaats geen voorwerpen tussen de voorkant van de oven en de deur en laat geen vuil of resten van schoonmaakmiddelen ophopen op de afdichtingsoppervlakken.
- (c). **WAARSCHUWING:** Als de deur of deurafdichtingen beschadigd zijn, mag de oven niet worden gebruikt voordat deze door een bevoegd persoon is gerepareerd.

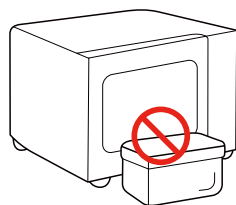

AANVULLING

Als het apparaat niet goed schoon wordt gehouden, kan het oppervlak ervan degraderen en wordt de levensduur van het apparaat beïnvloed, wat tot gevaarlijke situaties kan leiden.

SPECIFICATIES

MODEL	MW3-AG20PE(BK) / MW3-AG20PE(WH)
NOMINALE SPANNING/FREQUENTIE	230 V~ 50 Hz
NOMINAAL INGANGSVERMOGEN (MAGNETRON)	1270 W
NOMINAAL UITGANGSVERMOGEN (MAGNETRON)	800 W
NOMINAAL INGANGSVERMOGEN (GRILL)	1000 W

ENERGIEVERBRUIK

Productinformatie voor stroomverbruik en maximale tijd om toepasselijke spaarstand te bereiken.

Stand-bymodus	0.8 W
De maximale tijd die de magnetronoven nodig heeft om automatisch de stand of toestand voor laag energieverbruik te bereiken.	20 minuten



OPMERKING

Alle afbeeldingen in deze handleiding zijn uitsluitend bedoeld ter illustratie; deze kunnen enigszins afwijken van de aangeschafte apparatuur, raadpleeg het daadwerkelijke product.

BELANGRIJKE VEILIGHEIDSINSTRUCTIES



WAAR- SCHUWING

Om het risico op brand, elektrische schokken, persoonlijk letsel of blootstelling aan te veel energie van de magnetron te verminderen tijdens het gebruik van uw apparaat, dient u algemene voorzorgsmaatregelen te volgen, waaronder de volgende:



Lees en volg de specifieke: **"VOORZORGSMAATREGELEN OM MOGELIJKE BLOOTSTELLING AAN TE VEEL MICROGOLFENERGIE TE VOORKOMEN"**.



Dit apparaat mag worden gebruikt door kinderen van 8 jaar en ouder en door personen met verminderde lichamelijke, zintuiglijke of mentale capaciteiten, of met een gebrek aan kennis en ervaring, vooropgesteld zij onder toezicht staan of instructies hebben gekregen over het veilige gebruik van het apparaat en de betrokken gevaren begrijpen. Laat kinderen het apparaat niet als

speelgoed gebruiken. Reiniging en onderhoud mogen niet worden uitgevoerd door kinderen zonder toezicht.



Houd het apparaat en de kabel buiten bereik van kinderen jonger dan 8 jaar.

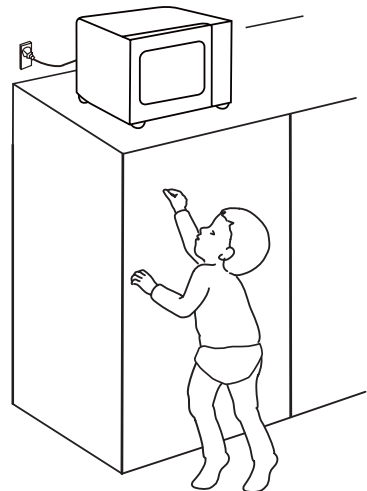

BELANGRIJKE VEILIGHEIDSINSTRUCTIES

 Als de voedingskabel is beschadigd, moet deze worden vervangen door de fabrikant, diens servicevertegenwoordiger of een vergelijkbaar gekwalificeerde persoon om gevaarlijke situaties te voorkomen.

 **WAARSCHUWING:** Zorg ervoor dat het apparaat is uitgeschakeld voordat u de lamp vervangt, om het risico op een elektrische schok te voorkomen.

 **WAARSCHUWING:** Het is gevaarlijk voor iemand anders dan een bevoegd persoon om onderhouds- of reparatiewerkzaamheden uit te voeren waarbij een afdekking moet worden verwijderd die bescherming biedt tegen blootstelling aan micro-golfenergie.

 **WAARSCHUWING:** Vloeistoffen en soorten voedsel mogen niet in afgesloten

containers worden verwarmd, aangezien deze kunnen ontploffen.

 Houd bij het verwarmen van voedsel in plastic of papieren containers de oven in de gaten, omdat er een kans bestaat op ontsteking.



 Gebruik uitsluitend keukengerei dat geschikt is voor gebruik in magnetronovens.

 Als u rook waarneemt, schakelt u het apparaat uit of haalt u de stekker uit het stopcontact en houdt u de deur gesloten om eventuele vlammen te doven.

 Bij het verwarmen van drank in de magnetron kan de vloeistof vertraagd beginnen te koken. Wees daarom voorzichtig bij het hanteren van de container.

BELANGRIJKE VEILIGHEIDSINSTRUCTIES

 De inhoud van zuigflessen en potjes babyvoeding moet vóór consumptie worden geroerd of geschud en de temperatuur moet worden gecontroleerd om brandwonden te voorkomen.

 **WAARSCHUWING:** Wanneer het apparaat wordt gebruikt in de combinatiemodus, mogen kinderen de oven vanwege de gegenereerde temperaturen alleen onder toezicht van een volwassene gebruiken.

 Als u de oven niet schoon houdt, kan dit leiden tot degradatie van het oppervlak, wat een negatieve invloed kan hebben op de levensduur van het apparaat en mogelijk tot gevaarlijke situaties kan leiden.

 Gebruik uitsluitend de temperatuursonde die voor deze oven wordt aanbevolen. (voor ovens met de mogelijkheid om een temperatuursonde te gebruiken.)

 De magnetronoven moet worden bediend met de decoratieve deur open. (voor ovens met een decoratieve deur.)

 Dit apparaat is bestemd voor gebruik voor huishoudelijke en soortgelijke toepassingen, zoals:

1. personeelskeukens in winkels, kantoren en andere werkomgevingen;
2. door gasten in hotels, motels en andere woonomgevingen;
3. in boerderijen;
4. in bed & breakfast-omgevingen.

BELANGRIJKE VEILIGHEIDSINSTRUCTIES

 De magnetronoven is bestemd voor het verwarmen van voedsel en drank. Het drogen van voedsel of kleding en het verwarmen van verwarmingskussens, pantoffels, sponzen, vochtige doeken en dergelijke kan leiden tot het risico op letsel, ontsteking of brand.

 Het apparaat is bestemd voor vrijstaand gebruik.

 De achterkant van de apparaten moet tegen een muur worden geplaatst.

 De temperatuur van toegankelijke oppervlakken kan hoog zijn wanneer het apparaat in werking is.

 De oven moet regelmatig worden schoongemaakt en eventuele voedselresten moeten worden verwijderd. Houd de zone rondom de golfgeleider schoon.

Gebruik een zachte, vochtige doek om het schoon te maken als er etensresten rondom de golfgeleider of in de ovenruimte zitten. Als u de voedselresten niet schoonmaakt, kunnen er onschadelijke vonken of wat rook in de magnetronruimte ontstaan; er kan ook verkleuring van de ovenruimte optreden.

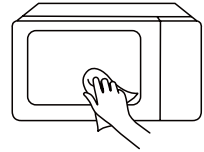

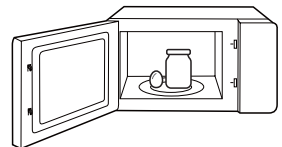

 Eieren in de schaal en hele hardgekookte eieren mogen niet in de magnetron worden verwarmd, omdat deze kunnen ontploffen, zelfs nadat de verwarming in de magnetron is beëindigd.





BELANGRIJKE VEILIGHEIDSINSTRUCTIES

 De magnetronoven mag niet in een kast worden geplaatst tenzij deze in een kast is getest.

 Metalen containers voor voedsel en drank zijn niet toegestaan tijdens het koken in de magnetron.

 Het apparaat mag niet worden schoongemaakt met een stoomreiniger.

 De apparaten zijn niet bedoeld om te worden bediend door middel van een externe timer of een afzonderlijk afstandsbedieningssysteem.

 Om oververhitting te voorkomen, mag het apparaat niet achter een decoratieve deur worden geïnstalleerd. (Dit geldt niet voor apparaten met decoratieve deur.)

ZORGVULDIG LEZEN EN BEWAREN VOOR
TOEKOMSTIG GEBRUIK

OM HET RISICO OP LETSEL VOOR PERSONEN TE VERMINDEREN, MOET DE INSTALLATIE WORDEN GEAARD

Dit apparaat moet worden geaard. In het geval van een elektrische kortsluiting vermindert aarding het risico op een elektrische schok omdat het een ontsnappingsdraad heeft voor de elektrische stroom.

Dit apparaat is voorzien van een kabel met een aardingsdraad en een geaarde stekker. De stekker moet in een stopcontact worden gestoken dat op de juiste manier is geïnstalleerd en geaard.

WAARSCHUWING - Verkeerd gebruik van de aarding kan een risico op elektrische schokken vormen. Raadpleeg een gekwalificeerde elektricien of onderhoudsmonteur als u de aardingsinstructies niet volledig begrijpt of als u twijfelt of het apparaat goed geaard is.

Als een verlengsnoer moet worden gebruikt, gebruik dan uitsluitend een 3-aderig verlengsnoer.



Risico op elektrische schokken:
Het aanraken van bepaalde interne componenten
kan ernstig of zelfs faal letsel veroorzaken.
Ontmantel dit apparaat niet.

OM HET RISICO OP LETSEL VOOR PERSONEN TE VERMINDEREN, MOET DE INSTALLATIE WORDEN GEAARD



**WAAR-
SCHUWING**

Risico op elektrische schokken:

Verkeerd gebruik van de aarding kan leiden tot elektrische schokken. Sluit het apparaat pas aan op het stopcontact nadat deze correct is geïnstalleerd en geaard.

1. Er is een korte voedingskabel meegeleverd om de risico's te verminderen die voortvloeien uit het verstrikt raken in of struikelen over een langere kabel.
2. Als een lange kabel of verleng snoer wordt gebruikt:
 - (1). Het aangegeven elektrische vermogen van de kabelset of het verlengsnoer moet minstens even groot zijn als de elektrische specificaties van het apparaat.
 - (2). Het verlengsnoer moet een geaard 3-aderig snoer zijn.
 - (3). De langere kabel moet zodanig worden geplaatst dat het niet over het aanrecht of tafelblad hangt of waar kinderen eraan kunnen trekken of er onbedoeld over kunnen struikelen.

REINIGING

Koppel het apparaat los van het stopcontact.

1. Reinig de ovenruimte na gebruik met een licht vochtige doek.
2. Reinig de accessoires op de gebruikelijke manier in een sopje.
3. Het deurframe, de afdichting en aangrenzende delen moeten zorgvuldig worden gereinigd met een vochtige doek wanneer ze vuil zijn geworden.
4. Gebruik geen agressieve schuurmiddelen of scherpe metalen schrapers om het glas van de ovendeur schoon te maken, aangezien deze krassen op het oppervlak kunnen veroorzaken, waardoor het glas kan barsten.
5. Schoonmaaktip---Om de wanden van de ovenruimte waarmee het gekookte voedsel in contact kan komen gemakkelijker te reinigen: Plaats een halve citroen in een kom, voeg 300 ml (1/2 pint) water toe en verhit gedurende 10 minuten op 100% magnetronvermogen. Veeg de oven schoon met een zachte, droge doek.

GEREEDSCHAP



VOORZICHTIGHEID

Risico op persoonlijk letsel:
Het is gevaarlijk voor iemand anders dan een bevoegd persoon om onderhouds- of reparatiewerkzaamheden uit te voeren waarbij een afdekking moet worden verwijderd die bescherming biedt tegen blootstelling aan microgolvenenergie. Zie de instructies onder "**Materialen die u in de magnetronoven kunt gebruiken**" of "**Materialen die niet in de magnetronoven kunnen worden gebruikt**".
Het kan zijn dat bepaald niet-metalen keukengerei onveilig is om in de magnetron te gebruiken. U kunt het keukengerei in geval van twijfel volgens de procedure hieronder testen.

Keukengerei testen:

1. Vul een voor magnetrons geschikte container met 1 kopje koud water (250ml), samen met het betreffende keukengerei.
2. Kook gedurende 1 minuut op maximaal vermogen.
3. Raak het keukengerei voorzichtig aan. Als het lege keukengerei warm is, gebruik het dan niet in de magnetron.
4. Kook niet langer dan 1 minuut.

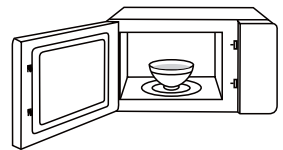





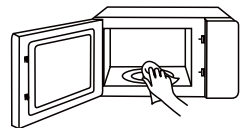











OPMERKING

HOUD DE KOOKRUIMTE
EN ZONE RONDOM DE
GOLFGELEIDER SCHOON



MATERIALEN DIE U IN DE MAGNETRON- OVEN KUNT GEBRUIKEN

GEREEDSCHAP	OPMERKINGEN	
 Bruiningschaal	Volg de instructies van de fabrikant. De bodem van de bruiningschaal moet zich minimaal 5 mm (3/16 inch) boven het draaiplateau bevinden. Het draaiplateau kan breken in het geval van verkeerd gebruik.	
 Servies	Alleen geschikt voor magnetrons Volg de instructies van de fabrikant. Gebruik geen gebarsten of afgebroken schotels.	
 Glazen potten	Verwijder altijd deksels. Alleen gebruiken om voedsel op te warmen tot het net warm is. De meeste glazen potten zijn niet hittebestendig en kunnen breken.	
 Glaswerk	Alleen hittebestendig ovenglaswerk. Zorg ervoor dat er geen metalen rand aanwezig is. Gebruik geen gebarsten of afgebroken schotels.	
 Kookzakken voor ovengebruik	Volg de instructies van de fabrikant. Niet sluiten met metalen binders. Maak spleten zodat stoom kan ontsnappen.	
 Papieren borden en kopjes	Slechts voor korte tijd koken/opwarmen. Laat de oven tijdens het koken niet onbeheerd achter.	
 Keukenrol	Gebruik om voedsel af te dekken voor het opwarmen en het absorberen van vet. Slechts voor korte tijd koken en onder toezicht houden.	
 Bakpapier	Gebruik als een afdekking om spetteren te voorkomen of als een omwikkeling bij het stomen.	

MATERIALEN DIE U IN DE MAGNETRON- OVEN KUNT GEBRUIKEN

GEREEDSCHAP

OPMERKINGEN



Plastic

Alleen geschikt voor magnetrons Volg de instructies van de fabrikant. Moet voorzien zijn van het label "Geschikt voor magnetrons". Sommige plastic containers worden zachter naargelang het voedsel erin heet wordt. "Kookzakken" en goed gesloten plastic zakken moeten worden gesneden, doorgeprikt of geventileerd zoals aangegeven op de verpakking.



Huishoudfolie

Alleen geschikt voor magnetrons Gebruik om voedsel af te dekken tijdens het koken geen vocht te verliezen. Zorg ervoor dat huishoudfolie geen contact maakt met het voedsel.



Thermometers

Alleen geschikt voor magnetrons (vlees- en snoepthermometers).



Waspapier

Gebruik als een afdekking om spetteren te voorkomen en geen vocht te verliezen.



MATERIALEN DIE NIET IN DE MAGNETRO- NOVEN KUNNEN WORDEN GEBRUIKT

GEREEDSCHAP

OPMERKINGEN



Aluminium bak

Kan vonkvorming veroorzaken. Plaats het voedsel in een schaal geschikt voor magnetrons.



Voedseldoos met metalen handvat

Kan vonkvorming veroorzaken. Plaats het voedsel in een schaal geschikt voor magnetrons.



Metaal of met metaal afgewerkt keukengerei

Metaal schermt het voedsel af tegen microgolvenenergie. Metalen afwerkingen kunnen vonkvorming veroorzaken.



Metalen binders

Kunnen vonkvorming en brand in de oven veroorzaken.

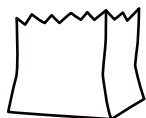

Papieren zakken

Kan brand in de oven veroorzaken.



Plastic schuim

Plastic schuim kan smelten of de vloeistof daarin verontreinigen bij blootstelling aan hoge temperaturen.



Hout

Hout droogt uit bij gebruik in de magnetronoven en kan splijten of barsten.



PRODUCTINSTELLING

UW OVEN INSTELLEN

NAAM VAN MAGNETRONONDERDELEN EN ACCESSOIRES

Haal de oven en alle materialen uit de doos en ovenruimte.

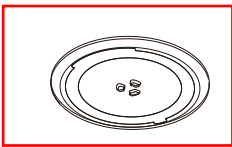

Glazen schaal

(Kan onder alle functies worden gebruikt)

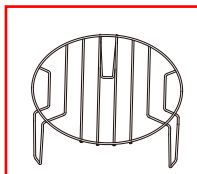

Grillrooster (kan niet met de magnetronfunctie worden gebruikt en moet op het glazen draaiplateau worden geplaatst)

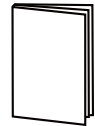

Gebruikshandleiding

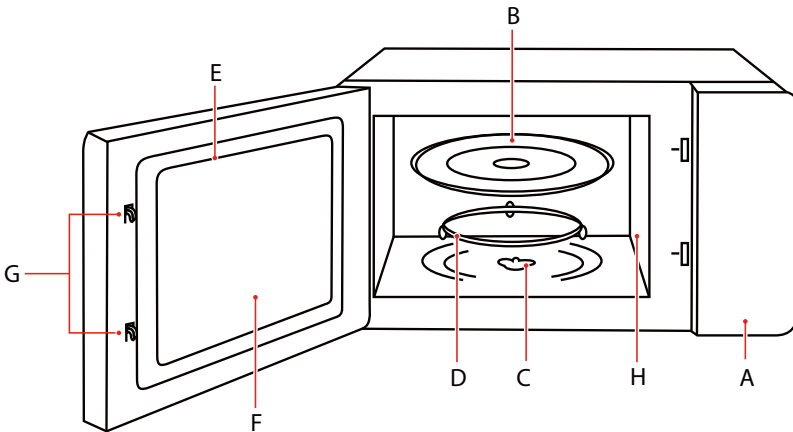

A. Bedieningspaneel

B. Glazen draaiplateau

C. As van draaiplateau

D. Ringenheid draaiplateau

E. Deurinrichting

F. Kijkvenster

G. Veiligheidsvergrendelingsysteem

H. Afdekking van golfgeleider



OPMERKING

In geval van verschillen tussen het apparaat en de afbeeldingen in deze handleiding, krijgt het product voorrang.

UW OVEN INSTELLEN

DRAAIPLATEAU INSTALLEREN

Maak de kookruimte schoon en plaats het draaiplateau.

Zorg er bij nieuwe installaties voor dat alle verpakings- en verzendtape van de as van het draaiplateau is verwijderd.

Voordat u het apparaat voor de eerste keer gebruikt om voedsel te bereiden, moet het draaiplateau correct op zijn plaats worden gezet. Ook moeten de kookruimte en accessoires worden gereinigd.

Het draaiplateau op zijn plek zetten:

1. Plaats de ringinrichting van het draaiplateau ③ in de uitsparing in de kookruimte.
2. Plaats de glazen schaal ① op de draaiplateauring ③. Plaats de verhoogde, gebogen lijnen in het midden onderop het glazen draaiplateau tussen de drie spaken van de as.

Zorg ervoor dat het glazen draaiplateau ① vast komt te zitten aan zijn as ② in het midden van de bodem van de kookruimte. De rollers op de as moeten in de onderrand van het draaiplateau passen.

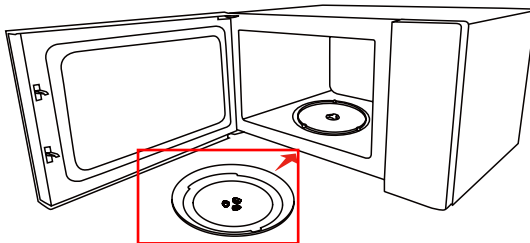
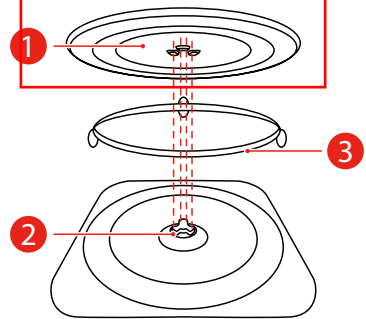

OPMERKING

- Gebruik het apparaat nooit zonder het draaiplateau. Zorg ervoor dat deze goed past. Het draaiplateau kan rechtsom of linksom draaien.
- Plaats de glazen schaal nooit ondersteboven. De glazen schaal mag nooit worden belemmerd.
- Tijdens het koken moeten zowel de glazen schaal als de draaiplateauring worden gebruikt.
- Alle voedsel en containers met voedsel moeten tijdens het koken altijd op de glazen schaal worden geplaatst.
- Belemmer nooit de beweging van het draaiplateau.
- Als de glazen schaal of de ringinrichting van het draaiplateau barst of breekt, neem dan contact op met het dichtstbijzijnde geautoriseerde servicecentrum.

UW OVEN INSTELLEN

INSTALLATIE OP EEN AANRECHT

Verwijder alle verpakkingsmaterialen en accessoires. Inspecteer de oven op schade zoals deuken of een gebroken deur. Installeer nooit een beschadigde oven.

Behuizing: Verwijder alle beschermlagen van het oppervlak van de magnetronbehuizing. Verwijder niet de afdekking van de golfgeleider die aan de ovenruimte is bevestigd om de magnetron te beschermen.

INSTALLATIE

1. Kies een vlak oppervlak dat voldoende open ruimte biedt voor de inlaat- en/of uitlaatopeningen.
 - a. De minimale installatiehoogte is 85 cm.
 - b. De achterkant van het apparaat moet tegen een muur worden geplaatst. Laat een minimale ruimte van 30 cm boven de oven vrij. Er is een minimale afstand van 20 cm vereist tussen de oven en alle aangrenzende wanden.
 - c. Verwijder nooit de voetstukken van de onderzijde van de oven.
 - d. Het blokkeren van de inlaat- en/of uitlaatopeningen kan de oven beschadigen.
 - e. Plaats de oven zo ver mogelijk uit de buurt van radio's en tv.
Het gebruik van een magnetron kan interferentie veroorzaken in uw radio- of tv-ontvangst.

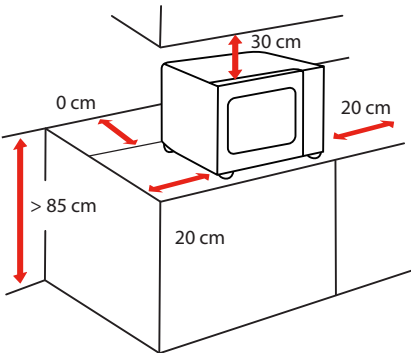

ZIJKANT	AFSTAND CM
Bovenkant	30 cm
Links	20 cm
Rechts	20 cm
Achter	0 cm
Voorkant	Open

UW OVEN INSTELLEN

2. Sluit de magnetronoven aan op een standaard huishoudelijk stopcontact. Controleer of de spanning en frequentie hetzelfde zijn als de spanning en frequentie aangegeven op het typeplaatje.



**WAAR-
SCHUWING**

- Installeer de oven niet boven een kookplaat of ander warmteproducerend apparaat. Als de oven dicht in de buurt van of boven een warmtebron wordt geïnstalleerd, kan deze beschadigd raken en komt de garantie te vervallen.

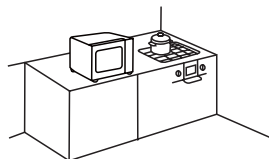

Het toegankelijke oppervlak kan
heet worden tijdens gebruik.

GEBRUIKSAANWIJZINGEN

VÓÓR HET EERSTE GEBRUIK

Het is normaal dat de oven bij het eerste gebruik een onaangenaam luchtje afgeeft.

Deze paragraaf beschrijft wat u moet doen voordat u uw magnetron voor de eerste keer gebruikt om voedsel te bereiden. Lees eerst de paragraaf "**BELANGRIJKE VEILIGHEIDSIN-STRUCTIES**" op pagina 3.

Voordat u uw nieuwe apparaat kunt gebruiken, dient u eerst het draaiplateau correct op zijn plek te plaatsen. Ook dienen de kookruimte en accessoires te worden gereinigd.



OPMERKING

- Gebruik het apparaat nooit zonder het draaiplateau.
- Zorg ervoor dat deze goed past. Het draaiplateau kan rechtsom of linksom draaien.

BEDIENING

BEDIENINGSPANEEL EN FUNCTIES

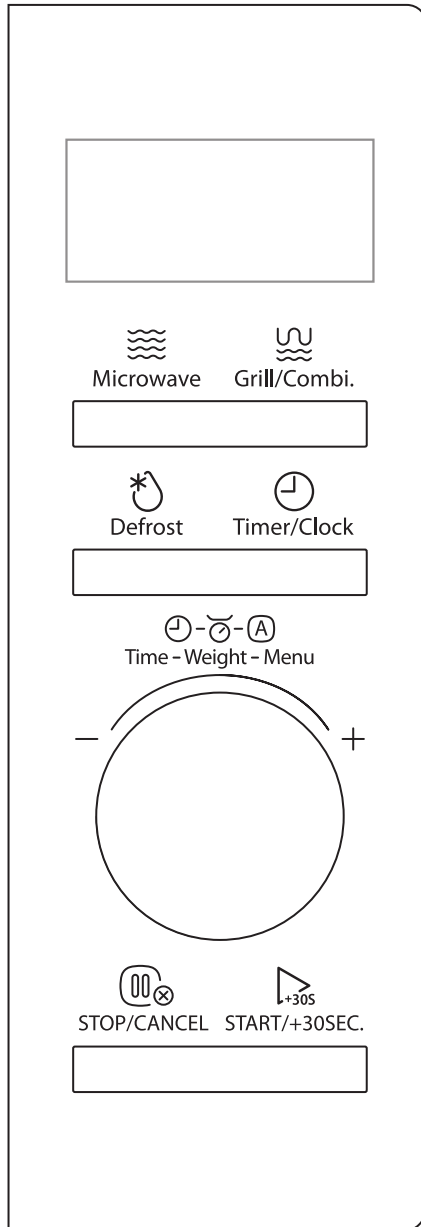

1. DE KLOK INSTELLEN

a Druk tweemaal op  Timer/Clock, "00:00" wordt weergegeven.



b Draai aan de knop om de uren in te stellen.

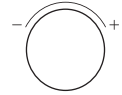

c Druk op  Timer/Clock of  START/+30SEC. om de uurcijfers te bevestigen.



of



d Draai aan de knop om de minuten in te stellen.

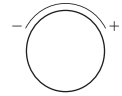

e Druk op  Timer/Clock of  START/+30SEC. om te bevestigen. De klok is ingesteld.



of



OPMERKING

- De klok is een 24-uurs display. Als de klok niet is ingesteld, werkt deze niet als u hem inschakelt.
- Om de klok opnieuw in te stellen, herhaalt u stappen a tot e.

2. DE KOOKWEKKER INSTELLEN

a Druk eenmaal op  Timer/Clock, "00:00" wordt weergegeven.



b Draai de knop om de gewenste tijd in te stellen. De maximale tijdswaarde is "95:00".

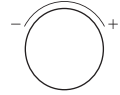

c Druk op  START/+30SEC, om te bevestigen. De timer begint af te tellen.



OPMERKING

- De kookwekker werkt als een timer.
- Een ander programma kan niet worden ingesteld tijdens de kookwekker.

3. KOKEN MET DE MAGNETRON

Er zijn 5 beschikbare vermogensniveaus.

NIVEAU	VERMOGEN	DISPLAY
1	100%	P100
2	80%	P80
3	50%	P50
4	30%	P30
5	10%	P10

- a** Druk herhaaldelijk op  Microwave om het vermogensniveau te kiezen.



- of** Druk eenmaal op  Microwave en draai aan de knop om het vermogensniveau in te stellen.



De 5 vermogensniveaus zijn beschikbaar.

- b** Druk op  START/+30SEC. om het vermogensniveau te bevestigen.



- c** Draai aan de knop om de kooktijd in te stellen, de maximale tijds waarde is "95:00".

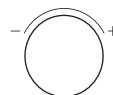

- d** Druk op  START/+30SEC. om te beginnen met koken.



4. KOKEN MET DE GRILL

- a** Druk eenmaal op  Grill/Combi., "G-1" wordt weergegeven.



- b** Druk op  START/+30SEC. om de modus te bevestigen.



- c** Draai aan de knop om de kooktijd in te stellen, de maximale tijds waarde is "95:00".

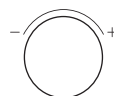

d Druk op  **START/+30SEC.** om te beginnen met koken.



OPMERKING • De zoemer klinkt om u eraan te herinneren het voedsel om te draaien tijdens het koken.
Als u niets doet, zal de oven gewoon blijven werken.

5. KOKEN MET DE COMBINATIEFUNCTIE

a Druk herhaaldelijk op  Grill/Combi. om de gewenste kookmodus te kiezen. "C-1, C-2" zijn beschikbaar.



of
Druk eenmaal op  Grill/Combi. en draai aan de knop om de kookmodus te kiezen.



b Druk op  **START/+30SEC.** om de modus te bevestigen.



c Draai aan de knop om de kooktijd in te stellen, de maximale tijdswaarde is "95:00".

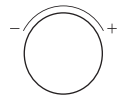

d Druk op  **START/+30SEC.** om te beginnen met koken.



COMBINATIEKOOKSCHEMA

FUNCTIE	DISPLAY	MAGNETRONVERMOGEN	GRILLVERMOGEN
Combinatie 1	C-1	55%	45%
Combinatie 2	C-2	36%	64%

6. ONTDOOIEN OP TIJD

- a** Druk tweemaal op  Defrost, "dEF2" wordt weergegeven.



- b** Draai aan de knop om de gewenste ontdooitijd in te stellen, de maximale tijdwaarde is "95:00".

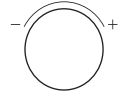

- c** Druk op  START/+30SEC. om te beginnen met ontdooien.



OPMERKING

- De zoemer klinkt om u eraan te herinneren het voedsel tijdens het ontdooien om te keren.
- Als u niets doet, zal de oven gewoon blijven werken.
- Het ontdooivermogen is P30 en kan niet worden aangepast.

7. ONTDOOIEN OP GEWICHT

- a** Druk eenmaal op  Defrost, "dEF1" wordt weergegeven.



- b** Draai aan de knop om het gewicht van het voedsel in te stellen. Het bereik van het gewicht is 100 g tot 2000 g.

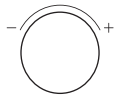

- c** Druk op  START/+30SEC. om te beginnen met ontdooien.



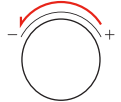

8. SNEL KOKEN

a Draai de knop naar links om een kooktijd op 100% vermogen in te stellen.

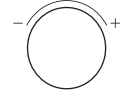

b Blijf aan de knop draaien om de kooktijd aan te passen, de maximale tijdswaarde is "95:00".



c Druk op  om te beginnen met koken.



a Druk op  om voedsel gedurende 30 seconden op een vermogensniveau van 100% te koken. Met elke druk op dezelfde toets wordt het 30 seconden verlengd en de maximale tijdswaarde is "95:00".



9. KOKEN MET MEERDERE FASEN

Voorbeeld: Als u het voedsel 5 minuten lang wilt ontdooien en vervolgens 7 minuten lang op 80% magnetronvermogen wilt koken.

a Druk tweemaal op  Defrost, "dEF2" wordt weergegeven.



b Draai aan de knop om de gewenste ontdooitijd in te stellen op 5 minuten.



c Druk herhaaldelijk op  Microwave totdat "P80" wordt weergegeven.



d Druk op  om het vermogensniveau te bevestigen.



e Draai de knop om de kooktijd in te stellen op 7 minuten.

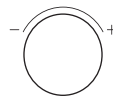

f Druk op  START/+30SEC. om te beginnen met koken.



OPMERKING

- Bij meergefasig koken kunnen twee kookfasen worden ingesteld.
- Als u de ontdooifunctie instelt, werkt deze automatisch in de eerste fase.
- De kookwekker en het automatische menu kunnen niet worden ingesteld als een van de meerdere fasen.

10. AUTOMATISCH MENU

a Draai in de stand-by-modus één keer aan de knop naar rechts en vervolgens wordt "A-1" weergegeven.

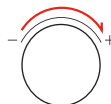

b Blijf aan de knop draaien om het gewenste menu te kiezen. De 8 automatische menu's zijn beschikbaar.



c Druk op  START/+30SEC. om te bevestigen.



d Draai aan de knop om het gewicht van het voedsel in te stellen.



e Druk op  START/+30SEC. om te beginnen met koken.



OVERZICHT VAN HET AUTOMATISCHE MENU

MENU	GEWICHT/ HOEVEELHEID	DISPLAY	VERMOGENSNIVEAU
A-1 Automatisch opwarmen	200 g	200 g	P100
	400 g	400 g	
	600 g	600 g	
A-2 Groente	200 g	200 g	P100
	300 g	300 g	
	400 g	400 g	
A-3 Vis	250 g	250 g	P80
	350 g	350 g	
	450 g	450 g	
A-4 Vlees	250 g	250 g	P100
	350 g	350 g	
	450 g	450 g	
A-5 Pasta	50 g (met 450 g koud water)	50 g	P80
	100 g (met 800 g koud water)	100 g	
A-6 Aardappelen	200 g	200 g	P100
	400 g	400 g	
	600 g	600 g	
A-7 Bevroren pizza	200 g	200 g	P100/Grill
	400 g	400 g	
A-8 Soep	200 ml	200	P80
	400 ml	400	



11. KINDERSLOTFUNCTIE

U kunt deze functie gebruiken om te voorkomen dat kinderen per ongeluk de oven inschakelen.

- a** Om het slot te activeren:  Houd in de stand-bymodus  gedurende drie seconden ingedrukt.



Er klinkt een pieptoon en het vergrendelde pictogram wordt weergegeven.

- b** Om het slot te deactiveren:  Houd in de vergrendelde toestand  drie seconden ingedrukt.



Er klinkt een pieptoon.

12. CONTROLEFUNCTIE

- a** Druk op  Timer/Clock wanneer de oven aan het koken is. De huidige tijd wordt gedurende drie seconden weergegeven op het display.



- b** Druk in de kookstand van de magnetron op  Microwave om te informeren naar het vermogensniveau. Het zal drie seconden worden weergegeven.



- c** Druk in de grill- en combinatietoestand op  Grill/Combi. om te informeren naar de kookmodus. Het zal drie seconden worden weergegeven.



REINIGING

Als u het apparaat goed onderhoudt en schoonmaakt, blijft deze er lang mooi uitzien en blijft het ook lang volledig functioneren. Hoe u uw apparaat op de juiste manier onderhoudt en reinigt, leggen wij u hier uit.



WAAR- SCHUWING

- Gekrast glas in de deur van het apparaat kan een barst vormen. Gebruik geen glasschraper, scherpe of schurende schoonmaak- of afwasmiddelen.
- Het oppervlak van het apparaat kan beschadigd raken als het niet goed wordt schoongemaakt. Er kan microgolvenenergie ontsnappen. Maak het apparaat regelmatig schoon en verwijder eventuele etensresten onmiddellijk.
- Dompel het apparaat niet onder in water en reinig het niet onder stromend water.

Reinigingsmiddel

Om ervoor te zorgen dat de verschillende oppervlakken niet beschadigd raken door het gebruik van het verkeerde reinigingsmiddel, dient u rekening te houden met onderstaande informatie. Was nieuwe sponsdoekjes grondig vóór gebruik.

Niet gebruiken:



Agressieve of schurende
schoonmaakmiddelen



Metaal- of glasschrapers
om de deurpanelen
schoon te maken



Metaal- of glasschrapers
om de deurafdichting
schoon te maken



Harde schuursponsjes



Reinigingsmiddelen met
een hoog alcoholgehalte

VOORZIJDEN VAN APPARAAT

Heet sopje:

Reinigen met een vaatdoek en vervolgens drogen met een zachte doek.

Gebruik voor het schoonmaken geen metaal- of glasschrapers.

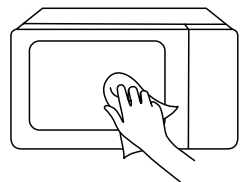

REINIGING

VOORZIJDEN VAN APPARAAT

Heet sopje:

Reinigen met een vaatdoek en vervolgens drogen met een zachte doek. Spatten en kalkaanslag, vet, zetmeel en albumine onmiddellijk verwijderen. Onder deze vlekken of spatten kan corrosie ontstaan. Gebruik voor het schoonmaken geen glasreinigers, metaal- of glasschrapers.

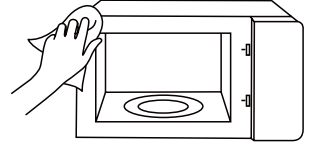

RUIMTE IN HET APPARAAT

Heet sopje of een azijnoplossing:

Reinigen met een vaatdoek en vervolgens drogen met een zachte doek. Gebruik geen ovenspray, andere agressieve ovenreinigers of schurende materialen. Ook schuursponsjes, ruwe sponzen en pannenreinigers zijn ongeschikt. Deze voorwerpen bekrassen het oppervlak. Laat de binnenoppervlakken volledig drogen.

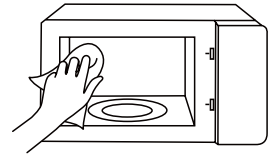

IN DE KOOKRUIMTE

Vochtige doek:

Er mag via de aandrijving van het draaiplateau geen water in het apparaat terechtkomen. Droog de aandrijving van het draaiplateau met een doek.

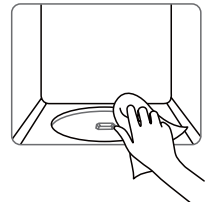

DRAAIPLATEAU- EN ROLRINGUITSPARING

Heet sopje:

Bij het terugplaatsen van het draaiplateau moet deze goed in de uitsparing passen.

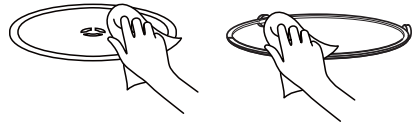

DEURPANEEL

Glasreiniger:

Reinigen met een vaatdoek. Gebruik geen glasschrapers.

PROBLEEMOPLOSSING

Controleer uw probleem aan de hand van de onderstaande tabel en probeer de oplossingen voor elk probleem. Als de magnetron nog steeds niet goed werkt, neem dan contact op met het dichtstbijzijnde geautoriseerde servicecentrum.

PROBLEEM	MOGELIJKE OORZAAK	MOGELIJKE OPLOSSING
De oven start niet	<ul style="list-style-type: none"> a. Het netsnoer van de oven is niet aangesloten. b. Deur is open. c. Verkeerde werking ingesteld. 	<ul style="list-style-type: none"> a. Aansluiten op het stopcontact. b. Sluit de deur en probeer het opnieuw. c. Controleer de instructies
Vlambogen of vonken	<ul style="list-style-type: none"> a. Er waren materialen gebruikt die in de magnetron moeten worden vermeden. b. De oven werd gebruikt wanneer deze leeg was. c. Gemorste voedselresten in de ovenruimte. 	<ul style="list-style-type: none"> a. Gebruik uitsluitend magnetronbestendig kookgerei. b. Laat de oven niet leeg werken. c. Reinig de ovenruimte met een zachte, vochtige doek.
Ongelijkmatig gekookt voedsel	<ul style="list-style-type: none"> a. Er waren materialen gebruikt die in de magnetron moeten worden vermeden. b. Voedsel is niet volledig ontdooid. c. Kooktijd, vermogensniveau is niet geschikt. d. Voedsel niet omgedraaid of geroerd. 	<ul style="list-style-type: none"> a. Gebruik uitsluitend magnetronbestendig kookgerei. b. Voedsel volledig ontdooid. c. Gebruik de juiste kooktijd en vermogensniveau. d. Roer of draai voedsel om.
Te gaar voedsel	Kooktijd, vermogensniveau is niet geschikt.	Gebruik de juiste kooktijd en vermogensniveau.
Voedsel niet gaar	<ul style="list-style-type: none"> a. Er waren materialen gebruikt die in de magnetron moeten worden vermeden. b. Voedsel is niet volledig ontdooid. c. De ventilatieopeningen van de oven worden geblokkeerd. d. Kooktijd, vermogensniveau is niet geschikt. 	<ul style="list-style-type: none"> a. Gebruik uitsluitend magnetronbestendig kookgerei. b. Voedsel volledig ontdooid. c. Controleer of de ventilatieopeningen van de oven niet geblokkeerd worden. d. Gebruik de juiste kooktijd en vermogensniveau
Ontoereikend ontdooiden	<ul style="list-style-type: none"> a. Er waren materialen gebruikt die in de magnetron moeten worden vermeden. b. Kooktijd, vermogensniveau is niet geschikt. c. Voedsel niet omgedraaid of geroerd. 	<ul style="list-style-type: none"> a. Gebruik uitsluitend magnetronbestendig kookgerei. b. Gebruik de juiste kooktijd en vermogensniveau. c. Roer of draai voedsel om.



Volgens de AEEA-richtlijn (afgedankte elektrische en elektronische apparaten) moet AEEA afzonderlijk worden ingezameld en verwerkt. Als u dit product op enig moment in de toekomst moet afvoeren, gooi dit product dan NIET weg met het huishoudelijk afval. Lever dit product in op beschikbare AEEA-inzamelpunten.

#DetailsMatter

BRUKSANVISNING

MIKROVÅGSUGN

MW3-AG20PE(BK) / MW3-AG20PE(WH)

Läs igenom denna bruksanvisning innan du använder den.

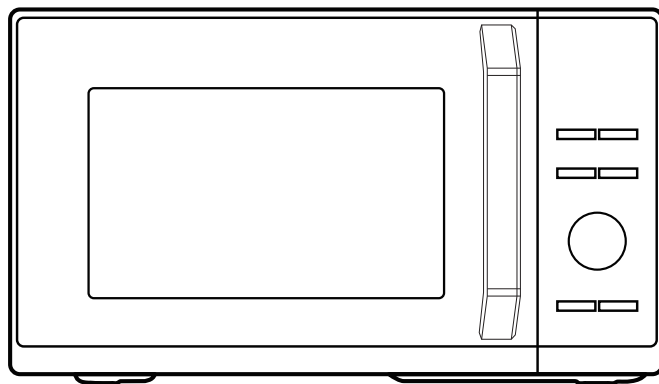

TOSHIBA

INNEHÅLL

PRODUKTSÄKERHET

Försiktighetsåtgärder för att undvika möjlig exponering för allt för hög mikrovågsenergi.....	SV-01
Viktiga säkerhetsföreskrifter.....	SV-03
För att minska risken för skador på personer vid jordad installation	SV-08
Rengöring	SV-10
Redskap	SV-11
Material som du kan använda i mikrovågsugn	SV-12
Material inte kan användas i mikrovågsugn	SV-14

PRODUKTINSTÄLLNING

Ställa in din ugn	SV-15
-------------------------	-------

BRUKSANVISNING

Innan användning för första gången	SV-19
Drift.....	SV-20
1. Ställa in klockan	SV-21
2. Ställa in kökstimern	SV-22
3. Tillagning i mikrovågsugnen	SV-22
4. Grillning	SV-23
5. Kombinerad tillagning	SV-24
6. Tidsbaserad upptining	SV-25
7. Viktbaserad upptining	SV-25
8. Snabb tillagning	SV-26

9. Tillagning I flera steg	SV-26
10. Automatisk meny.....	SV-27
11. Barnlås	SV-29
12. Informationsfunktion	SV-29
Rengöring	SV-30

UNDERHÅLL

Felsökning.....	SV-32
-----------------	-------



NOTERA

LÄS, FÖRSTÅ OCH FÖLJ DESSA INSTRUKTIONER
INNAN PRODUKTEN ANVÄNDS. SE TILL ATT SPARA
DENNA BOKLISTA FÖR FRAMTIDA REFERENS.

PRODUKTSÄKERHET

FÖRSIKTIGHETSÅTGÄRDER FÖR ATT UNDVIKA MÖJLIG EXPONERING FÖR ALLT FÖR HÖG MIKROVÅGSENERGI

(a). Försök inte använda denna ugn med luckan öppen eftersom det kan resultera i skadlig exponering för mikrovågsenergi. Det är viktigt att inte bryta eller manipulera med säkerhetsparrarna.

(b). Placera inga föremål mellan ugnens framsida och luckan och låt inte smuts eller rester av rengöringsmedel samlas på tätningsytor.

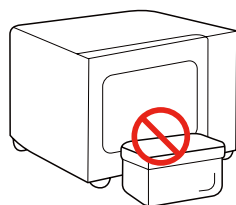

(c). **WARNING:** Om luckan eller luckans tätningar skadas får ugnen inte användas förrän den har reparerats av en kompetent person.

TILLÄGG

Hålls apparaten inte i gott skick kan dess yta försämrats och påverka apparatens livslängd och leda till en farlig situation.

SPECIFIKATIONER

MODELL	MW3-AG20PE(BK) / MW3-AG20PE(WH)
MÄRKSPÄNNING /FREKVENNS	230 V~ 50 Hz
NOMINELL INGÅNGSEFFEKT (MIKROVÅG)	1270 W
NOMINELL UTGÅNGSEFFEKT (MIKROVÅG)	800 W
NOMINELL INGÅNGSEFFEKT (GRILL)	1000 W

ENERGIFÖRBRUKNING

Produktinformation om strömförbrukning och maximal tid för att nå tillämpligt lågeffektläge.

Standby-läge	0.8 W
Den maximala tid som krävs för att mikrovågsugnen automatiskt ska nå det tillämpliga lågeffektläget eller tillståndet.	20 minuter



NOTERA

Alla bilder i denna bruksanvisning är endast för illustrativa ändamål; de kan skilja sig något från den köpta utrustningen, se den faktiska produkten.

VIKTIGA SÄKERHETSINSTRUKTIONER



VARNING

För att minska risken för brand, elektriska stötar, personskador eller exponering för överdriven energi från mikrovågsugnen när du använder apparaten, ska du följa grundläggande försiktighetsåtgärder, inklusive följande:



Läs och följ det specifika: **"FÖRSIKTIGHETSÅTGÄRDER FÖR ATT UNDVIKA MÖJLIG EXPONERING FÖR ALLT FÖR HÖG MIKROVÅGSENERG"**.



Denna apparat kan användas av barn från 8 år och uppåt och personer med nedsatt fysisk, sensorisk eller mental förmåga eller bristande erfarenhet och kunskap om de har fått övervakning eller instruktioner om hur man använder apparaten på ett säkert sätt och förstår farorna inblandade. Barn får inte leka med apparaten. Rengöring

och användarunderhåll får inte utföras av barn utan tillsyn.



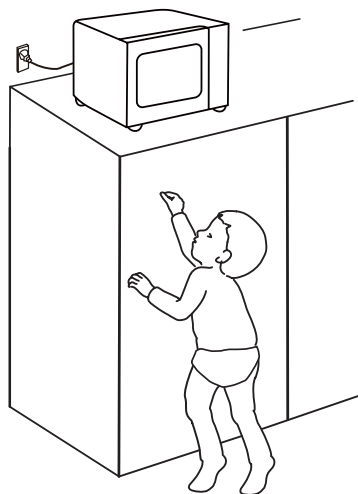

Förvara apparaten och dess sladd utom räckhåll för barn under 8 år.





VIKTIGA SÄKERHETSINSTRUKTIONER

 Om nätsladden är skadad måste den bytas ut av tillverkaren, dess servicerepresentant eller liknande kvalificerade personer för att undvika fara.

 **VARNING:** Se till att apparaten är avstängd innan du byter lampa för att undvika risken för elektriska stötar.

 **VARNING:** Det är farligt för någon annan än en kompetent person att utföra service eller reparationer som innebär att ett skydd som skyddar mot exponering för mikro vågsenergi tas bort.

 **VARNING:** Vätskor och andra livsmedel får inte värmas i förslutna behållare eftersom de riskerar att explodera.

 Vid uppvärmning av mat i plast- eller pappersbehållare, håll ett öga på ugnen på grund av risken för antändning.



 Använd endast redskap som är lämpliga för användning i mikro vågsugnar.

 Om rök avges, stäng av eller koppla ur apparaten och håll dörren stängd för att kväva eventuella lågor.

 Uppvärmning av drycker i mikro vågsugn kan resultera i fördröjd eruptiv kokning. Därför ska försiktighet iakttas vid hantering av behållaren.

 Innehållet i nappflaskor och barnmatsburkar ska röras om eller skakas och temperaturen kontrolleras

VIKTIGA SÄKERHETSINSTRUKTIONER

före konsumtion för att undvika brännskador.

 **WARNING:** När apparaten används i kombinationsläge, bör barn endast använda ugnen under uppsikt av vuxen på grund av de genererade temperaturerna.

 Underlåtenhet att hålla ugnen i rent skick kan leda till försämring av ytan som kan påverka apparatens livslängd negativt och eventuellt resultera i en farlig situation.

 Använd endast den temperaturgivare som rekommenderas för denna ugn. (för ugnar försedda med en möjlighet att använda en sond för temperaturavkänning.)

 Mikrovägsugnen ska användas med den dekorativa luckan öppen. (för ugnar med dekorativ lucka.)

 Denna apparat är avsedd att användas i hushåll och liknande applikationer som:

1. personalkök i butiker, kontor och andra arbetsmiljöer;
2. av kunder på hotell, motell och andra bostadsmiljöer;
3. gårdshus;
4. miljöer av typ bed and breakfast.

 Mikrovägsugnen är avsedd för uppvärmning av mat och dryck. Torkning av mat eller kläder och uppvärmning av värmande kuddar, tofflor, svampar, fuktig trasa och liknande kan leda till risk för skador, antändning eller brand.

VIKTIGA SÄKERHETSINSTRUKTIONER

 Apparaten är avsedd att användas fristående.

 Den bakre ytan på apparater ska placeras mot en vägg.

 Temperaturen på tillgängliga ytor kan vara hög när apparaten är igång.

 Ugnen bör rengöras regelbundet och eventuella matrester avlägsnas. Håll vågledarområdet rent. Använd en mjuk fuktig trasa för att rengöra den när det finns matrester på vågledarområdet eller hålrummet. Underlåtenhet att rengöra matrester kan orsaka ofarliga gnistor eller viss rök i mikrovågsugnen, missfärgning av hålrummet kan också uppstå.

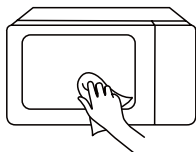

 Ägg i skalet och hela hårdkokta ägg bör inte värmas i mikrovågsugnar eftersom de kan explodera, även efter att uppvärmningen av mikrovågsugnen har avslutats.

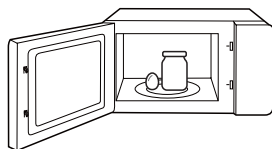



 Mikrovågsugnen får inte placeras i ett skåp om den inte har testats i ett skåp.

 Metalliska behållare för mat och dryck är inte tillåtna under tillagning i mikrovågsugn.

 Apparaten får inte rengöras med en ångtvätt.

VIKTIGA SÄKERHETSINSTRUKTIONER

 Apparaterna är inte avsedda att drivas med hjälp av en extern timer eller separat fjärrkontrollsystem.

 Apparaten får inte installeras bakom en dekorativ lucka för att undvika överhettning. (Detta gäller inte apparater med dekorativ lucka.)

LÄS NOGA OCH BEVARA FÖR
FRAMTIDA REFERENS

FÖR ATT MINSKA RISKEN FÖR SKADA PÅ PERSONER SOM JORDAD INSTALLATION

Denna apparat måste vara jordad. I händelse av en elektrisk kortslutning minskar jordning risken för elektriska stötar genom att tillhandahålla en flyktledning för den elektriska strömmen. Denna apparat är utrustad med en sladd som har en jordkabel med en jordad kontakt. Kontakten ska anslutas till ett uttag som är korrekt installerat och jordat.

WARNING - Felaktig användning av jordning kan leda till risk för elektriska stötar. Rådfråga en kvalificerad elektriker eller serviceman om instruktionerna för jordning inte förstås helt eller om det råder tvivel om huruvida apparaten är korrekt jordad. Blir det nödvändigt att använda en förlängningssladd, använd endast en 3-tråds förlängningssladd.



FARA

Risk för elektriska stötar:
Att röra några av de inre komponenterna kan orsaka allvarliga personskador eller dödsfall. Ta inte isär denna apparat.

FÖR ATT MINSKA RISKEN FÖR SKADA PÅ PERSONER SOM JORDAD INSTALLATION



VARNING

Risk för elektriska stötar:

Felaktig användning av jordning kan resultera i elektriska stötar. Anslut inte till ett uttag förrän apparaten är korrekt installerad och jordad.

1. En kort strömsladd medföljer för att minska riskerna för att bli intrasslad in i eller snubbla över en längre sladd.
2. Om en lång sladd eller förlängningsladd används:
 - (1). Den markerade elektriska märkningen för sladdsatsen eller förlängningsladden bör vara minst lika hög som apparatens elektriska märkvärde.
 - (2). Förlängningsladden måste vara en 3-trådig jordad sladd.
 - (3). Den längre sladden ska placeras så att den inte draperas över bänkskivan eller bordsskivan där den kan dras i av barn eller snubbla över den oavsiktligt.

RENGÖRING

Se till att koppla bort apparaten från strömförsörjningen.

1. Rengör ugnens hålrum efter användning med en lätt fuktad trasa.
2. Rengör tillbehören på vanligt sätt i tvålatten.
3. Luckans karm och tätningen och angränsande delar måste rengöras noggrant med en fuktig trasa när de är smutsiga.
4. Använd inte hårda slipande rengöringsmedel eller vassa metallskrapor för att rengöra ugnsluckans glas eftersom de kan repa ytan, vilket kan resultera i att glaset splittras.
5. Rengöringstips---För enklare rengöring av hålrummets väggar som den tillagade maten kan komma i kontakt med: Lägg en halv citron i en skål, tillsätt 300 ml (1/2 pint) vatten och värm på 100 % mikrovågseffekt i 10 minuter. Torka av ugnen med en mjuk, torr trasa.

REDSKAP



VARNING

Risk för personskador:

Det är farligt för någon annan än en kompetent person att utföra service eller reparationer som innebär att ett skydd som skyddar mot exponering för mikrovågsenergi tas bort. Se instruktionerna på "**Material du kan använda i mikrovågsugn**" eller "**Material som inte kan användas i mikrovågsugn**".

Det kan finnas vissa icke-metalliska redskap som inte är säkra att använda för mikrovågsugn. Är du osäker kan du testa det aktuella redskapet enligt proceduren nedan.

Test av redskap:

1. Fyll en mikrovågssäker behållare med 1 kopp kallt vatten (250 ml) tillsammans med redskapet i fråga.
2. Koka på maximal effekt i 1 min.
3. Känn av noggrant på redskapet. Om det tomma redskapet är varmt, använd det inte för tillagning i mikrovågsugn.
4. Överskrid inte 1 min tillagningstid.

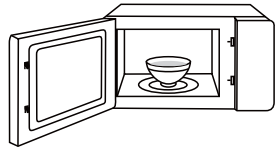





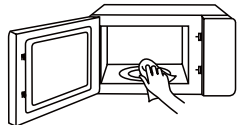











NOTERA

HÅLL HÅLRUMMET OCH
VÅGLEDAROMRÅDET RENT



MATERIAL SOM DU KAN ANVÄNDA I MIKROVÅGSUGN

REDSKAP	ANMÄRKNINGAR	
 Brynfat	Följ tillverkarens instruktioner. Botten på brynfatet måste vara minst 5 mm ovanför tallriken. Felaktig användning kan göra att tallriken går sönder.	
 Matservis	Endast mikrovågssäker. Följ tillverkarens instruktioner. Använd inte spruckna eller kantstötta kärl.	
 Glasburkar	Ta alltid av locket. Använd endast för att värma mat tills den är precis varm. De flesta glasburkar är inte värmebeständiga och kan gå sönder.	
 Glas	Endast värmebeständigt ugnsglas. Se till att det inte finns någon metallbeklädnad. Använd inte spruckna eller kantstötta kärl.	
 Ugnsmatlagningspåsar	Följ tillverkarens instruktioner. Stäng inte med metallband. Gör skårar så att ånga kan komma ut.	
 Papperstallrikar och koppar	Använd endast för kortvarig tillagning/uppvärmning. Lämna inte ugnen utan uppsikt när du lagar mat.	
 Pappershandukar	Används för att täcka maten för att värma upp och absorbera fett. Använd endast under övervakning för en kortvarig matlagning.	
 Bakplåtspapper	Använd som ett överdrag för att förhindra stänk eller ett omslag för ångning.	

MATERIAL SOM DU KAN ANVÄNDA I MIKROVÅGSUGN

REDSKAP

ANMÄRKNINGAR



Plast

Endast mikrovågssäker. Följ tillverkarens instruktioner. Bör märkas "Mikrovågssäker". Vissa plastbehållare mjuknar, allt eftersom maten blir varm. "Kokningspåsar" och tättslutna plastpåsar ska skäras, genomborras eller ventileras enligt anvisningar på förpackningen.



Plastfolie

Endast mikrovågssäker. Används för att täcka maten under tillagningen för att behålla fukten. Låt inte plastfolie komma i kontakt med maten.



Termometrar

Endast mikrovågssäker (kött- och godistermometrar).

















Vaxpapper

Använd som skydd för att förhindra stänk och behålla fukt.



MATERIAL SOM INTE KAN ANVÄNDAS I MIKROVÅGSUGN

Redskap	ANMÄRKNINGAR
 <p>Aluminiumbricka</p>	Kan orsaka ljusbågsbildning. Överför maten i en mikrovågssäker skål. 
 <p>Matkartong med metallhandtag</p>	Kan orsaka ljusbågsbildning. Överför maten i en mikrovågssäker skål. 
 <p>Metall eller metall trimmade redskap</p>	Metall skyddar maten från mikrovågsenergi. Metallbeklädnad kan orsaka ljusbågsbildning. 
 <p>Påsförslutare i metall</p>	Kan orsaka ljusbågar och brand i ugnen. 
 <p>Papperspåsar</p>	Kan orsaka brand i ugnen. 
 <p>Plastskum</p>	Plastskum kan smälta eller förorena vätskan inuti när det utsätts för hög temperatur. 
 <p>Trä</p>	Trä kommer att torka ut när det används i mikrovågsugnen och kan spricka. 

PRODUKTINSTÄLLNING

INSTÄLLNING AV DIN UGN

NAMN PÅ MIKROVÅGSUGNENS DELAR OCH TILLBEHÖR

Ta bort ugnen och allt material från kartongen och ugnens hålrum.

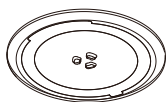

Glasbricka

(Kan användas i alla funktioner)

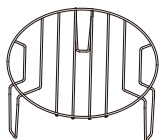

Grillställ (Kan inte användas i mikrovågsfunktion och måste placeras på glasbrickan)

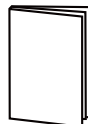

Bruksanvisning

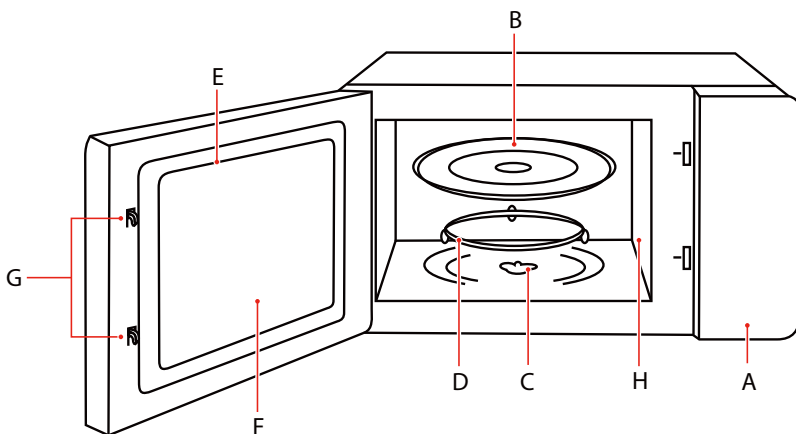

A. Kontrollpanel

B. Glasbricka

C. Roterande tallriks axel

D. Tallriksens roterande ring

E. Luckmontering

F. Observationsfönster

G. Säkerhetssystem

H. Vågledarskydd



NOTERA

Alla bilder i denna bruksanvisning är endast för illustrativa ändamål; de kan skilja sig något från den köpta utrustningen, se den faktiska produkten.

INSTÄLLNING AV DIN UGN

INSTALLATION AV DEN ROTERANDE TALLRIKEN

Rengöring av ugn och sätta på tallriken på plats.

För nya installationer, se till att all förpackning och frakttejp har tagits bort från tallrikens axel. Innan du använder apparaten för att laga mat första gången måste du sätta tallriken på rätt plats. Du måste rengöra ugn och tillbehör.

Så här sätter du tallriken på plats:

1. Placera tallrikens ring ③ i urtaget i ugnen.
2. Placera glasbrickan ① på tallrikens ringanordning ③. Montera de upphöjda, böjda linjerna i mitten av glasbrickans botten mellan axelns tre ekrar. Se till att glasbrickan ① hakar fast i tallrikens axel ② i mitten av utrymmet för tillagning. Rullarna på axeln ska passa inuti tallrikens bottenkant.

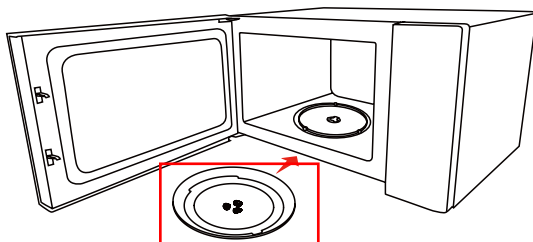
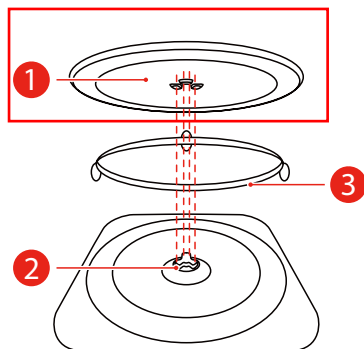

NOTERA

- Använd aldrig apparaten utan den roterande tallriken. Se till att den är ordentligt inkopplad. Den roterande tallriken kan vridas medurs eller moturs.
- Placera aldrig glasbrickan upp och ner. Glasbrickan ska aldrig begränsas.
- Både glasbrickan och den roterande tallriken måste alltid användas under tillagningen.
- All mat och behållare med mat placeras alltid på glasbrickan för tillagning.
- Begränsa aldrig tallrikens rörelse.
- Om glasbrickan eller tallrikens ring spricker eller går sönder, kontakta närmaste auktoriserade servicecenter.

INSTÄLLNING AV DIN UGN

INSTALLATION AV BÄNKSKIVA

Ta bort allt förpackningsmaterial och alla tillbehör. Undersök ugnen för eventuella skador som bucklor eller trasig lucka. Installera inte om ugnen är skadad.

Skåp: Ta bort all skyddsfilm som finns på mikrovågsugnsens skåpyta. Ta inte bort vågledarhöljet som är fäst i ugnens hålrum för att skydda magnetronen.

INSTALLATION

- Välj en plan yta som ger tillräckligt med öppet utrymme för inlopps- och/eller utloppsventilerna.
 - Minsta installationshöjd är 85 cm.
 - Den bakre ytan på apparaten ska placeras mot en vägg. Lämna ett fritt utrymme på minst 30 cm ovanför ugnen. Ett minsta avstånd på 20 cm krävs mellan ugnen och eventuella intilliggande väggar.
 - Ta inte bort benen från botten av ugnen.
 - Blockering av inlopps- och/eller utloppsöppningar kan skada ugnen.
 - Placera ugnen så långt bort från radio och TV som möjligt.
Användning av mikrovågsugnen kan orsaka störningar på din radio- eller tv-mottagning.

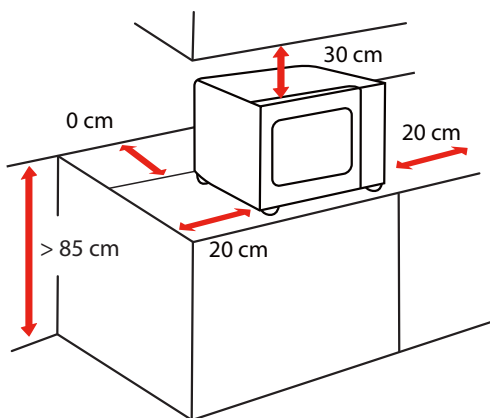

SIDA	AVSTÅND (tum/cm)
Topp	30 cm
Vänster	20 cm
Höger	20 cm
Baksidan	0 cm
Främre	Öppen

INSTÄLLNING AV DIN UGN

2. Anslut ugnen till ett vanligt hushållsuttag. Se till att spänningen och frekvensen är samma som spänningen och frekvensen på märketiketten.



- Installera inte ugnen över en spishäll eller annan värmealstrande apparat. Om den installeras nära eller över en värmekälla kan ugnen skadas och garantin upphöra att gälla.

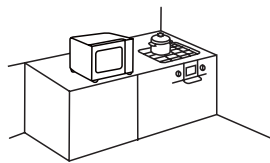

Den tillgängliga ytan kan bli varm under drift.

BRUKSANVISNING

INNAN ANVÄNDNING FÖR FÖRSTA GÅNGEN

Apparaten kan avge obehagliga lukter när den används för första gången.

Det här avsnittet berättar vad du behöver göra innan du använder mikrovågsugnen för att laga mat första gången. Läs avsnittet med titeln "**VIKTIGA SÄKERHETSINSTRUKTIONER**" i förväg på sidan 3.

Innan du kan använda din nya apparat måste du sätta tallriken på rätt plats. Du måste också rengöra ugn och tillbehör.



NOTERA

- Använd aldrig apparaten utan den roterande tallriken.
- Se till att den är ordentligt inkopplad. Den roterande tallriken kan vridas medurs eller moturs.

DRIFT

KONTROLLPANELEN OCH FUNKTIONER

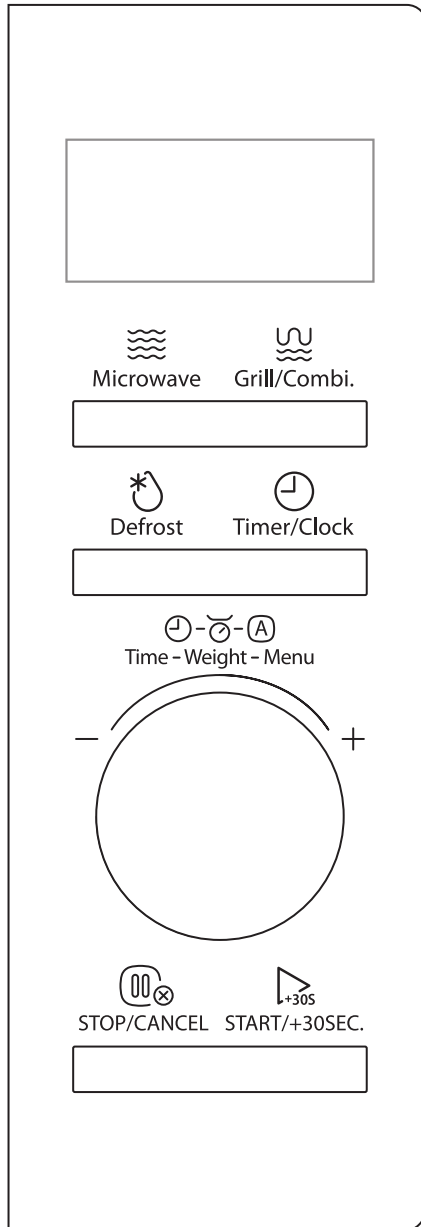

1. STÄLLA IN KLOCKAN

a Tryck på  Timer/Clock två gånger, så visas "00:00".



b Vrid på ratten för att ställa in timsiffrorna.

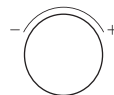

c Tryck på  Timer/Clock eller  START/+30SEC. för att bekräfta timsiffrorna.



eller



d Vrid på ratten för att ställa in minutsiffrorna.

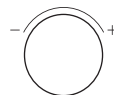

e Tryck på  Timer/Clock eller  START/+30SEC. för att bekräfta. Klockan har ställts in.



eller



- Klockan har 24-timmarsvisning. Om klockan inte är inställd fungerar den inte när den slås på.
- För att återställa klockan gör du om steg a till steg e.

2. STÄLLA IN KÖKSTIMERN

a Tryck på  Timer/Clock en gång, så visas "00:00".



b Vrid på ratten för att ställa in önskad tid.
Det högsta tidsvärdet är "95:00".



c Tryck på  START/+30SEC. för att bekräfta. Timern börjar räkna ner.



Obs

- Kökstimern är en timer.
- Inga andra program kan ställas in när kökstimern är igång.

3. TILLAGNING I MKROVÅGSUGNEN

Det finns fem effektnivåer.

NIVÅ	EFFEKT	VISNING
1	100 %	P100
2	80 %	P80
3	50 %	P50
4	30 %	P30
5	10 %	P10

- Tryck på  Microwave flera gånger för att välja effektnivå.
- a** eller



- Tryck på  Microwave en gång och vrid sedan ratten för att ställa in effektnivån.



De fem effektnivåerna är tillgängliga.

- b** Tryck på  START/+30SEC. för att bekräfta effektnivån.



- c** Vrid på ratten för att ställa in tillagningstiden. Det högsta tidsvärdet är "95:00".

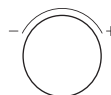

- d** Tryck på  START/+30SEC. för att starta tillagningen.



4. GRILLNING

- a** Tryck på  Grill/Combi. en gång, så visas "G-1".



- b** Tryck på  START/+30SEC. för att bekräfta läget.



- c** Vrid på ratten för att ställa in tillagningstiden. Det högsta tidsvärdet är "95:00".

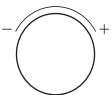

d Tryck på  START/+30SEC. för att starta tillagningen.



Obs

- Summern ljuder för att påminna dig om att vända på maten under tillagningen. Om ingen åtgärd vidtas fortsätter ugnen att vara i drift.

5. KOMBINERAD TILLAGNING

a Tryck på  Grill/Combi. flera gånger för att välja önskat tillagningsläge. "C-1, C-2" finns tillgängliga.



a eller
Tryck på  Grill/Combi. en gång och vrid sedan ratten för att välja tillagningsläge.



b Tryck på  START/+30SEC. för att bekräfta läget.

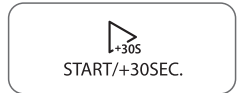

c Vrid på ratten för att ställa in tillagningstiden. Det högsta tidsvärdet är "95:00".

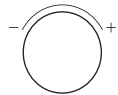

d Tryck på  START/+30SEC. för att starta tillagningen.



TABELL FÖR KOMBINERAD TILLAGNING

FUNKTION	VISNING	MIKROVÅGSEFFEKT	GRILLEFFEKT
Kombi. 1	C-1	55 %	45 %
Kombi. 2	C-2	36 %	64 %

6. TIDSBASERAD UPPTINING

a Tryck på  Defrost två gånger så visas "dEF2".



b Vrid på ratten för att ställa in önskad upptiningstid. Det högsta tidsvärdet är "95:00".

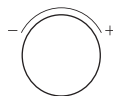

c Tryck på  START/+30SEC. för att starta upptiningen.



Obs

- Summern ljuder för att påminna dig om att vända på maten under upptiningen. Om ingen åtgärd vidtas fortsätter ugnen att vara i drift.
- Upptiningseffekten är P30 och den kan inte ändras.

7. VIKTBASERAD UPPTINING

a Tryck på  Defrost en gång, så visas "dEF1".



b Vrid på ratten för att ställa in matens vikt. Viktintervallet är 100 g till 2 000 g.



c Tryck på  START/+30SEC. för att starta upptiningen.



8. SNABB TILLAGNING

a Vrid ratten åt vänster för att ställa in en tillagningstid med 100 % effekt.

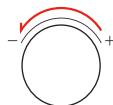

b Fortsätt att vrida ratten för att ställa in tillagningstiden. Det högsta tidsvärdet är "95:00".



c Tryck på  START/+30SEC. för att starta tillagningen.



a Tryck på  START/+30SEC. för att tillaga maten på 100 % effektnivå i 30 sekunder. Varje tryck på samma knapp ökar tiden med 30 sekunder och det högsta tidsvärdet är "95:00".



9. TILLAGNING I FLERA STEG

Exempel: Tina maten i fem minuter och tillaga sedan med 80 % mikrovågseffekt i sju minuter.

a Tryck på  Defrost två gånger, så visas "dEF2".



b Vrid på ratten för att ställa in önskad upptiningstid på fem minuter.



c Tryck på  Microwave flera gånger tills "P80" visas.



d Tryck på  START/+30SEC. för att bekräfta effektnivån.



e Vrid på ratten för att ställa in tillagningstiden på sju minuter.

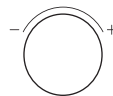

f Tryck på  START/+30SEC. för att starta tillagningen.



Obs

- Två tillagningssteg kan ställas in vid tillagning i flera steg.
- Om du ställer in upptinjningsfunktionen fungerar den automatiskt i det första steget.
- Kökstimern och den automatiska menyn kan inte ställas in under tillagning i flera steg.

10. AUTOMATISK MENY

a I standbyläge vrid du ratten åt höger en gång, så visas "A-1".

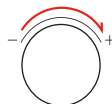

b Fortsätt att vrida ratten för att välja önskad meny. De åtta automatiska menyerna är tillgängliga.

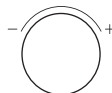

c Tryck på  START/+30SEC. för att bekräfta.



d Vrid på ratten för att ställa in matens vikt.



e Tryck på  START/+30SEC. för att starta tillagningen.



TABELL ÖVER AUTOMATISKA MENYER

Meny	VIKT/MÄNGD	VISNING	EFFEKTNIVÅ
A-1 Automatisk återuppvärmning	200 g 400 g 600 g	200 g 400 g 600 g	P100
A-2 Grönsaker	200 g 300 g 400 g	200 g 300 g 400 g	P100
A-3 Fisk	250 g 350 g 450 g	250 g 350 g 450 g	P80
A-4 Kött	250 g 350 g 450 g	250 g 350 g 450 g	P100
A-5 Pasta	50 g (med 450 ml kallt vatten) 100 g (med 800 ml kallt vatten)	50 g 100 g	P80
A-6 Potatis	200 g 400 g 600 g	200 g 400 g 600 g	P100
A-7 Fryst pizza	200 g 400 g	200 g 400 g	P100/Grill
A-8 Soppa	200 ml 400 ml	200 400	P80

11. BARNLÅS

Den här funktionen kan du använda för att förhindra att barn av misstag sätter på ugnen.

- a** För att aktivera låset:
I standbyläge håller du  intryckt i tre sekunder.
Ett pip hörs och låsikonen visas.



- b** För att inaktivera låset:
I låst läge håller du  intryckt i tre sekunder.
Ett pip hörs.



12. INFORMATIONSFUNKTION

- a** Vid tillagning i ugnen kan du trycka på  Timer/Clock, så visas den aktuella tiden på displayen i tre sekunder.



- b** I mikrovågsugnsens tillagningsläge kan du trycka på  Microwave för att få information om effektnivån. Informationen visas i tre sekunder.



- c** I läget för grillning och kombinerad tillagning kan du trycka på  Grill/Combi. för att få information om tillagningsläget. Informationen visas i tre sekunder.



RENGÖRING

Med god skötsel och rengöring kommer apparaten att behålla sitt utseende och förbli fullt fungerande under lång tid framöver. Vi kommer att förklara här hur du ska sköta och rengöra din apparat på rätt sätt.



VARNING

- Repat glas i luckan kan utvecklas till en spricka. Använd inte en glasskrapa, vassa eller slipande rengöringsmedel eller rengöringsmedel.
- Ytan på apparaten kan skadas om den inte rengörs ordentligt. Energi från mikrovågsugnen kan strömma ut. Rengör apparaten regelbundet och ta bort eventuella matrester genast.
- Sänk inte ner apparaten i vatten eller rengör den under en vattenstråle.

Rengöringsmedel

För att säkerställa att de olika ytorna inte skadas av att fel rengöringsmedel används, se informationen nedan. Tvätta nya svampdukar noggrant före användning.

Använd inte:



Starka eller slipande rengöringsmedel



Metall- eller glasskrapor för att rengöra luckans paneler



Metall- eller glasskrapor för att rengöra luckans tätning



Hårda skursvampar eller svampar



Rengöringsmedel med hög alkoholhalt

APPARATEN FRAMIFRÅN

Varmt tvålatten:

Rengör med en disktrasa och torka sedan med en mjuk trasa. Använd inte metall- eller glasskrapor för rengöring.

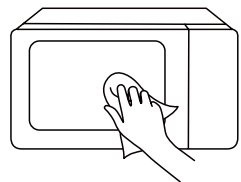

RENGÖRING

APPARATENS FRAMPLATTA

Varmt tvålvatten:

Rengör med en disktrasa och torka sedan med en mjuk trasa. Torka omedelbart av stänk och fläckar av kalk, fett, stärkelse och albumin. Korrosion kan bildas under dessa fläckar eller stänk. Använd inte glasrengöringsmedel eller metall- eller glasskrapor för rengöring.

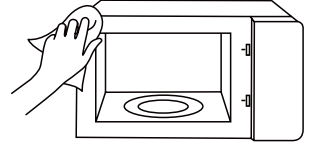

APPARATENS HÅLRUM

Varmt tvålvatten eller vinäger:

Rengör med en disktrasa och torka sedan med en mjuk trasa. Använd inte ugnsspray eller andra aggressiva ugnsgöringsmedel eller slipande material. Skursvampar, grova svampar och rengöringsmedel till stekpannor är också olämpliga. Dessa produkter repar ytan. Låt de inre ytorna torka helt.

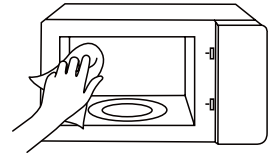

URTAGET I UGNSUTRYMMET

Fuktig trasa:

Vatten får inte rinna in i apparaten genom tallrikens drivenhet. Torka tallriken med en trasa.

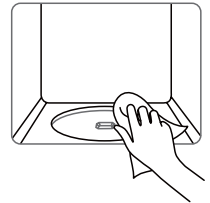

TALLRIK OCH ROTERANDE RING

Varmt tvålvatten:

När du sätter tillbaka tallriken i urtaget måste den haka i ordentligt.

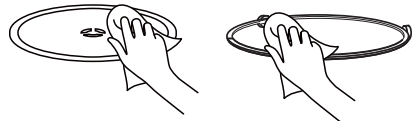

LUCKPANEL

Glasrengöringsmedel:

Rengör med en disktrasa. Använd inte glasskrapor.

FELSÖKNING

Kontrollera ditt problem genom att använda tabellen nedan och prova lösningarna för varje problem.

Om mikrovågsugnen fortfarande inte fungerar som den ska, kontakta närmaste auktoriserade servicecenter.

PROBLEM	MÖJLIG ORSAK	MÖJLIG LÖSNING
Ugnen startar inte	<ul style="list-style-type: none"> a. Elsladd för ugnen är inte ansluten. b. Luckan är öppen. c. Fel funktion är inställd. 	<ul style="list-style-type: none"> a. Sätt i eluttaget. b. Stäng luckan och försök igen. c. Kontrollera instruktionerna
Bågbildning eller gnistor	<ul style="list-style-type: none"> a. Material som skulle undvikas i mikrovågsugn användes. b. Ugnen körs när den är tom. c. Spilld mat finns kvar i hållrummet. 	<ul style="list-style-type: none"> a. Använd endast köksredskap som tål mikrovågsugn. b. Kör inte med tom ugn. c. Rengör hållrummet med en mjuk fuktig trasa.
Ojämnt tillagad mat	<ul style="list-style-type: none"> a. Material som skulle undvikas i mikrovågsugn användes. b. Maten är inte helt upptinad. c. Tillagningstid, effektnivån är inte lämplig. d. Maten vänds eller rörs inte om. 	<ul style="list-style-type: none"> a. Använd endast köksredskap som tål mikrovågsugn. b. Tina upp maten helt. c. Använd rätt tillagningstid, effektnivå. d. Vänd eller rör om maten.
Överkokt mat	Tillagningstid, effektnivå är inte lämplig.	Använd rätt tillagningstid, effektnivå.
Underkokt mat	<ul style="list-style-type: none"> a. Material som skulle undvikas i mikrovågsugn användes. b. Maten är inte helt upptinad. c. Ugnens ventilationsportar är begränsade. d. Tillagningstid, effektnivån är inte lämplig. 	<ul style="list-style-type: none"> a. Använd endast köksredskap som tål mikrovågsugn. b. Tina upp maten helt. c. Kontrollera att ugnsv ventilationsportarna inte är begränsade. d. Använd rätt tillagningstid, effektnivå
Felaktig upptining	<ul style="list-style-type: none"> a. Material som skulle undvikas i mikrovågsugn användes. b. Tillagningstid, effektnivån är inte lämplig. c. Maten vänds inte eller rörs om. 	<ul style="list-style-type: none"> a. Använd endast köksredskap som tål mikrovågsugn. b. Använd rätt tillagningstid, effektnivå. c. Vänd eller rör om maten.



Enligt WEEE-direktivet (Waste of Electrical and Electronic Equipment) ska WEEE samlas in och behandlas separat. Om du vid något tillfälle i framtiden behöver kassera denna produkt, släng INTE denna produkt med hushållsavfallet. Skicka den här produkten till WEEE-uppsamlingsställen där den är tillgänglig.

#DetailsMatter

BRUGERVEJLEDNING

MIKROBØLGEOVN

MW3-AG20PE(BK) / MW3-AG20PE(WH)

Læs denne brugervejledning, før du betjener apparatet.

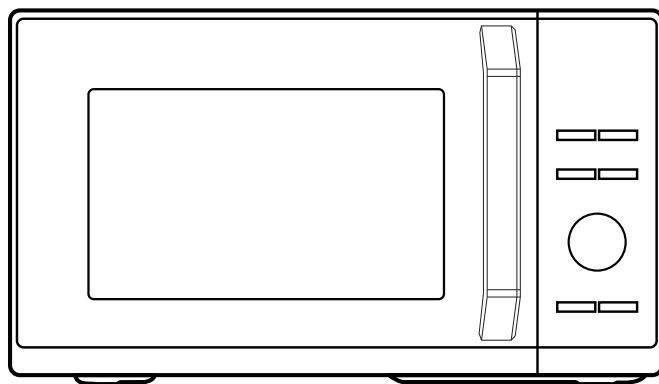

TOSHIBA

INDHOLD

PRODUKTSIKKERHED

Forholdsregler for at undgå mulig eksponering for kraftig mikrobølgeenergi	DA-01
Vigtige sikkerhedsanvisninger	DA-03
Installation af jordforbindelse fo at reducere risiko for personskade	DA-08
Rengøring	DA-10
Redskaber	DA-11
Materialer, du kan bruge i mikrobølgeovnen	DA-12
Materialer, du ikke kan bruge i mikrobølgeovnen	DA-14

INDSTILLING AF PRODUKTET

Sådan konfigurerer du din ovn	DA-15
-------------------------------------	-------

BRUGSANVISNING

Før du bruger apparatet første gang	DA-19
Betjening	DA-20
1.Indstilling af uret	DA-21
2.Indstilling af køkkentimeren	DA-22
3.Tilberedning med mikrobølger	DA-22
4. Tilberedning med grill	DA-23
5.Tilberedning med kombinationsprogram	DA-24
6. Optøning efter tid	DA-25
7. Optøning efter vægt	DA-25
8. Hurtig tilberedning	DA-26

9.Tilberedning I flere trin	DA-26
10.Automatisk menu	DA-27
11.Børnelås	DA-29
12.Oplysningsfunktion	DA-29
Rengøring	DA-30

VEDLIGEHOLDELSE

Fejlsøgning	DA-32
-------------------	-------



BEMÆRK

DISSE ANVISNINGER SKAL LÆSES, FORSTÅS OG FØLGES, FØR DU BETJENER PRODUKTET. SØRG FOR AT GEMME DENNE BETJENINGSVEJLEDNING TIL FREMTIDIG BRUG.

PRODUKTSIKKERHED

FORHOLDSREGLER FOR AT UNDGÅ MULIG EKSPONERING FOR KRAFTIG MIKROBØLGEENERGI

- (a). Forsøg ikke at betjene ovnen med døren åben, da det kan medføre farlig eksponering for mikrobølgeenergi. Det er vigtigt ikke at bryde eller manipulere sikkerhedslåsene.
- (b). Du må ikke anbringe genstande mellem ovnens forside og ovndøren eller lade skidt eller rengøringsrester ophobes på tætningsfladerne.
- (c). **ADVARSEL:** Hvis døren eller dørtætningerne beskadiges, må ovnen ikke betjenes, før en kvalificeret tekniker har repareret den.

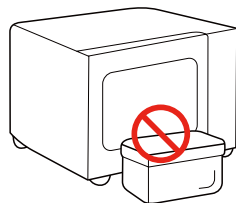

TILLÆG

Hvis apparatet ikke holdes rent, kan dets overflade forringes og påvirke apparatets levetid, og der kan opstå farlige situationer.

SPECIFIKATIONER

MODEL	MW3-AG20PE(BK) / MW3-AG20PE(WH)
NOMINEL SPÆNDING/FREKVENNS	230 V~ 50 Hz
NOMINEL INDGANGSEFFEKT (MIKROBØLGE)	1270 W
NOMINEL UDGANGSEFFEKT (MIKROBØLGE)	800 W
NOMINEL INDGANGSEFFEKT (GRILL)	1000 W

ENERGIFORBRUG

Produktinformation om strømforbrug og maksimal tid til at nå den relevante lavenergitilstand.

Standby-tilstand	0.8 W
Den maksimale tid, det tager for mikrobølgeovnen automatisk at nå den relevante tilstand med lavt strømforbrug.	20 minutter



BEMÆRK

Alle billeder i denne vejledning er kun vejledende. Disse kan afvige lidt fra dem på det købte udstyr. Se det faktiske produkt.

VIGTIGE SIKKERHEDSANVISNINGER



ADVARSEL

For at reducere risiko for brand, elektriske stød, personskade eller eksponering for kraftig mikrobølgeenergi fra ovnen, når du bruger apparatet, skal du følge grundlæggende forholdsregler, herunder følgende:



Læs og følg de bestemte: **"FORHOLDSREGLER FOR AT UNDGÅ MULIG EKSPONERING FOR KRAFTIG MIKROBØLGEENERGI"**.



Dette apparat kan benyttes af børn på 8 år og derover og personer med begrænsede fysiske, sensoriske eller mentale evner eller manglende erfaring og viden, såfremt de er blevet vejledt eller instrueret i brugen af apparatet på en sikker måde og forstår de involverede farer. Børn må ikke lege med apparatet. Børn uden opsyn må ikke rengøre eller vedligeholde apparatet.



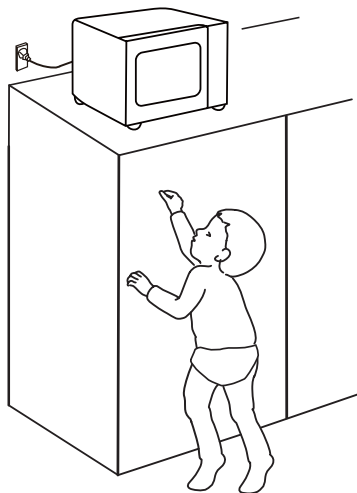

Hold apparatet og ledningen utilgængeligt for børn under 8 år.





VIGTIGE SIKKERHEDSANVISNINGER

 Hvis netledningen er beskadiget, skal den udskiftes af producenten, dennes autoriserede servicecenter eller tilsvarende kvalificerede teknikere for at undgå fare.

 **ADVARSEL:** Sørg for, at apparatet er slukket, inden du udskifter pæren, for at undgå elektrisk stød.

 **ADVARSEL:** Det er farligt for andre end en kvalificeret person at udføre evt. service- eller reparationsarbejde indebærende fjernelse af et dæksel, der giver beskyttelse mod eksponering for mikrobølgeenergi.

 **ADVARSEL:** Væsker og andre madvarer må ikke opvarmes i forseglede beholdere, da de er tilbøjelige til at eksplodere.

 Når du opvarmer madvarer i plastik- eller papirbeholdere, skal du holde øje med ovnen, da der er mulighed for antændelse.



 Brug kun redskaber, der er egnede til brug i mikrobølgeovne.

 Hvis apparatet udsender røg, skal du slukke det eller trække stikket ud af stikkontakten og holde døren lukket for at kvæle evt. flammer.

 Mikrobølgeopvarmning af drikkevarer kan medføre forsinket kraftig kogning. Der skal derfor udvises forsigtighed, når beholderen håndteres.

 Indholdet af sutteflasker og glas til babymad skal omrøres eller rystes, og

VIGTIGE SIKKERHEDSANVISNINGER

temperaturen skal kontrolleres før indtagelse for at undgå forbrændinger.

 **ADVARSEL:** Når apparatet betjenes i kombinationstilstand, må børn kun bruge ovnen under tilsyn af en voksen på grund af de opnåede temperaturer.

 Hvis ovnen ikke holdes i ren stand, kan det medføre forringelse af overfladen, hvilket kan påvirke apparatets levetid negativt og muligvis medføre en farlig situation.

 Brug kun stegetemperaturspyddet, der anbefales til ovnen (gælder for ovne med en funktion til brug af stegetemperaturspyd).

 Mikrobølgeovnen skal betjenes med den dekorative dør åben (for ovne med en dekorativ dør).

 Apparatet er beregnet til husholdningsbrug eller lignende anvendelse, som f.eks.:

1. i køkkenområder i butikker, på kontorer og i andre arbejdsmiljøer;
2. af kunder på hoteller, moteller og andre boligmiljøer;
3. gårde;
4. gæsteboliger og pensionater.

 Mikrobølgeovnen er beregnet til opvarmning af mad- og drikkevarer. Tørring af madvarer eller tøj og opvarmning af varmepuder, tøfler, svampe, fugtige klude og lignende kan føre til risiko for personskade, antændelse eller brand.

VIGTIGE SIKKERHEDSANVISNINGER

 Apparatet er kun beregnet til at blive brugt fritstående.

 Apparatets bagside skal anbringes mod en væg.

 Temperaturen på tilgængelige overfaldere kan være høj, når apparatet er i drift.

 Ovnen skal rengøres med jævne mellemrum, og evt. madaflejringer skal fjernes. Hold bølgelederområdet rent. Brug en blød, fugtig klud til at rengøre den, hvis der er madrester på bølgelederområdet eller hulrummet. Hvis madrester ikke rengøres, kan det forårsage uskadelige gnister eller røg i mikroovnens hulrum, og der kan også forekomme misfarvning af hulrummet.

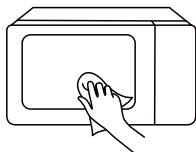

 Æg i deres skal og hele hårdkogte æg må ikke opvarmes i mikrobølgeovne, da de kan eksplodere, selv efter at mikrobølgeopvarmningen er afsluttet.

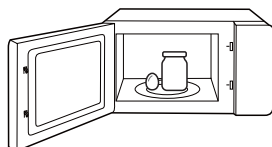



 Mikrobølgeovnen må ikke placeres i et skab, medmindre den er blevet afprøvet i et skab.

 Metalliske beholdere til mad- og drikkevarer er ikke tilladt under mikrobølgetilberedning.

 Apparatet må ikke rengøres med damprensere.

VIGTIGE SIKKERHEDSANVISNINGER

 Apparaterne er ikke beregnede til brug med en ekstern timer eller et separat fjernbetjeningsystem.

 Apparatet må ikke installeres bag en dekorativ dør for at undgå overophedning (dette gælder ikke apparater med en dekorativ dør).

LÆS OMHYGGELIGT, OG OPBEVAR TIL
FREMTIDIG BRUG

INSTALLATION AF JORDFORBINDELSE FOR AT REDUCERE RISIKOEN FOR PERSONSKADE

Apparatet skal jordforbindes. I tilfælde af en elektrisk kortslutning reducerer jordforbindelsen risikoen for elektrisk stød ved at give elektrisk strøm en flugtlejning.

Apparatet er udstyret med en ledning, der er udstyret med en jordledning og et jordforbundet stik. Stikket skal sættes i en stikkontakt, der er installeret og jordforbundet korrekt.

ADVARSEL – forkert anvendelse af jordforbindelsen kan medføre risiko for elektrisk stød. Kontakt en kvalificeret elektriker eller tekniker, hvis du ikke forstår vejledningen til jordforbindelse helt, eller hvis du er i tvivl, om apparatet er jordforbundet korrekt. Hvis det er nødvendigt at bruge en forlængerledning, skal der bruges en med et 3-polet jordforbundet stik.



FARE

Risiko for elektrisk stød:

Hvis der røres ved nogle af de interne komponenter, kan det medføre alvorlig personskade eller død.

Apparatet må ikke adskilles.

INSTALLATION AF JORDFORBINDELSE FOR AT REDUCERE RISIKOEN FOR PERSONSKADE



ADVARSEL

Risiko for elektrisk stød:

Forkert anvendelse uden jordforbindelse kan føre til elektrisk stød. Sæt ikke stikket i stikkontakten, før apparatet er installeret og jordforbundet korrekt.

1. Der leveres en kort netledning for at reducere risiciene som følge af, at den vikler sig ind, eller at man snubler over en længere ledning.
2. Hvis der bruges en lang ledning eller forlængerledning:
 - (1). De markerede elektriske mærkedata på ledningen eller forlængerledningen skal mindst matche apparatets elektriske mærkedata.
 - (2). Forlængerledningen skal være en med et 3-polet jordforbundet stik.
 - (3). Den længere ledning skal ordnes således, at den ikke hænger over bordpladen, hvor børn kan trække i den eller snuble over den utilsigtet.

RENGØRING

Sørg for at trække stikket på apparatet ud af strømforsyningen.

1. Rengør ovnrummet efter brug med en let fugtig klud.
2. Rengør tilbehøret på normal vis i sæbevand.
3. Dørkarmen, tætningen og de tilstødende dele skal rengøres omhyggeligt med en fugtig klud, når de er snavsede.
4. Brug ikke hårde slibemidler eller skarpe metalskrabere til at rengøre ovndørens glas, da de kan ridse overfladen, hvilket kan resultere i, at glasset går i stykker.
5. Råd til rengøring – til rengøring af de rumvægge, som maden under tilberedning kan røre: Anbring en halv citron i en skål, tilføj 300 ml vand, og varm op på 100 % mikrobølgeeffekt i 10 minutter. Aftør ovnen med en blød, tør klud.

REDSKABER



FORSIGTIG

Fare for personskade:

Det er farligt for andre end en kvalificeret person at udføre evt. service- eller reparationsarbejde indebærende fjernelse af et dæksel, der giver beskyttelse mod eksponering for mikrobølgeenergi. Se vejledningen til "**Materialer, du kan bruge i mikrobølgeovnen**" eller "**Materialer, du ikke må bruge i mikrobølgeovnen**".

Der kan være visse ikke-metalliske redskaber, der ikke er sikre at bruge til mikrobølgetilberedning. Hvis du er i tvivl, kan du afprøve det pågældende redskab ved at følge proceduren herunder.

Redskabstest:

1. Fyld en mikrobølgesikker beholder med 1 kop koldt vand (250 ml) sammen med det pågældende redskab.
2. Kog på maks. effekt i 1 min.
3. Mærk forsigtigt på redskabet. Hvis det tomme redskab er varmt, må det ikke bruges til mikrobølgetilberedning.
4. Tilberedningstiden må højst være 1 min.

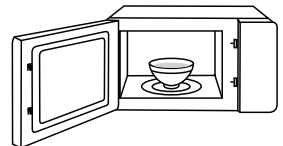

BEMÆRK

HOLD RUMMET OG OMRÅDET
TIL BØLGELEDER RENE

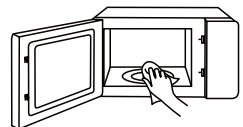

MATERIALER, DU KAN BRUGE I MIKROBØLGEOVNEN

REDSKABER

BEMÆRKNINGER



Stegefad

Følg producentens anvisninger.
En bageplades bund skal være mindst 5 mm over
drejetallerkenen. Forkert brug kan få drejetallerkenen
til at gå i stykker.



Bordservice

Kun mikrobølgesikker. Følg producentens anvisninger.
Brug ikke revnede eller brækkede tallerkender.



Glasbeholdere

Fjern altid låget. Bruges kun til at varme mad op,
indtil den lige er varm. De fleste glasbeholdere er
ikke varmebestandige og kan gå i stykker.



Glasvarer

Kun varmebestandige glasvarer til ovn. Sørg for, at
der ikke er nogen metalkanter. Brug ikke revnede
eller brækkede tallerkender.



Stegeposer til ovn

Følg producentens anvisninger. Luk ikke med en
metalklemme.
Skær revner, så dampen kan slippe ud.



Paptallerkener og
-kopper

Bruges kun til kortvarig tilberedning/opvarmning.
Efterlad ikke ovnen uden opsyn, mens den kører.



Papirservietter

Bruges til at dække mad til genopvarmning og til at
opsuge fedt. Bruges kun under opsyn til kortvarig
tilberedning.

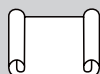

Bagepapir

Bruges som et låg til at forhindre sprøjt eller som
indpakning til dampkogning.



MATERIALER, DU KAN BRUGE I MIKROBØLGEOVNEN

REDSKABER

BEMÆRKNINGER



Plastik

Kun mikrobølgesikker. Følg producentens anvisninger. Skal være mærket "Mikrobølgesikker". Nogle plastbeholdere blødgøres, når maden inde i bliver varm. "Kogeposer" og tættillukkede plastikposer skal revnes, punkteres eller ventileres som angivet på pakken.



Plastfolie

Kun mikrobølgesikker. Bruges til at dække maden under tilberedning for at bevare fugtindholdet. Der må ikke tillades, at plastfolie rører maden.



Termometre

Kun mikrobølgesikker (kød- og sliktermometre).



Vokspapir

Brug som et låg for at forhindre sprøjt og bevare fugtindholdet.



MATERIALER, DU IKKE KAN BRUGE I MIKROBØLGEOVNEN

REDSKABER

BEMÆRKNINGER



Aluminiumstallerken

Kan medføre gnistdannelse. Overfør mad til en mikrobølgesikker tallerken.



Mademballage med metalgreb

Kan medføre gnistdannelse. Overfør mad til en mikrobølgesikker tallerken.



Metalredskaber eller redskaber med metalkanter

Metal beskytter maden mod mikrobølgeenergi. Metalkanter kan forårsage gnistdannelse.



Metalposelukkere

Kan forårsage gnistdannelse og dermed brand i ovnen.



Papirposer

Kan forårsage brand i ovnen.



Skumplast

Skumplast kan smelte eller forurene væske indeni, når den anvendes.



Træ

Træ tørrer ud, når det bruges i mikrobølgeovnen og kan opdeles eller revne.



INDSTILLING AF PRODUKTET

SÅDAN KONFIGURERER DU DIN OVN

NAVNE PÅ MIKROBØLGEOVNENS DELE OG TILBEHØR

Tag ovnen ud samt alt materiale fra kassen og ovnrummet.



Glastallerken

(kan bruges med alle funktioner)

Grillrist (kan ikke bruges sammen med mikrobølgefunktionen og skal anbringes på glass tallerkenen)

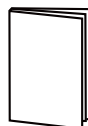

Brugervejledning

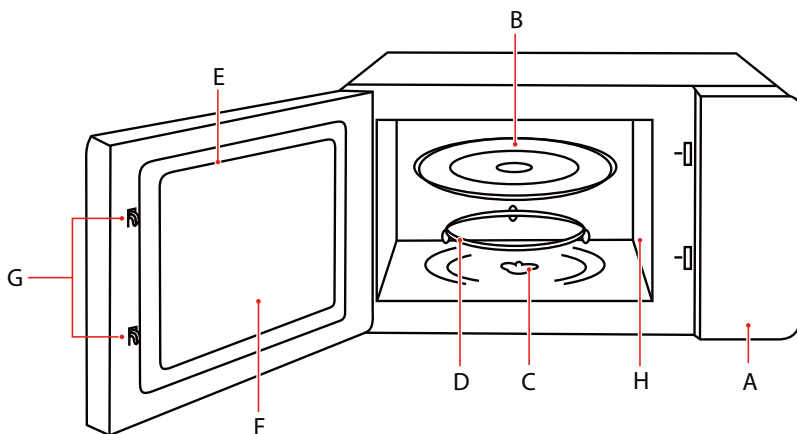

A. Kontrolpanel

B. Glastallerken

C. Drejetallerkenens aksel

D. Rullestøtte til drejetallerken

E. Dørenhed

F. Observationsvindue

G. Sikkerhedslåsesystem

H. Dæksel til bølgeleder



BEMÆRK

I tilfælde af forskelle mellem apparatet og billederne i vejledningen gælder produktet.

SÅDAN KONFIGURERER DU DIN OVN

INSTALLATION AF DREJETALLERKENEN

Sådan rengøres tilberedningsrummet og anbringes drejetallerkenen på plads.

For nye installationer skal du sikre, at al emballage og forsendelsestape er fjernet fra drejetallerkenens aksel.

Før du bruger apparatet til at tilberede mad første gang, skal du sætte drejetallerkenen korrekt på plads. Du skal rengøre tilberedningsrummet og tilbehøret.

Sådan sætter du drejetallerkenen på plads:

1. Anbring rullestøtten til drejetallerkenen ③ ind i forsænkningen i tilberedningsrummet.
2. Anbring glastallerkenen ① på rullestøtten til drejetallerkenen ③.

Pas de løftede, krummede linjer i midten af glastallerkenens bund ind i de tre raterger på akslen. Kontrollér, at glastallerkenen ① griber ind i drejetallerkenens aksel ② i midten af tilberedningsrummets gulv. Valserne på akslen skal passe ind i tallerkenens bundkant.

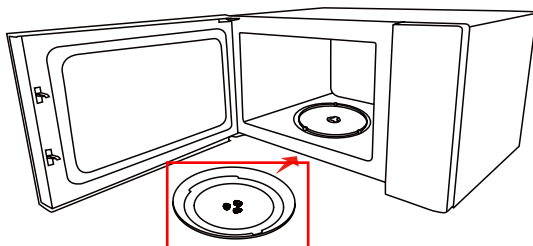
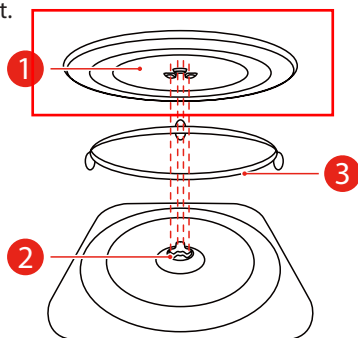

- Brug aldrig apparatet uden drejetallerkenen. Kontrollér, at den er i indgreb korrekt. Drejetallerkenen kan dreje med eller mod uret.
- Vend aldrig glastallerkenen på hovedet. Glastallerkenen må aldrig begrænses.
- Glastallerkenen og rullestøtten til drejetallerkenen skal altid bruges under tilberedning.
- Al mad og alle madbeholdere skal altid placeres på glastallerkenen til tilberedning.
- Drejetallerkenens bevægelse må aldrig begrænses.
- Hvis glastallerkenen eller rullestøtten til drejetallerkenen revner eller går i stykker, skal du kontakte det nærmeste autoriserede servicecenter.

SÅDAN KONFIGURERER DU DIN OVN

INSTALLATION PÅ BORDPLADE

Fjern alt emballeringsmateriale og tilbehør. Ovnens skal undersøges for eventuelle skader, som f.eks. buler eller ødelagt dør. Installer ikke, hvis ovnen er beskadiget.

Skab: Fjern evt. beskyttelsesfilm, der findes på overfladen af skabet til mikrobølgeovnen. Fjern ikke det lysebrune dæksel til bølgeleder, der er fastgjort til ovnrummet, for at beskytte magneten.

INSTALLATION

1. Vælg en plan overflade, der giver tilstrækkelig åben plads til indsugnings- og/eller udluftningsåbningerne.
 - a. Den minimale installationshøjde er 85 cm.
 - b. Apparatets bagside skal anbringes op mod en væg. Efterlad en minimal fri afstand på 30 cm over ovnen. Der kræves en minimal fri afstand på 20 cm mellem ovnen og evt. tilstødende vægge.
 - c. Fødderne må ikke fjernes fra bunden af ovnen.
 - d. Hvis indsugnings- og/eller udluftningsåbningerne blokeres, kan det beskadige ovnen.
 - e. Anbring ovnen så langt væk fra radioer og tv'er som muligt.
Betjening af mikrobølgeovnen kan forårsage interferens med din radio- eller tv-modtagelse.

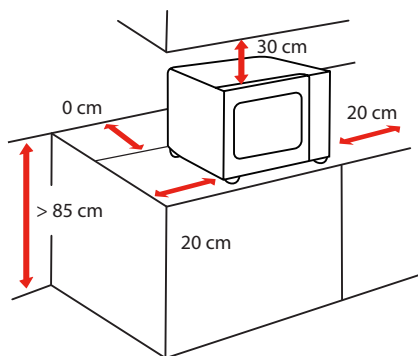

SIDE	AFSTAND CM
Top	30 cm
Venstre	20 cm
Højre	20 cm
Bagside	0 cm
Forside	Åbn

SÅDAN KONFIGURERER DU DIN OVN

2. Sæt din ovn i en almindelig husholdningsstikkontakt. Sørg for, at spændingen og frekvensen svarer til spændingen og frekvensen på mærkaten med arbejdsværdier.



ADVARSEL

- Installér ikke ovnen over et komfur eller andet varmeproducerende apparat. Hvis den installeres i nærheden eller over en varmekilde, kan ovnen beskadiges, og garantien kan ugyldiggøres.

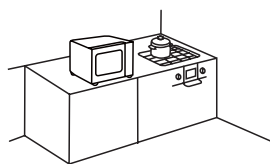

Den tilgængelige overflade kan være varm under drift.

BRUGSANVISNING

FØR DU BRUGER APPARATET FØRSTE GANG

Apparatet kan producere ubehagelige lugte, når det bruges første gang.

Dette afsnit fortæller dig, hvad du skal gøre, før du bruger din mikrobølgeovn til at tilberede mad første gang. Læs på forhånd afsnittet "**VIGTIGE SIKKERHEDSANVISNINGER**" på side 3.

Før du kan bruge dit nye apparat, skal du sætte drejetallerkenen korrekt på plads. Du skal også rengøre tilberedningsrummet og tilbehøret.



BEMÆRK

- Brug aldrig apparatet uden drejetallerkenen.
- Kontrollér, at den er i indgreb korrekt. Drejetallerkenen kan dreje med eller mod uret.

BETJENING

KONTROLPANEL OG FUNKTIONER

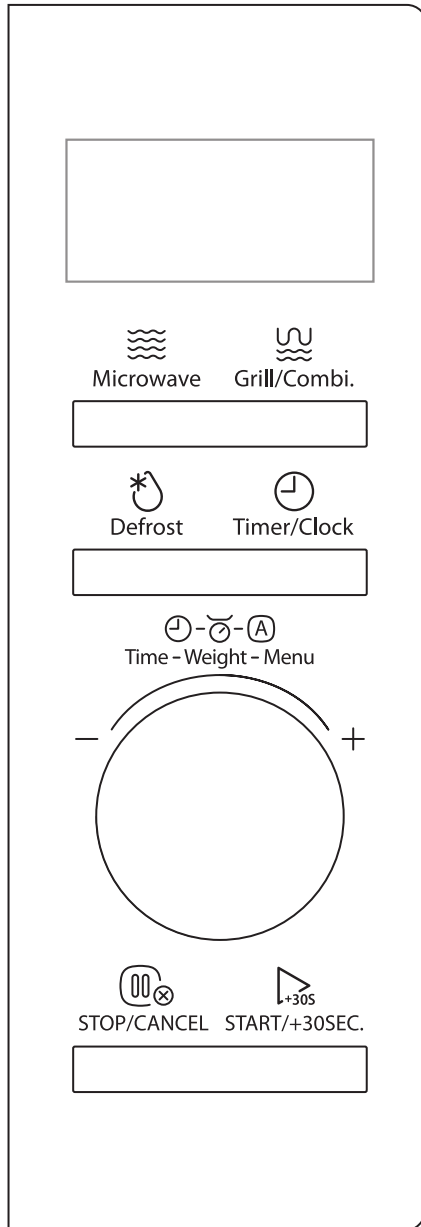

1. INDSTILLING AF URET

- a Tryk to gange på  Timer/Clock. "00:00" vises.



- b Drej knappen for at indstille timetallet.

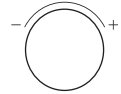

- c Tryk på  Timer/Clock eller  START/+30SEC. for at bekræfte timetallet.



eller



- d Drej knappen for at indstille minuttallet.

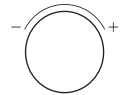

- e Tryk på  Timer/Clock eller  START/+30SEC. for at bekræfte. Uret er indstillet.

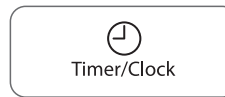

eller



BEMÆRK

- Uret viser tiden i 24 timers format. Uret virker ikke, når apparatet tændes, hvis klokkeslættet ikke er indstillet.
- Gentag trin a-e for at nulstille uret.

2. INDSTILLING AF KØKKENTIMEREN

a Tryk på  Timer/Clock. "00:00" vises.



b Drej knappen for at indstille den ønskede tid. Den maksimale tid er "95:00".

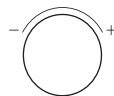

c Tryk på  START/+30SEC. for at bekræfte. Timeren begynder at tælle ned.



- Køkkentimeren er en timer.
- Ingen andre programmer kan indstilles under køkkentimeren.

3. TILBEREDNING MED MIKROBØLGER

Der findes 5 effektniveauer.

NIVEAU	EFFEKT	DISPLAY
1	100 %	P100
2	80 %	P80
3	50 %	P50
4	30 %	P30
5	10 %	P10

Tryk gentagne gange på  Microwave for at vælge effektniveau.

a eller

Tryk på , og drej derefter knappen for at indstille effektniveauet.

De 5 effekt niveauer er tilgængelige.



b Tryk på  START/+30SEC. for at bekræfte effekt-niveauet.



c Drej knappen for at indstille tilberedningstiden. Den maksimale tid er "95:00".

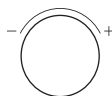

d Tryk på  START/+30SEC. for at starte tilberedningen.



4. TILBEREDNING MED GRILL

a Tryk på  Grill/Combi. "G-1" vises.



b Tryk på  START/+30SEC. for at bekræfte programmet.



c Drej knappen for at indstille tilberedningstiden. Den maksimale tid er "95:00".

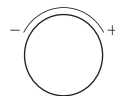

d Tryk på  START/+30SEC. for at starte tilberedningen.



• Brummen lyder for at minde dig om at vende maden under tilberedningen. Hvis du ikke foretager dig noget, fortsætter ovnen.

5. TILBEREDNING MED KOMBINATIONSPROGRAM

a Tryk gentagne gange på  Grill/Combi. for at vælge det ønskede tilberedningsprogram. "C-1" og "C-2" er tilgængelige.



eller

b Tryk på  Grill/Combi. , og drej derefter knappen for at vælge tilberedningsprogram.



c Tryk på  START/+30SEC. for at bekræfte programmet.



d Drej knappen for at indstille tilberedningstiden. Den maksimale tid er "95:00".

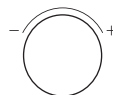



e Tryk på  START/+30SEC. for at starte tilberedningen.



DIAGRAM OVER KOMBINATIONSTILBEREDNING

PROGRAM	DISPLAY	MIKROBØLGEEFFEKT	GRILLEFFEKT
Kombination 1	C-1	55 %	45 %
Kombination 2	C-2	36 %	64 %

6. OPTØNING EFTER TID

- a Tryk to gange på  Defrost . "dEF2" vises.



- b Drej knappen for at indstille optøningstiden. Den maksimale tid er "95:00".

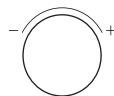

- c Tryk på  START/+30SEC. for at starte optøningen.



BEMÆRK

- Brummeren lyder for at minde dig om at vende maden under optøningen. Hvis du ikke foretager dig noget, fortsætter ovnen.
- Optøningseffekten er P30 og kan ikke ændres.

7. OPTØNING EFTER VÆGT

- a Tryk på  Defrost . "dEF1" vises.

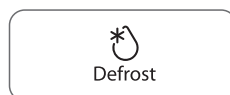

- b Drej knappen for at indstille vægten af maden. Vægten skal være inden for intervallet 100-2.000 g.

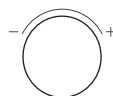

- c Tryk på  START/+30SEC. for at starte optøningen.



8. HURTIG TILBEREDNING

- a** Drej knappen til venstre for at indstille en tilberedningstid med en effekt på 100 %.

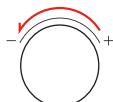

- b** Fortsæt med at dreje knappen for at indstille tilberedningstiden. Den maksimale tid er "95:00".



- c** Tryk på  START/+30SEC. for at starte tilberedningen.



- a** Tryk på  START/+30SEC. for at tilberede mad med 100 % effektniveau i 30 sekunder. Hvert tryk på den samme tast øger tiden med 30 sekunder, og den maksimale tid er "95:00".



9. TILBEREDNING I FLERE TRIN

Eksempel: Optø maden i fem minutter, og tilbered den derefter med 80 % mikrobølgeeffekt i syv minutter.

- a** Tryk to gange på  Defrost . "dEF2" vises.



- b** Drej knappen for at indstille den ønskede optøningstid til fem minutter.



- c** Tryk gentagne gange på  Microwave , indtil "P80" vises.



- d** Tryk på  START/+30SEC. for at bekræfte effektniveauet.



- e** Drej knappen for at indstille tilberedningstiden til syv minutter.

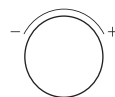

- f** Tryk på  START/+30SEC. for at starte tilberedningen.



BEMÆRK

- Der kan indstilles to tilberedningstrin i tilberedelse i flere trin.
- Hvis du indstiller optøningsfunktionen, fungerer den automatisk i første trin.
- Køkkentimeren og den automatiske menu kan ikke indstilles som et trin i tilberedelse i flere trin.

10. AUTOMATISK MENU

- a** Drej knappen én gang til højre i standbytilstand, hvorefter "A-1" vises.

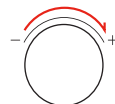

- b** Fortsæt med at dreje knappen for at vælge den menu, som du har brug for.
De 8 automatiske menuer er tilgængelige.



- c** Tryk på  START/+30SEC. for at bekræfte.



- d** Drej knappen for at indstille vægten af maden.



- e** Tryk på  START/+30SEC. for at starte tilberedningen.



DIAGRAM OVER AUTOMATISK MENU

MENU	VÆGT/ MÆNGDE	DISPLAY	EFFEKTNIVEAU
A-1 Automatisk genopvarmning	200 g 400 g 600 g	200 g 400 g 600 g	P100
A-2 Grøntsager	200 g 300 g 400 g	200 g 300 g 400 g	P100
A-3 Fisk	250 g 350 g 450 g	250 g 350 g 450 g	P80
A-4 Kød	250 g 350 g 450 g	250 g 350 g 450 g	P100
A-5 Pasta	50 g (med 450 g koldt vand) 100 g (med 800 g koldt vand)	50 g 100 g	P80
A-6 Kartofler	200 g 400 g 600 g	200 g 400 g 600 g	P100
A-7 Frossen pizza	200 g 400 g	200 g 400 g	P100/grill
A-8 Suppe	200 ml 400 ml	200 400	P80

11. BØRNELÅS

Du kan bruge funktionen til at forhindre børn i ved et uheld at tænde ovnen.

a Sådan aktiveres låsen:

Tryk på  i tre sekunder i standbytilstand.
Der lyder et bip, og låseikonet vises.



b Sådan deaktiveres låsen:

Tryk på  i tre sekunder i låst tilstand.
Der lyder et bip.



12. OPLYSNINGSFUNKTION

a Tryk på  Timer/Clock, når ovnen er i brug. Den aktuelle tid vises i displayet i tre sekunder.



b I tilberedningsprogrammet med mikrobølger skal du trykke på  for at få vist effektiveauet. Oplysningen vises i tre sekunder.



c I grill- og kombinationstilberedningsprogrammet skal du trykke på  Grill/Combi. for at få oplyst tilberedningsprogrammet. Oplysningen vises i tre sekunder.



RENGØRING

Ovnen beholder sit udseende med god pleje og rengøring og kan bruges i mange år fremover. Her forklarer vi, hvordan du skal pleje og rengøre apparatet korrekt.



ADVARSEL

- Ridset glas i apparatets dør kan udvikles til en revne. Brug ikke en glasskraber eller skarpe eller slibende rengøringshjælpemidler eller rengøringsmidler.
- Apparatus overflade kan blive beskadiget, hvis den ikke rengøres korrekt. Mikrobølgeenergi kan udslippe. Rengør apparatet med jævne mellemrum, og fjern evt. madrester med det samme.
- Apparatet må ikke nedsænkes i vand eller rengøres med vandstråle.

Rengøringsmiddel

Overhold oplysningerne herunder for at sikre, at de forskellige overflader ikke beskadiges ved at bruge det forkerte rengøringsmiddel. Vask grundigt nye svampeklude før brug.

Der må ikke bruges:



Hårde eller slibende rengøringsmidler



Metal- eller glasskrabere til at rengøre dørpanelerne



Metal- eller glasskrabere til at rengøre dørtætningen



Hårde skuresvampe eller svampe



Rengøringsmidler med højt alkoholindhold

APPARATETS FORSIDE

Varmt sæbevand:

Rengør med et viskestykke, og aftør så med en blød klud. Brug ikke metal- eller glasskrabere til rengøring.

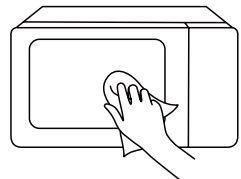

RENGØRING

APPARATETS FORFLADE

Varmt sæbevand:

Rengør med et viskestykke, og aftør så med en blød klud. Fjern sprøjt og kalk-, fedt-, stivelses- og albuminpletter med det samme. Der kan dannes korrosion under disse pletter eller sprøjt. Brug ikke præparater til rengøring af glas eller metal- eller glasskrabere til rengøring.

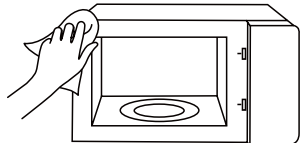

APPARATETS HULRUM

Varmt sæbevand eller eddikeopløsning:

Rengør med et viskestykke, og aftør så med en blød klud. Brug ikke ovnspray eller andre aggressive rengøringsmidler til ovn eller slibende materialer. Der må heller ikke bruges skuresvampe, ru svampe og rengøringsmidler til stegepander. Disse elementer ridser overfladen. Lad de indvendige overflader tørre helt.

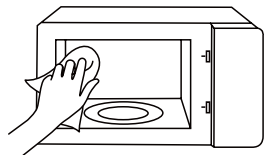

FORSÆNKNING I TILBEREDNINGSRUMMET

Fugtig klud:

Det må ikke tillades, at vand trænger ind i apparatet gennem drejetallerkenens drev. Aftør drejetallerkenens drev med en klud.

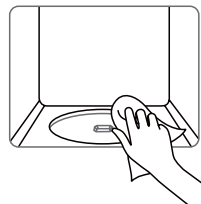

DREJETALLERKEN OG VALSERING

Varmt sæbevand:

Når du sætter drejetallerkenen tilbage i dens forsænkning, skal den gribe ind korrekt.

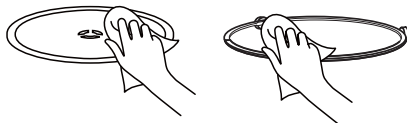

DØRPANEL

Præparat til rengøring af glas:

Rengør med et viskestykke. Brug ikke glasskrabere.

FEJLSØGNING

Tjek dit problem ved at bruge nedenstående skema, og prøv løsningerne for hvert problem. Hvis mikrobølgeovnen stadig ikke fungerer korrekt, skal du kontakte det nærmeste autoriserede servicecenter.

PROBLEM	MULIG ÅRSAG	MULIG LØSNING
Ovnen starter ikke	<ul style="list-style-type: none"> a. El-ledningen til ovnen er ikke sat i stikket. b. Døren er åben. c. Forkert funktion er indstillet. 	<ul style="list-style-type: none"> a. Sæt stikket i stikkontakten. b. Luk døren og prøv igen. c. Tjek instruktionerne
Bue- eller gnistdannelse	<ul style="list-style-type: none"> a. Materialer, du ikke må bruge i mikrobølgeovnen. b. Ovnen er i drift, når den er tom. c. Spildt mad forbliver i hulrummet. 	<ul style="list-style-type: none"> a. Brug kun køkkengrej, der kan tåle mikrobølger. b. Brug ikke ovnen, når den er tom. c. Rengør hulrummet med en blød fugtig klud.
Ujævnt tilberedt mad	<ul style="list-style-type: none"> a. Materialer, du ikke må bruge i mikrobølgeovnen. b. Maden er ikke helt optøet. c. Tilberedningstid, og effektniveau er ikke passende. d. Maden bliver ikke vendt eller rørt. 	<ul style="list-style-type: none"> a. Brug kun køkkengrej, der kan tåle mikrobølger. b. Tø maden helt op. c. Brug korrekt tilberedningstid, og effektniveau. d. Vend eller rør i maden.
Overtilberedt mad	Tilberedningstid, og effektniveau er ikke passende.	Brug korrekt tilberedningstid, og effektniveau.
Mad, der ikke er tilberedt nok	<ul style="list-style-type: none"> a. Materialer, du ikke må bruge i mikrobølgeovnen. b. Maden er ikke helt optøet. c. Ovnens ventilationsporte er tilstoppede. d. Tilberedningstid, og effektniveau er ikke passende. 	<ul style="list-style-type: none"> a. Brug kun køkkengrej, der kan tåle mikrobølger. b. Tø maden helt op. c. Kontroller, at ovnens ventilationsporte ikke er tilstoppede. d. Brug korrekt tilberedningstid, og effektniveau
Forkert optøning	<ul style="list-style-type: none"> a. Materialer, du ikke må bruge i mikrobølgeovnen. b. Tilberedningstid, og effektniveau er ikke passende. c. Maden bliver ikke vendt eller rørt. 	<ul style="list-style-type: none"> a. Brug kun køkkengrej, der kan tåle mikrobølger. b. Brug korrekt tilberedningstid, og effektniveau. c. Vend eller rør i maden.



I henhold til WEEE-direktivet, skal affald af elektrisk og elektronisk udstyr indsamles og behandles særskilt. Hvis du på et tidspunkt i fremtiden skal du bortskaffe produktet, bedes du IKKE bortskaffe det sammen med husholdningsaffald. Send produktet til steder til indsamling af affald af elektrisk og elektronisk udstyr, hvor det er tilgængeligt.

#DetailsMatter