

TOSHIBA



DISHWASHER INSTRUCTION MANUAL

Model:

DW-15F6(G)-MY



English

Read these instructions carefully before using your DISHWASHER, and keep it carefully.

SAFETY INSTRUCCIONES

All instructions described should be carefully read and followed.







- These instructions are precautions to prevent the risks of serious injury or death of the user, and any damages to property.

MARKINGS	
 WARNING	WARNING indicates high possibility of serious injury (*1) or death of the user.
 CAUTION	CAUTION indicates high possibility of serious injury (*2) or property loss (*3).



(*1) Serious injury - injury which requires hospitalization, lengthy treatment, or blindness, hot and cold skin burn, electric shock, broken bones or poisoning.











(*2) Injury - injury, skin burn or electric shock which does not require hospitalization or lengthy treatment.









(*3) Property loss - extended loss of houses, furniture, domestic animals or pets.

SYMBOLS	
 PROHIBITED!	 PROHIBITED! Indicates prohibited actions. Detailed instructions would be indicated on the inside of the circle or around the symbol in figures or in writing.
 IMPORTANT	 IMPORTANT! Indicates mandatory actions. Detailed instructions would be indicated on the inside of the circle or around the symbol in figures or in writing.
 CAUTION	 CAUTION! Recommends to take precautions. Detailed instructions would be indicated on the inside of the triangle or around the symbol in figures or in writing.











Warning











 Away from children	<ul style="list-style-type: none"> ● Do not allow below people to operate the dishwasher The dishwasher cannot be used by persons (including children) with reduced physical, sensory or mental capabilities, or lack of experience and knowledge, unless they have been given supervision or instruction concerning use of the appliance by a person responsible for their safety. ● Take care of children and ensure they will not play with the dishwasher. ● The packing material may be dangerous to children.
 No modification	<ul style="list-style-type: none"> ● Do not dismantle or modify the dishwasher. This may cause fire, electric shock or fault, and cause injuries. If repair is required, please contact with the vendor of the dishwasher.
 Electric shock	<ul style="list-style-type: none"> ● Use suitable power source according to the power indicated on the dishwasher nameplate. It will cause fire or electric shock. The use of improper power source may cause the socket overheated and cause fire.

 Disconnect power plug	<ul style="list-style-type: none"> ● Before cleaning or maintaining the dishwasher, disconnect the power plug first.
 No touch by wet hand	<ul style="list-style-type: none"> ● Do not connect or disconnect the power plug by wet hand. This may cause electric shock or fault and cause injuries.
 Electric shock	<ul style="list-style-type: none"> ● Do not use damaged power lines, power plug or loose power socket. This may cause electric shock or fault, and cause injuries or fires.
 No dis-assembly and repair without permission	<ul style="list-style-type: none"> ● Do not damage power line. Do not damage, cut, process power line or bend, pull, twist or bind power line. Besides, do not yank the metal part of the power line, or put weights on the line or clamp the power line. The power line may be damaged and cause fire or electric shock. If the power line is damaged, the damaged line must be replaced by the manufacturer or its service agent or personnel having similar qualification, so as to prevent dangers.
 No water spraying	<ul style="list-style-type: none"> ● Do not spray water directly onto the parts of the main body of the dishwasher. This may cause accidents of electric shock or short circuit.
 Away from flammable materials	<ul style="list-style-type: none"> ● Do not put flammable materials into the dishwasher. Do not put flammable materials of kerosene, gasoline, volatile oil, diluent, ethyl alcohol etc. as well as dishes having such matters into the dishwasher. It will may cause explosion or fire.
 Wipe off dust	<ul style="list-style-type: none"> ● Wipe off dust or dirt accumulated on the plug of power line. The accumulated dust or dirt may cause fire.
 Prohibit	<ul style="list-style-type: none"> ● Do not touch the inside of the cabinet, steam jets for during operation or 30 minutes after operation. There is a fear of burning.
 Instruction	<ul style="list-style-type: none"> ● Take out the dishes, clean filters, handle it more than 30 minutes after operation. There is a fear of burning.
 Prohibit	<ul style="list-style-type: none"> ● Do not use extension cord. It may cause fire due to heat.
 Instruction	<ul style="list-style-type: none"> ● If there is abnormality such as the spray arm is not moving, smoke or strange smell, immediately unplug the power plug and stop using the dishwasher. Please ask the agent you purchased for inspection/repair. There is a danger of electric shock, fire by electric leakage or short-circuiting.

 Insert plug	<ul style="list-style-type: none"> ● Insert the power plug securely to the base and let the cord go downward. <p>If the cord goes upward or if the plug is incompletely inserted, it may cause fire due to electric leakage or heat generation.</p>
 Prohibit	<ul style="list-style-type: none"> ● Do not operate by putting easily combustible items such as towels and cloth inside the cabinet of the dishwasher. <p>There is a fear of fire.</p>
 Instruction	<ul style="list-style-type: none"> ● Separate from the heat source such as gas stove 15 cm or more. <p>There are fears of fires and deformations.</p>
 Prohibit	<ul style="list-style-type: none"> ● Do not place anything on the main unit. <p>Do not place heavy objects or hot objects on top of the main unit, such as containers of water or hot water, heat appliances, glasses, electric products, cutlery etc.</p> <p>Falling by opening and closing the door may cause injury. Also, spilled water may deteriorate insulation and cause electric leakage and fire.</p>
 Away from flammable materials	<ul style="list-style-type: none"> ● Do not place the dishwasher near fire. ● Do not put the burning candle or cigarette on the dishwasher. It may cause fire.
 Careful installation	<ul style="list-style-type: none"> ● Make sure the dishwasher can be set at a smooth drainage location. <p>The use of dishwasher having poor drainage may cause water to flow back to the dishwasher and cause electric shock or fire.</p>
 Correct grounding	<ul style="list-style-type: none"> ● The dishwasher must be grounded. <p>The current resistance are minimum after grounding, and this can reduce the danger of electric shock when the dishwasher become fault state. The electric wires of this dishwasher have grounding wire and grounding plug.</p> <p>Fault connection of the grounding wire will cause electric shock. If E3 failure occurs, please unplugging the power plug from the outlet, and needs to be repaired by professional electricians or service men.</p>
 No dis-assembly and repair without permission	<ul style="list-style-type: none"> ● Do not change the plug without permission. <p>When the plug does not match the socket, proper power socket shall be installed by professional electricians.</p>

⚠ Caution

 No pulling by force	<ul style="list-style-type: none"> When disconnecting the plug from the socket, do not pull the power line by force. Pull out by grasping the power plug. It may cause electric shock or fault and cause injuries.
 No use	<ul style="list-style-type: none"> Do not use soap, washing powder or other hand sanitizer. Only dishwashing powder suitable for automatic dishwasher. It may cause machine fault.
 No washing	<ul style="list-style-type: none"> Do not wash plastic utensils. For plastic utensils, only those marked with safety for the dishwasher or other similar situations, can be washed by the dishwasher. For the plastic utensils without marks, check details with the utensil manufacturer.
 Application environ- ment	<ul style="list-style-type: none"> Only for indoor use. Such home appliance is for household use, e.g.: <ul style="list-style-type: none"> - Applications in staff kitchen of shop, office and other working environments; - Farmhouse; - Use for customers in hotel, car hotel and other residence environments; - Environments of inns
 No climbing	<ul style="list-style-type: none"> Do not sit or stand on the dish rack or door of the dishwasher. It may cause dangers of injuries due to deformation or damage.
 Pull off power plug	<ul style="list-style-type: none"> When the dishwasher is not used for long time, pull off the power plug from the power socket and close the dishwasher door. Electric shock or short circuit may be caused due to the degradation of insulating material.
 Care about the door	<ul style="list-style-type: none"> The door shall keep close, to prevent stumble. It is very dangerous to open the door during washing, and hot water may cause scald.
 Care for safety	<ul style="list-style-type: none"> When install the items (dishes, utensils etc) into the dishwasher: <ol style="list-style-type: none"> Be careful to put sharp utensil to prevent it from scratch the door sealing strip. Warning: the cutters and other sharp tools must be put in the basket, and the sharp end is put downwards or horizontally.
 Care for cleaning	<ul style="list-style-type: none"> Moisten the soft cloth by mild cleaning solution, then wipe the machine, and wipe it dry by dry cloth.
 Attention	<ul style="list-style-type: none"> After washing, check if the dishwashing powder is empties. Firstly, confirm that there is no error or abnormality notification on the panel before using the dishwasher. When installing the dishwasher, use new water hose. Do not use the current water hose. Maximum inlet water pressure is 1 MPa. Minimum water inlet pressure is 0.04 MPa.

 Loading capacity	<ul style="list-style-type: none"> ● 109 pcs (Glass *8 + Rice bowl *15 +Condiment dish *8 + Mug *7 + Deep plate *7 + Shallow plate *8 + Soup bowl *1 + Noodles bowl *7 + Fish plate *1 + Soup spoon *1 + Spoon *15 +Chopstick *30 + Rice spoon *1)
 Prohibit	<ul style="list-style-type: none"> ● Do not strongly push open door and main body, nor put the downward pressure to the door. Falling may cause injuries.
 Attention to pinching of fingers	<ul style="list-style-type: none"> ● Be careful not to pinch fingers when opening and closing the door. There is a risk of getting hurt while pinching fingers.
 Prohibit	<ul style="list-style-type: none"> ● Do not get close to the exhaust port. Steam or hot air may cause the burns.
 Attention to burn	<ul style="list-style-type: none"> ● While using or after using the dishwasher, pay attention to hot water drained out. High temperature hot water may come out, there is a risk of burns.
 Prohibit	<ul style="list-style-type: none"> ● Prohibit to hit or tap the dishwasher. Electric shock, electric leakage short circuit may cause fire.
 Instruction	<ul style="list-style-type: none"> ● Set the filters correctly. Residues clogs, causing breakdown.
 Prohibit	<ul style="list-style-type: none"> ● Do not put light and small dishes such as plastic containers. If it is dropped by water pressure of the water spray, it may cause malfunction due to clogging the dishwasher.
 Prohibit	<ul style="list-style-type: none"> ● Do not use for purposes other than dishwasher dryer. It may cause a malfunction.
 Instruction	<ul style="list-style-type: none"> ● Make the main unit a solid level surface. Normal operation may not be possible. It may cause water leakage.
 Instruction	<ul style="list-style-type: none"> ● Fix the connection of drainage pipe certainly. It may cause water leakage.

Treatments

- Handle the package of the dishwasher with extreme care.
- All packages are recyclables.
- Plastic parts are marked with abbreviation of international standard;



PE	Polyethylene, e.g., tableted package material
PS	Polystyrene, e.g., packing material
POM	Polyacetal or polyox, e.g., plastic clip
ABS	Acrylonitrile Butadiene Styrene , e.g., control panel
PP	Polypropylene, e.g., inner wall

Warning

- The packing material may be dangerous to children!
- The disposal of package and machine shall be submitted to the recycle center.
- When the machine is not in service, please switch off the power and close the machine door.
- The cardboard package is made by recycled paper and shall be collected for recycling.
- If the generated rubbish cannot be treated properly, they will be harmful to the environment and human health, and they shall be properly disposed to prevent potential threat.



Warning

- For more details of product recycle, please contact relevant departments of local government or the service center for domestic refuse management.
- Treatment: Please do not treat the product as unclassified municipal refuses. Different refuses have to be subject to special treatment separately.

Such warning sign is used to prevent dangers to you and others.
Please follow it strictly.
After reading, please store it properly for use just in case.

Contents

Please carefully read the instruction manual before using the dishwasher, and this is helpful for the use and maintenance of the product.

01 Recognize the dishwasher

Dishwasher features	10
Control panel	11

02 Program Setting

Washing program	14
Start up	16
Changing the program mid-cycle	16
Energy save	16
Put additional dishes in	17
End of washing program	17

03 Use the dishwasher

Water softener	18
Adding salt to the softener	19
Function of the rinse aid and detergent	20
Adding rinse aid to the dispenser	21
Adding detergent to the dispenser	22
Install dishwasher bowl basket	23

04 Cleaning and care

Filter cleaning	26
Spray arms cleaning	27
Care and maintenance	28

05 Installation

Product dimension	29
Power connection	30
Water Supply And Drain	31
Connection of drain hoses	32

06 Troubleshooting

Before connecting customer service center	33
Error code	35
Availability of spare parts	35
Specification	36

Recognize the dishwasher

Important:

Before using the dishwasher for the first time, read following instructions to ensure the best results.

Dishwasher features

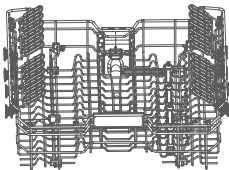
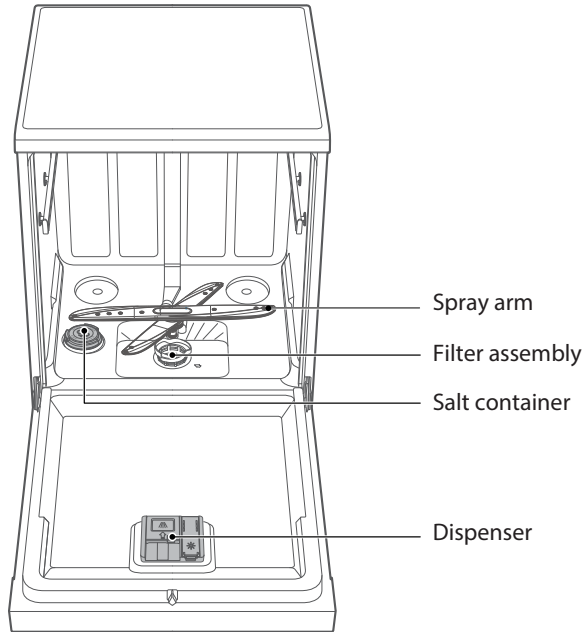

Upper basket

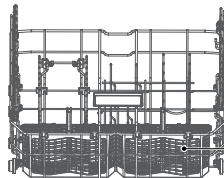





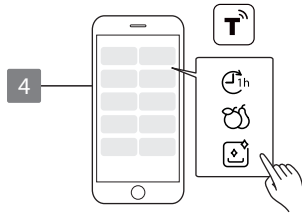
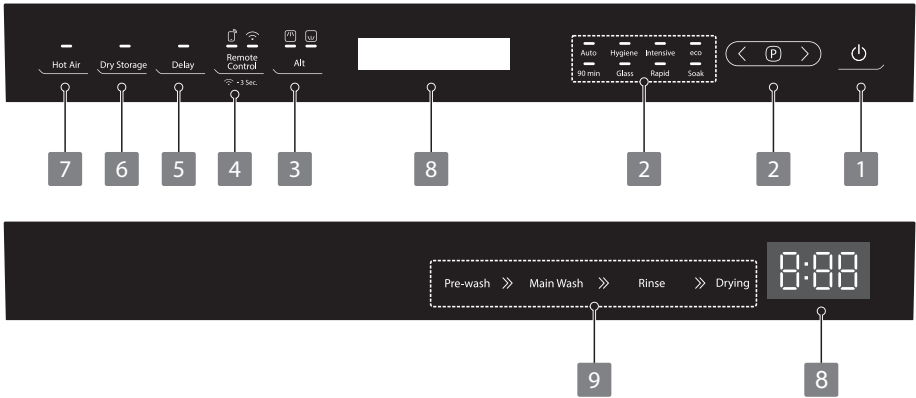

Lower basket





Cutlery basket

Control panel



1	Power Press this button to turn on the dishwasher.				
2	<p>Program</p> <p> < Select the corresponding washing program, press the button to backward. > Select the corresponding washing program, press the button to forward. </p> <p>Select the appropriate washing program and the corresponding indicator will light up.</p> <table border="0"> <tr> <td data-bbox="302 1241 492 1279">Auto</td> <td data-bbox="504 1241 1019 1305">For lightly, normally or heavily soiled crockery with or without dried-on food.</td> </tr> <tr> <td data-bbox="302 1311 492 1350">Hygiene</td> <td data-bbox="504 1311 1019 1375">Use to remove bacteria your dishes and glassware. Maintains the water temperature at 72°C.</td> </tr> </table>	Auto	For lightly, normally or heavily soiled crockery with or without dried-on food.	Hygiene	Use to remove bacteria your dishes and glassware. Maintains the water temperature at 72°C.
Auto	For lightly, normally or heavily soiled crockery with or without dried-on food.				
Hygiene	Use to remove bacteria your dishes and glassware. Maintains the water temperature at 72°C.				

<p>2 Program</p>	<p>Intensive For heavily soiled items include pots and pans. With dried on food.</p> <p>eco This is standard program. For general dirty dishes and utensils (such as pots, plates, glasses, pans).</p> <p>90 min For normally soiled loads that need quick wash.</p> <p>Glass For lightly soiled crockery and glass.</p> <p>Rapid For slight dirty dishes, the required cleaning time is relatively short.</p> <p>Soak To rinse dishes that you plan to wash later that day.</p> <p>These washing programs that can be selected in the APP:</p> <p> 1 hour For normally soiled loads that need 1 hour wash.</p> <p> Fruit wash Used to clean fruits, vegetables, shells, etc. This program need to set the water level and strength.</p> <p> Self clean This program provides an effective cleaning of the dishwasher itself.</p>
<p>3 Alt</p>	<p> Upper When you select Upper, only the dishes in the upper rack will be washed. The spray system of the lower basket will not operate.</p> <p> Lower When you select Lower, only the dishes in the lower rack will be washed. The spray system of the upper basket will not operate.</p>
<p>4 Remote Control/ Connect</p>	<p> The remote control function is used with the wireless function, and can only be used after your dishwasher is connected successfully. When you need to use the APP to control your dishwasher, you need to press the "Remote" button, and then close the door immediately. Tips: *In order to use the dishwasher more safely, you need to press the "Remote" button before each remote operation and close the door within 3 seconds. *When the door of the dishwasher is opened, the remote control function will fail. You need to complete the above operations again before you can use the APP remote operation.</p> <p> Press the button for more than 3 seconds. After a shout bleeping and the icon starts to blink slowly, it's in the network linking status to APP. Slowly flashing shows DW is waiting for connection. Quickly flashing shows DW is connecting. Quickly flashing solid shows DW is connected to your wireless router.</p>

5 Delay	Press this button to set the delayed hours for washing. You can delay the start of washing up to 24 hours. One press on this button delays the start of washing by one hour.
6 Dry Storage	<p>The Dry Storage function can achieve better drying effect and keep the air inside the dishwasher fresh.</p> <p>The Dry Storage function is carried out after the dishwasher has finished washing, and it can run for up to 72 hours.</p> <p>When you select Rapid, Soak or Fruit Wash, you cannot use the Dry Storage function.</p>
7 Hot Air	<p>An independent drying function with 3 modes, to Fresh, Warm and Dry your kitchenware. 25mins Fresh & Dry Blow fresh air into the tub for a daily freshness of your dishwasher.</p> <p>50mins Warm & Dry This function can have your dishware properly warmed, it is suitable for use before meals. Warm plates is more suitable for your just finished cooking.</p> <p>80mins Rinse & Dry Recommend running it once for Long-time-no-use Dishes after Vacation or Before Dinner Party. 80mins Rinse & Dry washes the dust particles away and gets the dishes well heated, to let them thoroughly dry again.</p>
8 Screen	<p> If the "☀" indicator is lit, it means the dishwasher is low on dishwasher rinse aid and requires a refill.</p> <p> If the "☹" indicator is lit, it means the dishwasher is low on dishwasher salt and requires a refill.</p> <p> If the "☹" indicator is lit, it means the water faucet closed.</p> <p> To show the remaining program time and delay time, error code etc.</p>
9 Progress indicators	To show the current washing stage.

Program Setting

Washing program

Following table shows best cleaning procedures and amount of dishwashing powder required according to the dirty level of the dishes, as well as the corresponding power and water consumption.

(●) indicates that the program uses rinse aid in the last rinse.

Program	Description Of Cycle	Detergent Pre/Main Wash	Running Time(min)	Energy (kWh)	Water (L)	Rinse Aid
Auto	Prewash(45°C) Auto wash(50-55°C) Rinse Rinse(72 °C) Drying	$\frac{5}{28.75}$ 1 or 2	115-195	1.150-1.550	12.1-19.4	●
Hygiene	Wash(65°C) Rinse Rinse(72°C) Drying	$\frac{5}{28.75}$ 1 or 2	150	2.965	11.9	●
Intensive	Prewash(50°C) Wash(70 °C) Rinse(60°C) Rinse(60°C) Rinse(72°C) Drying	$\frac{5}{28.75}$ 1 or 2	160	1.905	20.9	●
eco	Wash(47°C) Rinse Rinse(50°C) Drying	$\frac{5}{28.75}$ 1 or 2	235	0.835	10.5	●
90 min	Prewash (25°C) Wash(50°C) Rinse(45°C) Rinse(65°C) Drying	$\frac{5}{28.75}$ 1 or 2	90	1.079	14.2	●
Glass	Wash(55°C) Rinse(50°C) Rinse(45°C) Rinse(60°C) Drying	$\frac{5}{28.75}$ 1 or 2	130	1.265	15.2	●
Rapid	Wash(45°C) Rinse Rinse(45°C)	$\frac{25}{1 \text{ piece}}$	29	0.565	12	○

Program	Description Of Cycle	Detergent Pre/Main Wash	Running Time(min)	Energy (kWh)	Water (L)	Rinse Aid
Soak	Prewash	-	15	0.025	4.6	○
1 hour	Wash(50°C) Rinse(45°C) Rinse(60°C) Drying	<u>5/28.75</u> 1 or 2	60	0.899	11.7	●
Fruit wash	Wash (36°C) Rinse(45°C)	/	15	0.025	6.8	○
	Wash (Cold water) Rinse (Cold water)	/	10	0.025	6.8	○
Self clean	Wash(70°C) Rinse(55°C) Rinse(50°C) Rinse(72°C) Drying	<u>5/28.75</u> 1 or 2	135	1.695	15.2	●

Attention

The above program data is for reference only. Test conditions are as follows:

- Washing capacity: 105 pcs (Glass x8 + Rice bowl x15 + Soup spoon x1 + Rice Spoon x1 + Soup Bowl x1 + Fish Plate x1+Condiment Dish x8 + Mug x7 + Noodles Bowl x7 + Plate x7+ Spoon x15 + Chopsticks x30)
- Power consumption at shutdown state and standby state similarly are 1.00 W.

Start up

1. The plug shall be firstly plugged into the socket. Power supply shall be of 220-240V AC 50Hz type, with socket of 10 A 220-240V AC.
2. Make sure that the water supply is turned on to full pressure.
3. Open the door, switch on the appliance.
4. Press the button of desired program, the corresponding indicator will light up.
5. Close the door to start.

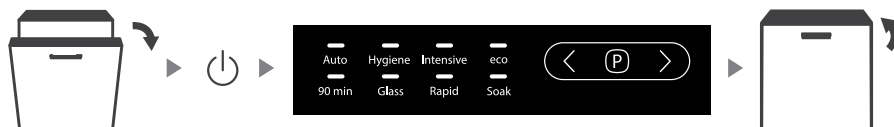

Changing the program mid-cycle

A wash cycle can only be changed if it has been running for a short time otherwise, the detergent may have already been released and the dishwasher may have already drained the wash water. If this is the case, the dishwasher needs to be reset and the detergent dispenser must be refilled. To reset the dishwasher, follow the instructions below:

1. Open the door a little to stop the dishwasher, after the spray arm stop working, you can open the door completely.
2. Press the ">" button for more than 3 seconds, the dishwasher will enter standby mode.
3. Press the Program buttons to select the desired program.
4. Then, close the door, the dishwasher will start its cycle.

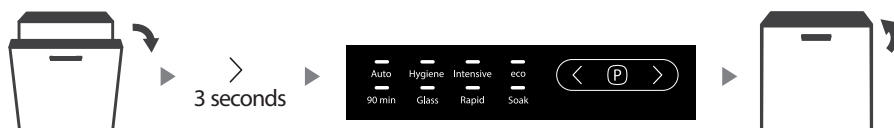

Energy save

1. Pre-rinsing of tableware items leads to increased water and energy consumption and is not recommended.
2. Washing tableware in a household dishwasher usually consumes less energy and water in the use phase than hand dishwashing when the household dishwasher is used according to the instructions.

Put additional dishes in

Additional dishes can be placed in at any time before dishwasher program start. If you want to reload dishes in the process of washing, please follow instructions below:

1. Open the door a little to stop the dishwasher, after the spray arm stop working, you can open the door completely.
2. Put the additional dishes in.
3. Close the door, the dishwasher will start after 10 seconds.

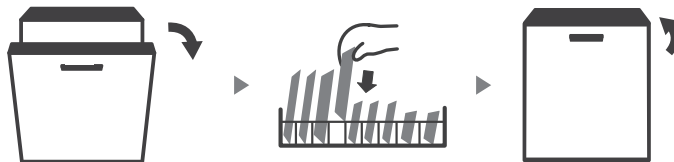

End of washing program

After the program finishes, the machine show "End" after the buzzer beeps for 8 seconds.

- Open the door carefully

Hot dishes are more likely to be damaged. The dishes shall be cool for about 15 minutes and then taken out from the dishwasher.

- Clear the dishwasher

It is normal that the dishwasher still remains wet inside.

Warning

It is extremely emely dangerous to open the door in the process of washing as this may cause severe burn by hot water.

Use the dishwasher

Water softener

The water softener must be set manually, using the water hardness dial.

The water softener is designed to remove minerals and salts from the water, which would have a detrimental or adverse effect on the operation of the appliance.

The more minerals there are, the harder your water is.

The softener should be adjusted according to the hardness of the water in your area. Your local Water Authority can advise you on the hardness of the water in your area.

Adjusting salt consumption

The dishwasher is designed to allow for adjustment in the amount of salt consumed based on the hardness of the water used. This is intended to optimise and customise the level of salt consumption.

Please follow the steps below for adjustment in salt consumption.

1. Open the door, switch on the appliance.
2. Press the > button for more than 5 seconds, when the salt indicator flashes means entering the water softener settings.
You must set model within 60 seconds after the appliance was switched on.
3. Press the > button to select the proper set according to your local environment, the sets will change in the following sequence:
H3->H4->H5->H6->H1->H2.
4. Without any operation in five seconds, the machine will exit from set mode, the machine is into standby status.

WATER HARDNESS				Water softener level	Regeneration occurs every X programme sequence)	Salt consumption (gram/cycle)
German °dH	French fH	British °Clarke	Mmol/l			
0 - 5	0 - 9	0 - 6	0 - 0.94	H1	No regeneration	0
6 - 11	10 - 20	7 - 14	1.0 - 2.0	H2	10	9
12 - 17	21 - 30	15 - 21	2.1 - 3.0	H3	5	12
18 - 22	31 - 40	22 - 28	3.1 - 4.0	H4	3	20
23 - 34	41 - 60	29 - 42	4.1 - 6.0	H5	2	30
35 - 55	61 - 98	43 - 69	6.1 - 9.8	H6	1	60

1 °dH=1.25 °Clarke=1.78 °fH=0.178mmol/l

The factory setting: H3

Every cycle with a regeneration operation consumes additional 2.0 litres of water , the energy consumption increases by 0.02kWh and the programme extents by 4 minutes

Adding salt to the softener

⚠ Warning

- **Only use salt specifically designed for dishwashers use!**

Every other type of salt not specifically designed for dishwasher use, especially table salt, will damage the water softener. In case of damages caused by the use of unsuitable salt the manufacturer does not give any warranty nor is liable for any damages caused.

- **Only fill with salt before running a cycle.**

This will prevent any grains of salt or salty water, which may have been spilled, remaining on the bottom of the machine for any period of time, which may cause corrosion.

Please follow the steps below for adding dishwasher salt:

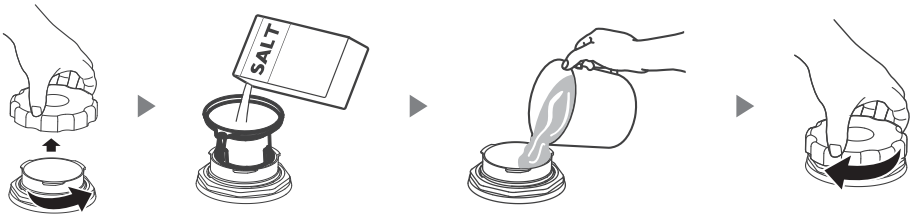

1. Remove the lower basket and unscrew the reservoir cap.
2. Place the end of the funnel (supplied) into the hole and pour in about 1.5kg of dishwasher salt.
3. Fill the salt container to its maximum limit with water, It is normal for a small amount of water to come out of the salt container.
4. After filling the container, screw back the cap tightly.
5. The salt warning light will stop being after the salt container has been filled with salt.
6. Immediately after filling the salt into the salt container, a washing program should be started (We suggest to use a short program). Otherwise the filter system, pump or other important parts of the machine may be damaged by salty water. This is out of warranty.

⚠ Attention

- The salt container must only be refilled when the salt warning light () in the control panel comes on. Depending on how well the salt dissolves, the salt warning light may still be on even though the salt container is filled. If there is no salt warning light in the control panel (for some Models), you can estimate when to fill the salt into the softener by the cycles that the dishwasher has run.
- If salt has spilled, run a soak or quick program to remove it.

Function of the rinse aid and detergent

The rinse aid is released during the final rinse to prevent water from forming droplets on your dishes, which can leave spots and streaks. It also improves drying by allowing water to roll off the dishes. Your dishwasher is designed to use liquid rinse aids.

⚠ WARNING

Only use branded rinse aid for dishwasher. Never fill the rinse aid dispenser with any other substances (e.g. Dishwasher cleaning agent, liquid detergent). This would damage the appliance.

When to refill the rinse aid

The regularity of the dispenser needing to be refilled depends on how often dishes are washed and the rinse aid setting used.

- The Low Rinse Aid indicator () will be lit when more rinse aid is needed.
- Do not overfill the rinse aid dispenser.

Function of detergent

The chemical ingredients that compose the detergent are necessary to remove, crush and dispense all dirt out of the dishwasher. Most of the commercial quality detergents are suitable for this purpose.

⚠ WARNING

- Proper Use of Detergent

Use only detergent specifically made for dishwashers use. Keep your detergent fresh and dry.

Don't put powdered detergent into the dispenser until you are ready to wash dishes.



- Dishwasher detergent is corrosive! Keep dishwasher detergent out of the reach of children.

Adding rinse aid to the dispenser

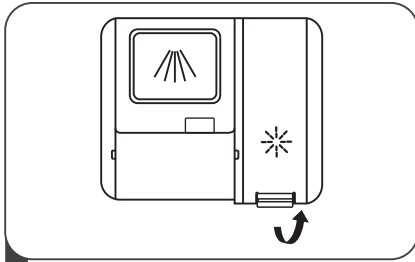

- 1 Remove the rinse reservoir cap by lifting up the handle .

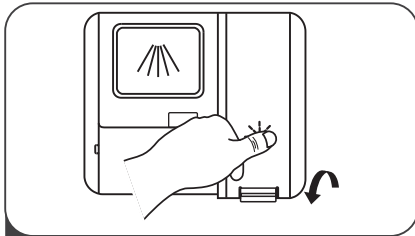

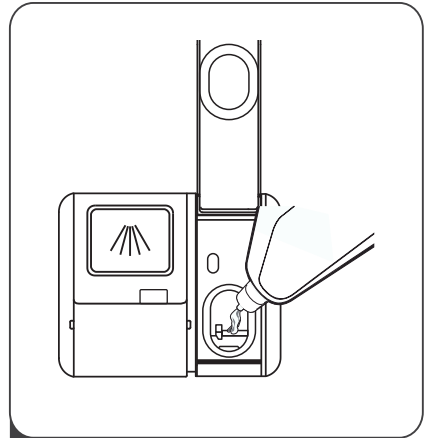

- 3 Close the cap after all.



- 2 Pour the rinse aid into the dispenser, being careful not to overfill.

Adjusting the rinse aid reservoir

To achieve a better drying performance with limited rinse aid, the dishwasher is designed to adjust the consumption by user. Follow the below steps.

1. Open the door and switch on the appliance.
2. Within 60 seconds after step 1, press the  button more than 5 seconds, and then press the Delay button to enter the set model, the rinse aid indication  blinks as 1Hz frequency.
3. Press the  button to select the proper set according to your using habits, the sets will change in the following sequence: D1->D2->D3->D4->D5->D1. The higher the number, the more rinse aid the dishwasher uses.
4. Without operation in 5 seconds or press the Power button to complete the setup and exit the setup mode.

Adding detergent to the dispenser

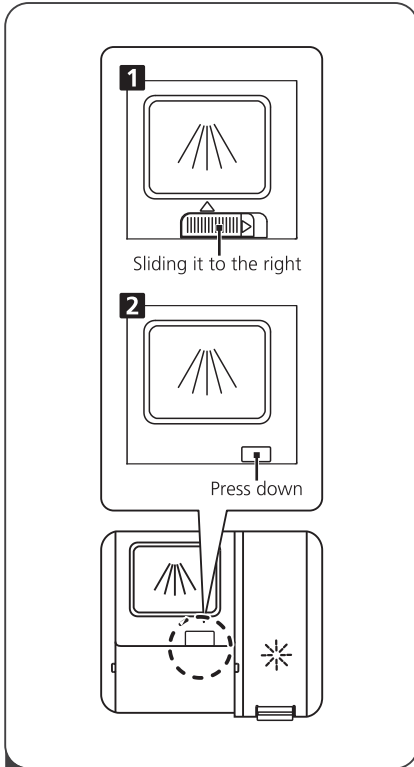

1 Please choose an open way according to the actual situation.

- 1. Open the cap by sliding the release catch.**
- 2. Open the cap by pressing down the release catch.**

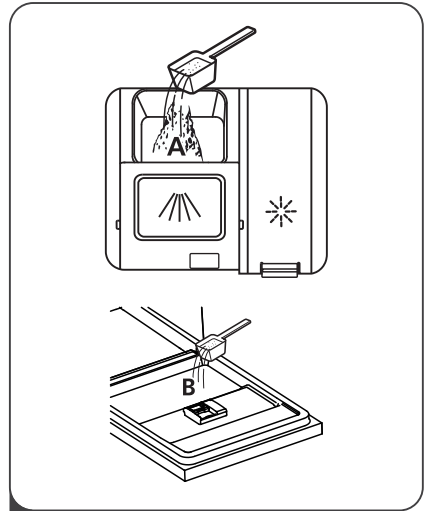

- 2** Add detergent into the larger cavity (A) for the main wash cycle . For better cleaning result, especially if you have very dirt items, pour a small amount of detergent onto the door. The additional detergent will activate during the pre-wash phase.

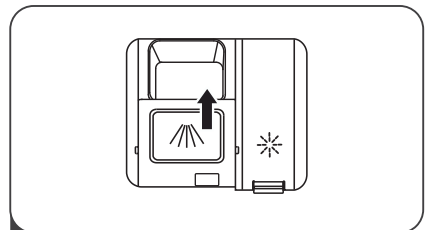

- 3** Close the flap by sliding it to the front and then pressing it down.

NOTE:

- Be aware that depending on the soiling of water, setting may be different.
- Please observe the manufacturer's recommendations on the detergent packaging.

Install dishwasher bowl basket

Suggestion

- Purchase dishes suitable for dishwasher.
- Use a suitable mild dishwashing powder. If necessary, consult the manufacturer for more information.
- For special appliances, try to select a washing program that with a lower temperature.
- Do not take out the glass dishes immediately after the program ends to prevent damage.

Use the dishwashing machine rationally

Not for:

- Wooden, ivory, porcelain or pearl shank tool
- Non heat-resistant plastic products
- Stale non heat-resistant cutters with glue adhesive part
- Cohesive knives or dishes
- Tin or copper vessels
- Crystal glass
- Rusty steel products
- Wooden utensils
- Synthetic fiber products

Limited use:

- After several cleanings, some glassware will become dull
- Silver or aluminum products tend to change color during cleaning
- Color of smooth dishes may fade out if often washed

Precautions before and after the bowl basket is placed

(For the best use of dishwasher, follow the instructions below. For different models, the characteristics and appearance of the basket will be different) Clear larger food residues. Soften the residue of burnt food left on the pan. It is not necessary to rinse dishes with water first. Place the dishes in the dishwasher as follows:

- Cups, glasses, pots and so on are placed face down.
- For curved or concave and convex vessels, place them diagonally so that the water flows out.
- All utensils should be placed safely and must not be overturned.
- All utensils should be placed that the arms can rotate freely during washing.

Attention

For small objects, it is easy to fall out from the basket, which should not be placed in the dishwasher.

- The open of hollow tablewares (such as cups, glasses, pots, etc.) should face downward so that water does not easily remain in the container or grooves.
- Dishes and knives should not be placed in other utensils, and they can't overlaid each other.
- Do not place glass close to each other to avoid damage.
- For long knives, placing upright is very dangerous.
- Long or sharp knives (eg. meat cleavers) should be placed horizontally in the basket.
- Do not use the dishwasher overloaded so that you can get better cleaning performance.

Loading the dishwasher to its full capacity will contribute to energy and water savings.

Loading the upper basket

Use the upper rack for small or delicate items such as small plates, cups, saucers, glasses.

- Place items so that the open end faces down for cleaning and drying.
- Do not stack items on top of each other.

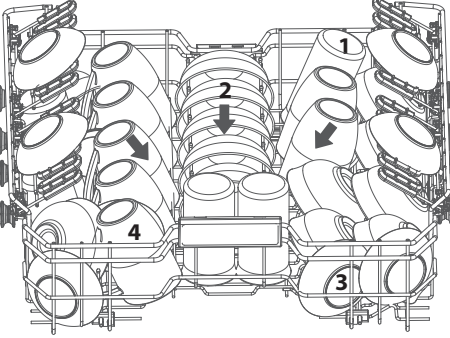

Number	Item
1	Glass
2	Rice bowl
3	Condiment dish
4	Mug

Chopsticks Spoon Basket

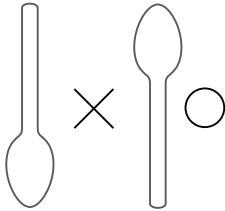

The handle of the cutlery should be facing down. When placing sharp cutlery, please be careful to scratch it.

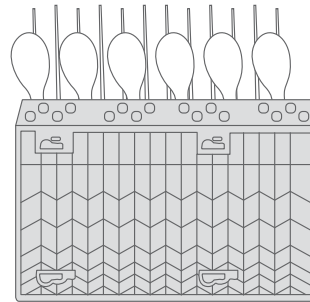

2. Lower basket placement

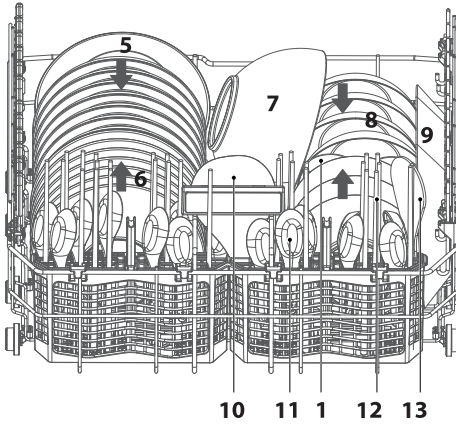

Number	Item
5	Deep plate
6	Shallow plate
7	Soup bowl
8	Noodles bowl
9	Fish plate
10	Soup spoon
11	Spoon
12	Chopstick
13	Rice spoon

⚠ Attention

In order to prevent the connection between the upper basket and the inner water pipe is not in place, which can cause low water pressure of the upper spray arm. After the upper basket is loaded with tableware, please make sure to push the upper basket until there is obvious resistance and then stop pushing.

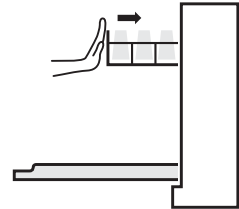

Cleaning and care

Filter cleaning

The filtering system in the base of the wash cabinet retains coarse debris from the washing cycle, including foreign objects such as tooth picks or shards. The collected coarse debris may cause the filters to clog. Check the condition of the filters regularly, carefully remove foreign objects and clean the parts of the filtering system if necessary under running water. Follow the steps below to clean the filters in the wash cabinet.

⚠ Warning

- Do not over tighten the filters. Put the filters back in sequence securely, otherwise coarse debris could get into the system and cause a blockage.
- Never use the dishwasher without filters in place. Improper replacement of the filter may reduce the performance level of the appliance and damage dishes and utensils.

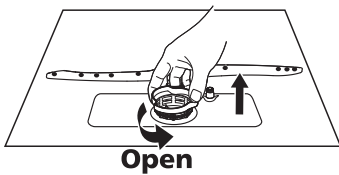

- 1** Hold the coarse filter and rotate it anticlockwise to unlock the filter. Lift the filter upwards and out of the dishwasher.

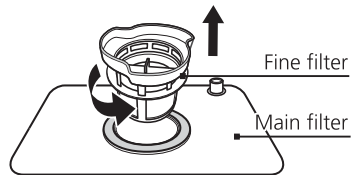

- 2** Lift fine filter up from main filter.



- 3** Larger food remnants can be cleaned by rinsing the filter under running water. For a more thorough clean, use a soft cleaning brush.

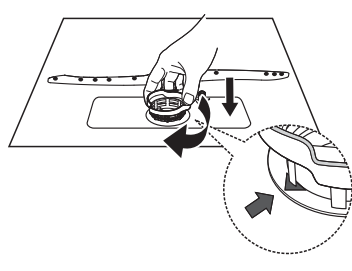

- 4** Reassemble the filters in the reverse order of the disassembly, replace the filter insert, and rotate clockwise to the close arrow.

Spray arms cleaning

It is necessary to clean the spray arms regularly for hard water chemicals will clog the spray arm jets and bearings.

To clean the spray arms, follow the instructions below:

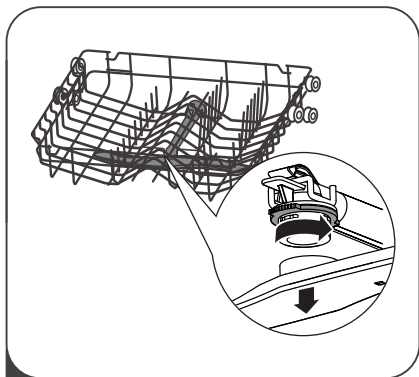

- 1 To remove the upper spray arm, hold the nut in the center still and rotate the spray arm counterclockwise to remove it.

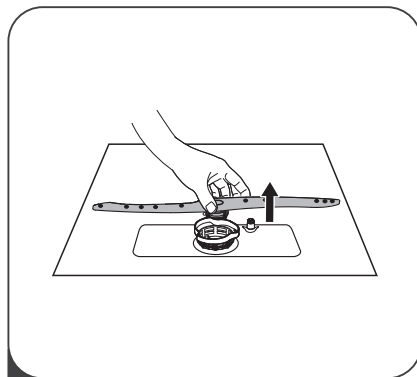

- 2 To remove the lower spray arm, pull out the spray arm upward.

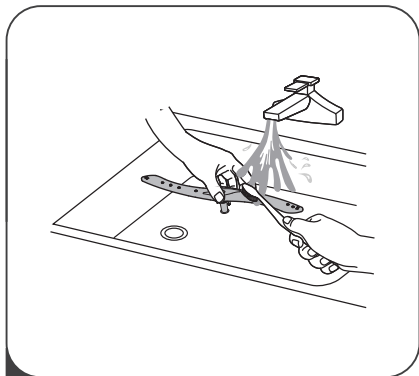

- 3 Wash the arms in soapy and warm water and use a soft brush to clean the jets. Replace them after rinsing them thoroughly.

Care and maintenance

The door and the door seal

Clean the door seals regularly with a soft damp cloth to remove food deposits. When the dishwasher is being loaded, food and drink residues may drip onto the sides of the dishwasher door. These surfaces are outside the wash cabinet and are not accessed by water from the spray arms. Any deposits should be wiped off before the door is closed.

The control panel

Control panel can be wiped with a slightly wet cloth. After cleaning, make sure it is completely dry.
Do not use Sharp tools, Scratch sponge, or Rough detergent anywhere in the machine.

Warning

- Do not use spray detergent to clean the door, as it may damage the door lock and other electrical components.
- Do not use abrasives or rough paper towels, as it may leave scratches or spots on stainless steel surface.

Installation

Product dimension

The following figure shows the dimensions of the product in millimeters.

You can adjust the height of the product through the height of the bottom adjusting rod.

You can remove the top plate to lower the height of the product to match your cabinet.

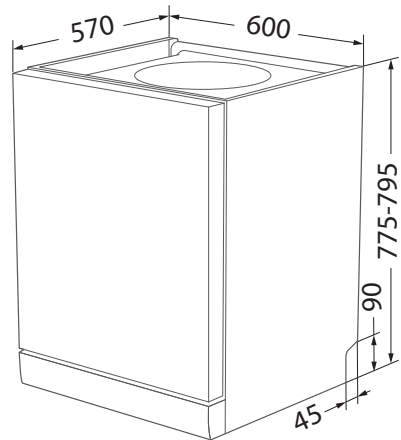
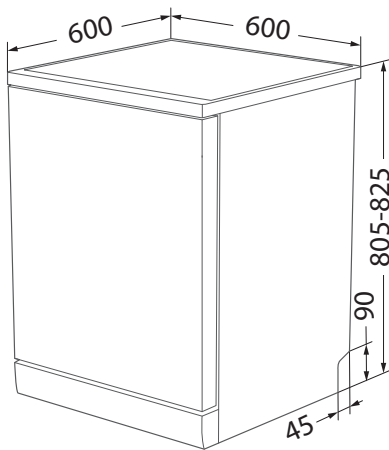

Warning



Electric Shock

The machine shall be installed after the power is off. If not, electric shock or death can be caused.

Please make sure the machine is properly grounded before use.

Power connection

Warning

Electric Shock

- Do not use an extension cord or power adapter on this machine.
- In case, do not cut off or remove the grounding connection of power cord.

Power requirements

Please check the label of rated value of power supply system for knowing rated voltage and connect the machine to appropriate power supply. 10A fuse is required and time-delay fuse or circuit breaker is recommended. Only separate circuit is suitable for this machine.

Machine connection

Make sure that supplied voltage and frequency correspond to those on rating plate. Plug can only be connected to a properly grounded socket. If the socket that the machine must be connected to is not suitable for the plug, replace the socket, and do not use a power adapter that may cause overheating and burning.

Grounding Instructions

This appliance must be earthed. In the event of a malfunction or breakdown, earthing will reduce the risk of electric shock by providing a path of least resistance for the electric current.

This appliance is equipped with a cord having an equipment-earthing conductor and an earthing plug. The plug must be plugged into an appropriate outlet that is installed and earthed in accordance with all local standards and requirements

Water Supply And Drain

Cold water connection

Connect the cold water supply hose to a threaded 3/4(inch) connector and make sure that it is fastened tightly in place. If the water pipes are new or have not been used for an extended period of time, let the water run to make sure that the water is clear. This precaution is needed to avoid the risk of the water inlet to be blocked and damage the appliance.

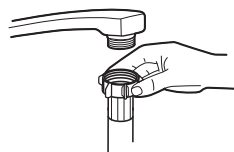

ordinary supply
hose



safety supply hose

About the safety supply hose

The safety supply hose consists of the double walls. The system guarantees its intervention by blocking the flow of water in case of the supply hose breaking and when the air space between the supply hose itself and the outer corrugated hose is full of water.

Warning

A hose that attaches to a tap can burst if it is installed on the same water line as the dishwasher. If your sink has one, it is recommended that the hose be disconnected and the hole plugged.

How to connect the safety supply hose

1. Pull the safety supply hoses out from storage compartment located at rear of dishwasher.
2. Tighten the screws of the safety supply hose to the faucet with thread 3/4inch.
3. Turn the water fully on before starting the dishwasher.

How to disconnect the safety supply hose

1. Turn off the water.
2. Unscrew the safety supply hose from the faucet.

Connection of drain hoses

Insert the drain hose into a drain pipe with a minimum diameter of 4 cm, or let it run into the sink, making sure to avoid bending or crimping it. The height of drain pipe must be less than 750 mm. The free end of the hose must not be immersed in water to avoid the back flow of it.

⚠ Please securely fix the drain hose in either position A or position B

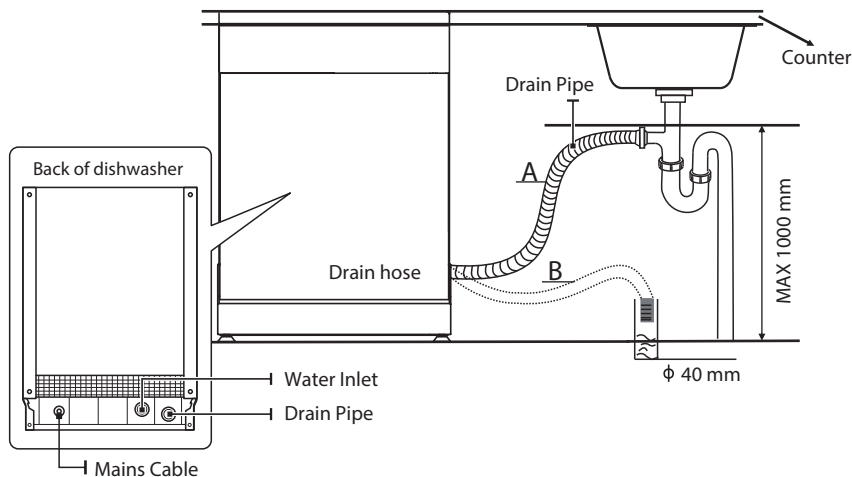

How to drain excess water from hoses

If the sink is 1000 higher from the floor, the excess water in hoses cannot be drained directly into the sink. It will be necessary to drain excess water from hoses into a bowl or suitable container that is held outside and lower than the sink.

Water outlet

Connect the water drain hose. The drain hose must be correctly fitted to avoid water leaks. Ensure that the water drain hose is not kinked or squashed.

Extension hose

If you need a drain hose extension, make sure to use a similar drain hose. It must be no longer than 4 meters; otherwise the cleaning effect of the dishwasher could be reduced.

Syphon connection

The waste connection must be at a height less than 100 cm (maximum) from the bottom of the dish. The water drain hose should be fixed.

Troubleshooting

Before connecting customer service center

Please check the chart below before connecting customer service center

Problem	Possible cause	Solutions
The machine is not working	Fuse burn-out or circuit trip.	Replace fuse or reset circuit breaker Remove any other appliances that share same circuit with the dishwasher.
	Power is not connected.	Make sure that dishwasher is on and the door is firmly closed. Make sure power cord is properly plugged into the socket.
	Door is open.	Close the door.
Insufficient drainage	Drainage pipe has a knot or is blocked.	Check the drainage pipe.
	Filter is blocked.	Check coarse filter.
	Sink drain is blocked.	Check the sink drain to ensure good drainage. If the kitchen sink drain is not working properly, you shall ask a pipe technician for help rather than a dishwasher qualified serviceman.
Foam remains in liner	Improper dishwashing powder is used.	In order to avoid foaming, only dishwashing powder specially designed for dishwasher can be used. In such case, open the door and allow the foam to evaporate. In case of too much foam, start any washing program for cleaning.
	Detergent overflows.	Wipe off spilled cleaner immediately.
Colors on liner	Use dishwashing powder with coloring agent.	Make sure that dishwashing powder used is free of coloring agent.
White film on liner	Hard water minerals.	Use wet sponge with dishwashing powder and wear rubber gloves for interior cleaning. Do not use any detergent other than dishwashing powder as it may generate foam or bubble.
Rust on dishes	Dishes with rust are easily to be corroded.	Avoid washing dishes that are easily to be corroded in dishwasher.
Crush in dishwasher	Dishes in the rack prevents spray arm from rotating.	Suspend the program and reposition the dishes that prevent spray arm from rotating.

Problem	Possible cause	Solutions
Noise from dishwasher	Dishes are loose.	Suspend the program and reposition the dishes.
Beats in water pipe	This may be caused by site installation or cross section	It has no effect on operation of dishwasher. In case of any doubts, please contact qualified pipe technician.
Dishes remain dirty after washing	Dishes are not placed correctly.	Please see "Loading the basket" information for details (Page 22).
	The program is not powerful enough.	Select a more powerful program.
	Dishwashing powder is not enough.	Use more dishwashing powder or replace new detergent.
	Placement of dishes affects the rotation of spray arm.	Reposition the dishes so that spray arm can rotate freely.
	Filter assembly is dirty or not properly installed on the base, which may impede the rotation of spray arm.	Clean or properly install the filter and clean spray arm.
Glassware is not glossy	Add too much dishwashing powder under soft water conditions.	If soft water is used, use less powder and select a shorter washing program to clean the glassware.
White point on dishes or glassware	Hard water produces more scale.	Add dishwashing powder.
Black or grey imprints on dishes	Friction between aluminum utensil and dishes.	Use mild detergent to eliminate these imprints.
Dishwashing powder remains in adding position	Placement of dishes hinders the addition of dishwashing powder.	Place the dishes correctly.
Dishes are not completely dry	Placement is improper.	Please see "Loading the basket" information for details (Page 22).
	Dishes are taken out too early.	Do not take dishes out immediately after the program ends. Slightly open the door let the vapor out and wait until dishes are cool.
	Program is wrong.	When shorter washing procedures are used, washing temperature is lower and cleaning effectiveness is reduced. A longer program shall be selected.
	The dishes have poor drainage ability.	These dishes have poor drainage ability, which are not suitable to be washed in dishwasher.

Error code

When failure occurs, error code will appear to remind you:

Error code	Code name	Possible cause
E1	Long water intake time	Flow-meters, drain valves, or pump failures shall be repaired by qualified serviceman.
E3	Abnormal heating	Heating pipe or thermistor is at abnormal state, which needs to be unplugged the power plug from the outlet , and needs to be repaired by qualified serviceman.
E4	Overflow or water tank problem	The machine occur overflow or something wrong with the floater in the water tank, needs to be repaired by qualified serviceman.

Warning

Self-repair or non-professional repair may cause serious risks to the safety of the user of the appliance and impact warranty.

Availability Of Spare Parts

- **Seven years after placing the last unit of the model on the market:**
Motor, circulation and drain pump, heaters and heating elements, including all heat pumps (separately or bundled), piping and related equipment including all hoses, valves, filters and aqua stops, structural and interior parts related to door assemblies (separately or bundled), printed circuit boards, electronic displays, pressure switches, thermostats and sensors, software and firmware including reset software.
- **Ten years after placing the last unit of the model on the market:**
Door hinge and seals, other seals, spray arms, drain filters, interior racks and plastic peripherals such as baskets and lids.

Specification

Model	DW-15F6(G)-MY
Dimension (mm)	600(W) x 805(H) x 600(D)
Rated voltage	220-240 V
Rated frequency	50 Hz
Rated power	1828-2158 W
Water consumption	10.5L
Power consumption	0.835 kWh
Control mode	Electronic type
Water-proofing grade	IPX1
Washing capacity	109 pcs (Glass *8 + Rice bowl *15 +Condiment dish *8 + Mug *7 + Deep plate *7 + Shallow plate *8 + Soup bowl *1 + Noodles bowl *7 + Fish plate *1 + Soup spoon *1 + Spoon *15 +Chopstick *30 + Rice spoon *1)
Total weight	53.2kg
Net weight	47.9kg

HOW TO CONNECT WITH TOSHIBA TSMARTLIFE APP

Before you start, make sure that:

1. Your smartphone is connected to home wireless network, and you know the network password.
2. You are next to the appliances.
3. The frequency of your wireless router is 2.4GHz (preferable) or 5GHz.
4. Initiate your mobile phone's Bluetooth and allows the APP to find your phone.

Download the TSmartLife app

On an app market (Google Play Store, Apple App Store), search for "TSmartLife" and find the TSmartLife app. Download and install it on your phone. You can also download the app by scanning the QR code below.



1. Download and install the app. Search for: TSmartLife in the mobile application market, download and install the APP.



Connect your devices to TSmartLife

1. Please make sure your mobile phone is connected to a wireless network. If not, go to Settings and turn on the wireless connection, select and connect to a wireless network. Also please turn on the Bluetooth on your phone. If not, go to Settings and turn it on.

1. Click on the APP icon to enter the APP.



4. Select region



2. Read and agree on the **Privacy Policy and Software License and User Service Agreement.**



5. Click the button of **Sign up>**.



3. Click the button of **Login.**



6. Enter email and send confirmation code.



HOW TO CONNECT WITH TOSHIBA TSMARTLIFE APP

7. Enter email and confirmation code. Agree on the **Privacy Policy and Software License and User Service Agreement**. Click the button of **Next**.



8. Set password. Then click the button of **submit**.



9. Enter the homepage. Click the button of **Add device**.



10. Long press  for 3 seconds, light flashes.



11. Select a device. Choose Dishwasher. Or click the Device that can be connected to jump to Step 13



12. Select model DW-16F(G)-MY
DW-16F(G)-SG
DW-16F(G)-TH



13. Choose the wireless network interface.



14. If you haven't authorized location before, please allow access in the settings the turn on the precise location. Click the button of **Go to setting**.



15. Enter **Setting** page. Click the button of **Location**.



HOW TO CONNECT WITH TOSHIBA TSMARTLIFE APP

16. Choose **While Using the App.**



17. Return back to the **TSmartLife.** Enter the wireless network password. Click the button of **Next.**



18. Wait for connecting.



19. Added successfully. Named it as your wish. Then click the button of **Done.**



20. Back to the homepage.



Note

- Make sure your devices are powered on.
- Keep your mobile phone close enough to your device when you are connecting your device to the network.
- Connect your mobile phone to the wireless network at home, and make sure you know the password of the wireless network.
- Check if your wireless router supports 2.4 GHz band and turn it on. If you are not sure whether the router supports 2.4 GHz band, please contact the router manufacturer.
- The device cannot connect to the wireless network that requires authentication, and it usually appears in public areas such as hotels, restaurants, etc. Please connect to a wireless network that does not require authentication.
- Turn on the WLAN+ (Android) or WLAN Assistant (iOS) function of your mobile phone when connecting your device to the network.
- In the case that your device connected to a wireless network before but it needs to reconnect, please click "+" on the app Home page, and add your device again by the device category and model according to the instructions on app.

INSTRUCTIONS TO FUNCTION WITH TSMARTLIFE APP

Application software operation interface

- 1 Click power on to enter the home page of Dishwasher

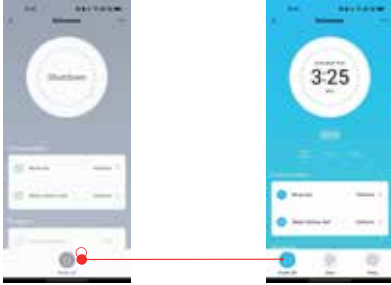

- 2 Click "Program Selection" to select the program, click "Confirm" to return to the main interface

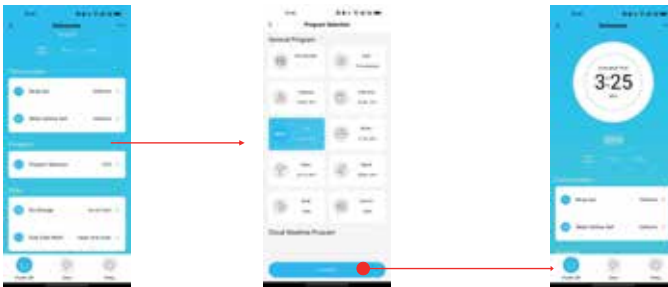

- 3 Slide the screen to the bottom, select the additional functions you need in "Additional", and click "Start" to start running after the selection is complete.



- 4 Click "Delay" to set delay start. After entering the next interface, click "Delay" again to select the startup time you want, click "Program Selection" to select the program you need, and you can also select additional functions. After setting, click "Confirm" to jump to the appointment interface. After setting, click "Confirm" to jump to the appointment interface, the device will enter the appointment countdown automatically. If you click start, the device will start the washing process directly.



- 5 Dry Storage. Click "Dry storage". Then slide up and down to select the time you need. Then click "Confirm" and the screen will jump to the "Stand by" interface. Click "Start" and the dishwasher will enter the "Dry storage" stage after washing.

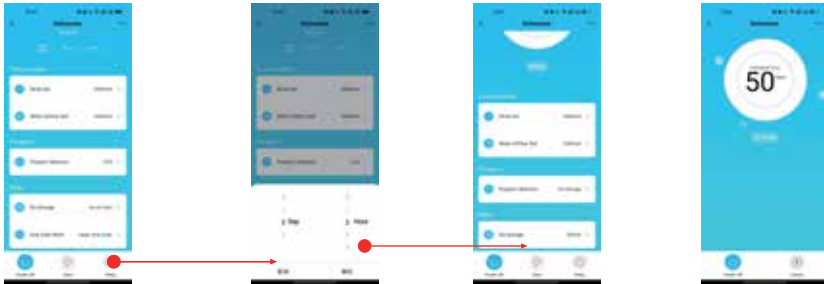

- 6 Dual Zone Wash. Click "Dual Zone Wash". Then slide up and down to select the area you want. Then click "Confirm" and the screen will jump to the "Stand by" interface. Click "Start" to start the dishwasher.



Toshiba TSmartLife Troubleshooting

Background :

Offering dual-band support provides choices and maximum flexibility of the product to have successful experience on home network.

Home networks can be expected to have multiple WiFi service

possibilities, depending on how their router is configured. There are four WiFi router configuration modes: A, B, C and D.

A. 2.4GHz only ... e.g. older model WiFi router

- o In this case dual band radio will automatically operate at 2.4GHz

B. 5GHz only ... some people may choose to turn off older 2.4GHz band due to conflicting interference

- o In this case dual band radio will automatically operate at 5GHz

C. 2.4GHz and 5GHz sharing same SSID name ... e.g. JohnsWiFi

- o In this case the WiFi router and dual-band radio will negotiate the best frequency to use

D. 2.4GHz and 5GHz with different SSID names ... e.g. JohnsWiFi_2G and JohnsWiFi_5G

- o In only this case is there a choice which WiFi band to use.

Having a dual band radio in the appliance means it is not necessary to change routers or router configuration unless problems are experienced, in which case knowing what WiFi router configuration you have (see above A, B, C or D) is important to know and understand.

Under this circumstance	Check · Cause
<p>If unable to join network at the first time</p>	<ul style="list-style-type: none"> ● Cannot see home SSID network: <ul style="list-style-type: none"> o Weak signal... Since appliance radio is dual-band this means neither 2.4GHz nor 5GHz signal is being received by the appliance. Just because the WiFi signal can be seen by the phone doesn't necessarily mean that the appliance radio can see it if the signal is marginal. Long distance between router and appliance or encountering too many barriers can reduce the signal level too much Reorienting the router may improve the situation slightly. A better solution would be a WiFi repeater or a higher quality router Recognize that all WiFi routers transmit power is limited by federal regulations, but a higher quality router can do a better job of transmitting the signal equally in all directions, have more sensitive receivers to better handle weak signals, and have higher quality software to minimize the dropping of connections. ● SSID network seen but cannot Join: <ul style="list-style-type: none"> o Networks requiring authentication ... often used with public networks at restaurants or hotels. Products cannot accept the legal agreement required to join the network. Please switch to a network that does not require authentication. o Insufficient encryption ... for cybersecurity reasons Toshiba does not recommend products to join non-encrypted or insufficiently encrypted networks (e.g. WEP encryption). o Password length... for cybersecurity reasons Toshiba recommends networks to have strong passwords, but the maximum password length supported is 32 characters. o Incorrect password ... If trying to join a different network than the one the phone is currently using, then it is always possible that the network password in the phone is no longer correct. In this case, new credentials will need to be provided. o Illegal SSID name ... TSmartLife App accepts any SSID name, but the App may issue warning when attempting to join network with certain non-alphanumeric or foreign language characters. ● WLAN+ (Android) or WLAN Assistant (iOS) functions are turned on, please turn off and reconnect to the Internet

Under this circumstance	Check · Cause
<p>If can join network but the connection is unstable</p>	<p>For WiFi configuration modes A, Band C, follow the instructions provided by your router manufacturer to make the indicated router configuration changes:</p> <ul style="list-style-type: none"> • In case of router configuration A (see above), Toshiba recommends enabling 5GHz band if it is disabled in your router and choosing a distinct SSID name for the 5GHz band (e.g. SSIDname_5G). Then follow the normal joining instructions to join the 5GHz network. If your router is an older 2.4GHz only router, Toshiba recommends upgrading to a newer dual-band router. • In case of router configuration B (see above), Toshiba recommends enabling 2.4GHz band (all routers that offer 5GHz also support 2.4GHz), and choose a distinct SSID name for the 2.4GHz band (e.g. SSIDname_2G). Then follow the normal joining instructions to join the 2.4GHz network. • In case of router configuration C (see above), Toshiba recommends assigning distinct SSID names for the 2.4GHz and 5GHz bands. Then follow the normal joining instructions to one of the networks, and subsequently follow the troubleshooting instructions for WiFi mode D. <p>For these steps router configuration changes are not required:</p> <ul style="list-style-type: none"> • In case of router configuration D (see above), then it is worthwhile to try operation on the other band before making changes to the router configuration or upgrading the router. In other words, if unstable connection using 2.4GHz then try 5GHz instead. Or if unstable connection using 5GHz then try 2.4GHz instead. Follow the instructions below "How to set the network to 2.4GHz or 5GHz." • WLAN+ (Android) or WLAN Assistant (10S) functions are turned on, please turn off and reconnect to the Internet.
<p>If your Device offline, check your connection status Please confirm that</p>	<ul style="list-style-type: none"> • Whether the device is properly powered • Whether the network signal is stable • Whether the WiFi name or password has been changed, if so, please add the device again

Operating frequency of product :

RF	Transmit frequency	Maximum transmit power
BLE	2402-2480MHz	<10dBm
2.4G WiFi	2412-2472MHz	<20dBm
5G WiFi(if have)	5180-5240MHz	<20dBm
	5260-5320MHz	

Note: The product is suitable to operating in the environment of 4~40℃