

型号
Model

GR-HG55MDZ
GR-HG52MDZ
GR-H55MBZ
GR-H52MBZ
GR-HG55SEDZ
GR-HG52SEDZ
GR-H55SEBZ
GR-H52SEBZ

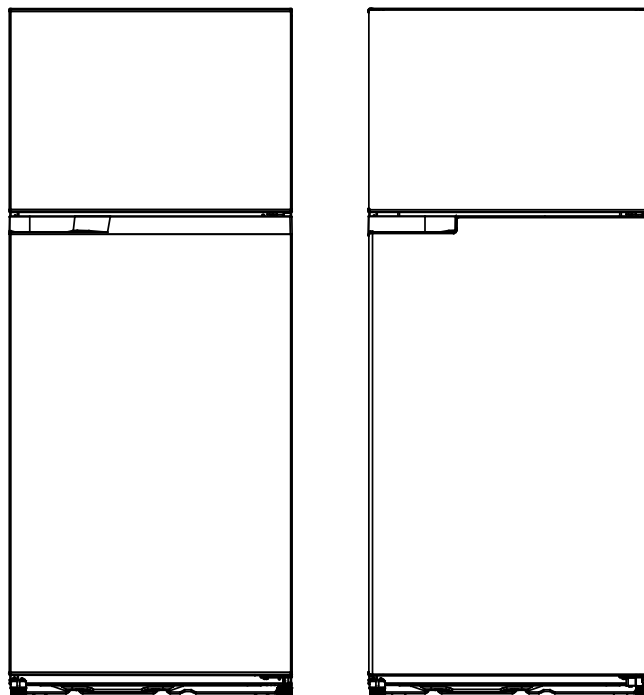



- 非常感谢您购买本东芝冰箱。
- 为了安全并正确使用本产品，请在使用前阅读本用户手册以充分了解本冰箱。
- 请妥善保存本用户手册，以备将来参考。
- 请确认您收到质保卡。
- Thank you very much for purchasing this Toshiba refrigerator.
- Read this Owner's Manual and become completely familiar with the refrigerator before use in order to use this product safely and correctly.
- Keep this Owner's Manual in a handy place for future reference.
- Make sure that you received your warranty.

安全指南

请仔细阅读并遵守下述指南。



- 这些指南是避免造成用户重大伤亡及财产损失的预防措施。

记号

-  **警告** 警告表示极有可能造成用户重大人身伤害 (*1) 甚至死亡。
-  **注意** 注意表示极有可能造成人身伤害 (*2) 或财产损失 (*3)。

- (*1) 重大人身伤害 - 需要住院、长期治疗, 或失明、皮肤烧烫伤、触电、骨折或中毒等人身伤害情形。
(*2) 人身伤害 - 不需要住院或长期治疗的受伤、皮肤烧伤或触电等人身伤害情形。
(*3) 财产损失 - 房屋、家具、家畜或宠物的延伸损失。

符号

-  **禁止!** 禁止! 表示被禁止的行为。
详细说明会用图形或文字标注在符号圈内或周边。
-  **重要** 重要 表示强制行为。
详细说明会用图形或文字标注在符号圈内或周边。
-  **注意** 注意 建议用户采取预防措施。
详细说明会用图形或文字标注在符号圈内或周边。

 异丁烷含有易燃制冷剂。
R600a : iso-butane



R600a

SAFETY INSTRUCTIONS

All instructions described should be carefully read and followed.



- These instructions are precautions to prevent the risks of serious injury or death of the user, and any damages to property.

MARKINGS

-  **WARNING** WARNING indicates high possibility of serious injury (*1) or death of the user.
-  **CAUTION** CAUTION indicates a high possibility of injury (*2) or property loss (*3).

- (*1) Serious injury – injury which requires hospitalization, lengthy treatment, or blindness, hot and cold skin burn, electric shock, broken bones or poisoning.
(*2) Injury – injury, skin burn or electric shock which does not require hospitalization or lengthy treatment.
(*3) Property loss – extended loss of houses, furniture, domestic animals or pets.

SYMBOLS

-  **PROHIBITED!** Indicates prohibited actions. Detailed instructions would be indicated on the inside of the circle or around the symbol in figures or in writing.
-  **IMPORTANT** Indicates mandatory actions. Detailed instructions would be indicated on the inside of the circle or around the symbol in figures or in writing.
-  **CAUTION** Recommends to take precautions. Detailed instructions would be indicated on the inside of the triangle or around the symbol in figures or in writing.

 This appliance contains flammable refrigerant.
R600a : iso-butane

R600a

警告

-  **警告** 规格: 仅连接至 220 - 240V. 电压。
直接连接至电源插座, 切勿使用复式插座。否则会引发火灾和触电事故。

-  **更换电源线** 若电器的电源线受损, 必须到制造商指定的维修店进行更换, 以避免安全隐患。

-  **禁止!** 为防止电源线或插头损坏或磨损, 不应在其上放置物体或将其夹住。
固定、弯曲、用重物挤压电缆和插头, 或将冰箱后板挤压到电缆和插头上, 会引发火灾或触电事故。

-  **拔下插头** 出现电器故障或损坏时, 请拔下插头断开电源。
若继续使用电器会导致火灾、触电、受伤或皮肤烧伤。
请联络经销商进行维修。

-  **握住插头断开电源** 断开电源时, 握住插头脱离插座。
捏住电源线端脱离插座会损坏导线绝缘性, 引发火灾和触电事故。

WARNING

-  **Specification: Only connect to main voltage 220 - 240V.**
Directly connect to the power socket, and do not use multiple sockets. This may cause fire and electric shock.

-  **Change the supply cord** If the supply cord of this appliance is damaged, it must only be replaced by a repair shop appointed by manufacturer, in order to avoid a hazard.

-  **Prohibited!** The power supply cord or plug should not be pressed or pinched by any objects in order to prevent any damages or fraying.
Binding, bending, pressing with heavy objects or applying pressure with the back panel of the refrigerator on the cord and plug may cause fire or electric shock.

-  **Disconnect plug** Disconnect power supply by unplugging the power plug in case of malfunction or breakdown.
Continued use of appliance may cause fire, electric shock, injury or skin burn.
Contact the distributor for service.

-  **Disconnect cord from plug** Disconnect power supply by unplugging from the power plug.
Unplugging from the supply cords may damage the wire insulation, which may cause fire and electric shock.

 **警告**



清洁时请断开电源连接。
否则会导致受伤和触电事故。插拔电源插头时请保持手的彻底干燥。



请定期清除电源插头上的灰尘。
电路连接不畅会导致火灾。



若电源线损坏或磨损，或电源插头连接松动，切勿使用。
这会引发火灾和触电事故。



请保持电器周边或内置结构的通风顺畅，清除通风障碍。
不要堵塞冰箱周围的空间。



为了安全考虑，使用前请务必将本机接地。
否则，一旦漏电，会导致火灾或触电事故。



请勿将冰箱安装在有水或特别潮湿的地方。
这会引发火灾和触电事故。



切勿在冰箱机身或内部洒水。
这会削弱电气绝缘性，引发火灾和触电。



切勿使用机械设备或用其它途径加速解冻程序，除非制造商建议如此操作。



切勿在冰箱的食品储藏格内使用电器，除非该电器属于制造商推荐的类型。
严禁在冰箱内使用其他电器。



切勿擅自拆卸

或维修。
否则会导致火灾、触电、受伤或皮肤烧伤。
操作说明中未涉及的一切维修应由有资质的维修人员进行操作。



切勿损坏制冷电路。



冰箱内部及背后的制冷系统含有液化石油气冷媒，严禁以任何尖锐物体接触制冷系统。



如果冰箱制冷系统遭到破坏并有气体泄漏，请不要使用附近任何电源插座和明火，应打开窗户让空气流通，并即时联络维修工人跟进。



本机不可由身体、感官或精神能力欠缺的人员（包括儿童）或缺乏经验和知识的人员来使用，除非是在负责安全的人员进行监督或指导的情况下使用本机。

 **WARNING**



Disconnect the power plug while cleaning.
May cause injury and electric shock. Dry your hands thoroughly before handling the power plug.



Clean and remove dust on power plug periodically.
Insufficient circuit connection may cause fire.



Do not use if the supply cord is damaged or frayed, or if the power plug has loose connection.
This may cause fire or electric shock.



Keep ventilation openings, in the appliance enclose or in the built-in structure, clear of obstruction.
Do not block the openings on the circumstances of the refrigerator.



For safety reason, always ensure grounding to the unit before use.
If you fail to comply, leakage of electricity may lead to fire or electric shock.



Do not install in a place where there's water or excess moisture.
This may cause fire or electric shock.



Do not sprinkle water to the body or the inside of the refrigerator.
This may weaken the electric insulation, which may lead to fire and electric shock.



Do not use mechanical devices or other means to accelerate the defrosting process, other than those recommended by the manufacturer.



Do not use electrical appliances inside the food storage compartments of the appliance, unless they are of the type recommended by the manufacturer.
Do not use other electric appliances inside the refrigerator.



Do not disassemble or attempt to service.
It may cause fire, electric shock, injury or skin burn. All services not described in operating instruction should be referred to qualified service personnel.



Do not damage the refrigerant circuit.



The refrigerator system behind and inside the refrigerator contains refrigerant. Do not allow any sharp objects to come into contact with the refrigeration system.



In case of having damaged the refrigerant circuit, do not use electric items or fire equipments nearby, and open all windows to provide good ventilation. Please also contact your local maintenance agent to follow up.



This appliance is not intended for use by persons (including or lack of experience and children) with reduced physical, sensory or mental capabilities, knowledge, unless they have been given supervision or instruction concerning use of the appliance by a person responsible for their safety.



警告



警告

应指导儿童以保证他们不将本机当作玩具。
请看管小孩，以确保冰箱恰当地使用。



禁止!

切勿悬吊或倚靠在冰箱门上。
否则冰箱可能会倾覆，冰箱门可能会脱离铰链，或者您的手会被卡在门内而受伤。



切勿存放

切勿存放易燃物品。
醚、苯、酒精、稀释剂、黏合剂、喷剂、液化石油气或任何化学制品可能会爆炸或引发事故。



切勿存放

切勿储存药品、化学制品或化学试剂。
本冰箱不适用于储存对温度敏感的物品。



禁止!

切勿在冰箱上放置任何重物或液体容器。
一旦溅落会影响电气绝缘，引发火灾或触电。
物体掉落会导致人员受伤。



切勿食用
变质食品

切勿食用已变色或有异味的食品。
这些食品会导致食物中毒或疾病。



废弃方法

废弃冰箱时
● 切勿将其遗留在儿童玩耍的地方。
● 为防止儿童躲进冰箱内无法出来的危险，请将冰箱门封条拆除，使冰箱门无法密封关闭。
● 请联系环境保护单位处理废弃发泡层。



警告

警告标签和铭牌必须一直牢固张贴于压缩机和冰箱上。使用说明书须有效保管，如果冰箱要搬运到另一地方或回收，使用说明书亦应与冰箱一并交给处理和运送的人士。



WARNING



Warning

Children should be supervised to ensure that they do not play with the appliance.

Children should be supervised to ensure that the refrigerator should be used properly.



Prohibited!

Do not hang or stand on the door.
It may overturn, The door may come off the hinges, or you may catch your fingers in the door which may cause injury.



Do not store

Do not store the flammable substances.
Ether, benzene, alcohol, thinner, adhesive, spray, LP gas or any chemicals may explode and cause an accident.



Do not store

Do not store medicines, chemicals or chemical reagents.
This refrigerator is not suitable for storage of substances that are temperature sensitive.



Prohibited!

Do not place any heavy objects or liquid containers on the refrigerator.
Spillage may affect the electric insulation, and cause fire or electric shock.
Falling objects may also cause injury.



Do not eat
spoil food

Do not eat any food which has changed color or gives out strange odor.
These food may cause food poisoning or illnesses.



Disposal
method

When disposing the refrigerator
● Do not leave in places where children play.
● To protect a little children from dangerous confinement inside the refrigerator, remove the door packing so that the door can not be closed airtightly.
● Please contact with environmental protection unit to deal with discard insulation blowing gas.



Warning

The warning labels mentioned above should be kept throughout the life of the refrigerator.
The user manual should be handed over to any person who would use or handle the refrigerator whenever the refrigerator would be transferred to another location and delivered to a recycling plant.



注意



牢固插入
电源线插头

将插头牢固插入电源插座。
- 连接不当或松动会造成冰箱故障。
- 如果发现连接不当或松动，请采取必要措施，比如更换电源插座。

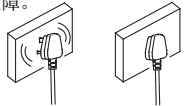

握住指定部位

移动冰箱时请从冰箱底部抬起。
如果不抓住此指定位置，您的手可能会打滑，导致受伤。

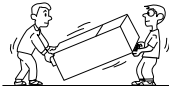

在平整表面
上安装

请在坚固平整的地面上安装。
若放置在不平或不稳的地面上，冰箱可能会倾覆导致人员受伤。



CAUTION



Plug in the
power cord
firmly

Connect the plug to power socket firmly.
- Poor or loose connection will cause malfunction of the refrigerator.
- Take necessary precautions such as replacement of power socket if poor or loose connection is observed.



Hold designated
positions

Lift from the bottom of the refrigerator when moving.
If you do not hold this designated position, your hands may slip and which may lead to injury.



Install on level
surface

Install on a strong and even floor.
The refrigerator may overturn if set on uneven or unstable surface, which may lead to injury.

注意



请小心。
如果拖动冰箱，可能会刮伤地板。

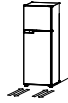

拉住把手关闭冰箱门。
否则关门时可能会夹伤手指。



确保冰箱门
完全关闭

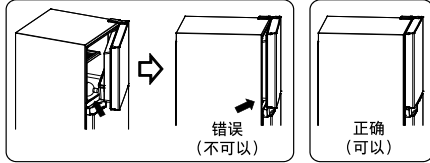

注意:

- 冷度不佳制冰缓慢
- 冷藏区结冻或结霜
- 冰箱滴水

- ✓ 请确认门妥善地关紧。
- ✓ 请确认冰箱内食物无妨碍门的关闭。



使冰箱门
完全关紧

将冰箱门关紧
务必确保冰箱门已正确关闭，使门框和门上的橡胶密封垫之间无任何空隙（内部的容器可能会造成空隙）。
- 将冰箱内的容器排齐，使其不会伸出搁架边缘。



请勿长时间
打开冰箱门

请勿使冰箱门长时间打开且/或请勿频繁打开和关闭冰箱门。
这将导致房间内的暖气流入冰箱并造成较差的制冷效果。



去除结露
和结霜

去除冰箱内部附着的水滴、霜（冰）或结露。
冰箱内部附着的水滴、霜（冰）或结露会在数日后自行消失。或者可用温水浸湿的布将其擦除后，再用干布擦拭。



切勿接触

切勿将手或脚贴在冰箱底部。
冰箱钢板等物会造成人员受伤。



切勿用
湿手接触

切勿用湿手接触冰箱的冷冻柜或制冰盘。
否则会冻伤您的手指。



切勿存放

请勿在冷冻柜里保存瓶子。
若瓶内物体被冻结，瓶子可能会破碎，导致人员受伤。



禁止!

切勿将水存放在冰盒中进行制冰，否则可能导致冰盒破裂。断开电源时，请将冰盒内残留的水排尽。



CAUTION



Move carefully

Please be careful.
If you drag a refrigerator, it may cause scratch to the floor.



Use the handle

Use the handle when closing the refrigerator door.
You may accidentally slam the door on your fingers.



Ensure doors
are closed
completely

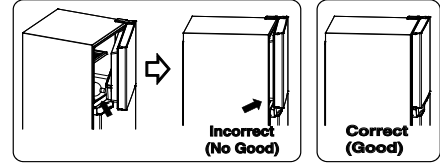

CAUTION :

- Poor Cooling Slow Ice Making
- Icing or frosting in Freezer Room
- Water Dropping in Refrigerator Room

- ✓ Ensure the doors are closed properly.
- ✓ Ensure that food inside do not block the door.



Secure the doors
completely

Secure the door closed
Make sure that the door has been closed properly without any gaps between the frame and rubber packing on the door which might be caused by containers inside.
- Align the container stored in the compartment not protruded from the edge of the shelf.



Do not open
the door for
a long period

Do not leave the door opened for a long period of time and/or do not frequently open and close the doors in short intervals.
This will result in warm air circulating in the room to enter the compartments and invoke poor cooling.



Dispose dew
and frost

Remove water droplets, frost (icing) or dew attached in the inner compartment.
A water drop, frost (icing) or dew attached to the inside of the refrigerator will disappear by itself in a few days. Or it can be taken away manually by wiping with a dry cloth after wiping off with a warm water moistened cloth.



Do not touch

Do not stick your hands or feet under the refrigerator.
Steel plates and the kinds may cause injury.



Do not touch
with wet hands

Do not touch the freezing unit nor ice tray with wet hands.
It may cause frostbites on your fingers.



Do not store

Do not store bottles in the freezing unit.
Bottles may break when the contents are frozen, and may cause injury.



Prohibited!

Do not store water in the ice box for ice making, this may cause it to break. Drain off remaining water in ice box when electric shutdown or plugging off.

安装

■ 安装

将冰箱安装在坚固水平的地面上。转动调整腿使冰箱保持水平。

- 左右侧的调整腿可上下调节。

- 顺时针转动调整腿可抬起冰箱两侧，逆时针转动则可降低。

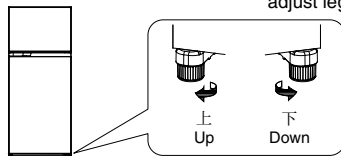

■ Installation

Install your refrigerator on a strong and level floor. Turn the adjust leg and stabilize the refrigerator horizontally.

- Adjust leg left and right side can be adjust up and down.

- Turn adjust leg clockwise to raise each side of the refrigerator, or turn counter clockwise lower it.

安装

■ 冰箱的安装位置。

不宜把冰箱置于潮湿的地方，例如厨房的水槽附近。否则会导致冰箱锈蚀或漏电。如直接放在地面上，则应在下面垫上木板等，否则也易损坏机器。

■ 远离阳光直射处及煤气炉或其它热源。

如果冰箱受阳光直射，或放置在其它热源附近，则会导致制冷效果下降，甚至产生故障。



■ 冰箱四周要留有空隙。

选择一个通风良好的地方。为了保证适当的空气流通，请在冰箱顶部和背面各留出至少10 cm (4英寸)、左右两侧各留出至少4 cm (1.6英寸) 的空间。

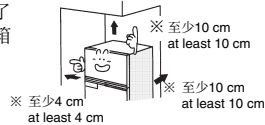

■ 初次打开冰箱门时，可能会有塑料的气味。这并非异常情况。

■ 不使用时关闭冰箱电源。

准备离开较长时间时，如果关闭冰箱电源，请取出所有食品并彻底清洁内部。从电源插座拔下电源线插头，并使冰箱门保持打开。

INSTALLATION

■ Installation position for refrigerator.

Avoid any humid or wet place, for example, the neighborhood of a kitchen sink. Such a place could cause corrosion or electric leakage in the refrigerator. If installed directly on the ground, your refrigerator will be liable to damage. Place a board under the machine in such a case.

■ Keep the refrigerator away from the sunlight, a gas range or heater.

Placed in the sunlight or near a heat emitting object, the refrigerator will have its cooling effect reduced and a failure might be occurred.

■ Leave space around the refrigerator.

Select a well-ventilated place. Provide at least 10 cm (4 inches) at top and rear side, and 4 cm (1.6 inches) on the left and right of the refrigerator for proper air circulation.

■ When you open the door of the refrigerator, there may be a smell of plastics. This signifies nothing unusual.

■ Switching off your refrigerator when not using.

If you switch your refrigerator off when you are going away for an extended period, remove all food, clean the interior thoroughly. Remove the power cord plug from the power socket and leave all doors open.

信息

● 压缩机发热

在正常工作情况下，冰箱的压缩机要向外放出热量。请注意这并非故障。

● 冰箱外壁上的热量

冰箱的冷凝器装于冰箱的外壁内，并通过冰箱外壁将热量散到室内。在正常工作时，冰箱外壁的温度会很高，这并非冰箱发生故障。

● 冰箱的运转

初次接通电源或环境温度升高时，可能会发生冰箱表面发热或压缩机发出噪音的情况。当冰箱进入稳定状态时，将正常运行。

INFORMATION

● Heat Generation by the Compressor

The refrigerator compressor will generate heat during normal operation. Note that this is not a malfunction.

● Heat on Refrigerator Walls

The condenser is built on the outer shell and radiates heat into the room air. The temperature of the outer shell may reach high temperature during normal refrigerator operation. This is not a malfunction.

● Refrigerator Operation

When the power is first turned on or ambient temperature becomes high, it may happen that the refrigerator surface getting warm or noise from the compressor. When the refrigerator enters stable state, it will run normally.

操作时的注意事项

移动和运输时

- 首先，取出食品。

- 在冰箱下方放一块布，使冰箱向后倾斜，排掉排水盘中的水。（如图所示）

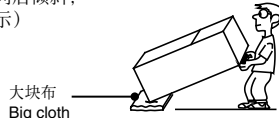

- 搬运时，请握住图示位置（切勿握住门或把手）。

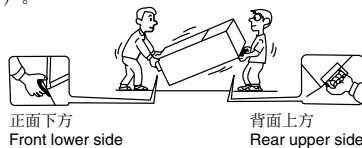

- 从墙壁电源插座上拔下电源插头后，请等待至少8分钟再重新连接。
- 如果在短时间内重新插入插头，则压缩机可能无法正常运行且会发生很响的噪音。

CAUTIONS FOR OPERATION

When moving and transporting

- Firstly, remove the food.

- Put a piece of cloth under the refrigerator, and lean the refrigerator backwards to remove water from drain pan. (as the picture)

- When carrying, hold the positions shown in the diagram. (Never hold by the door or the handle.)

After disconnecting the plug from the outlet, wait at least 8 minutes before reconnecting it.

- If the plug is quickly reconnected, the compressor may not run properly and produce a rattling noise.

冰箱细节和部件

REFRIGERATOR DETAILS AND PARTS

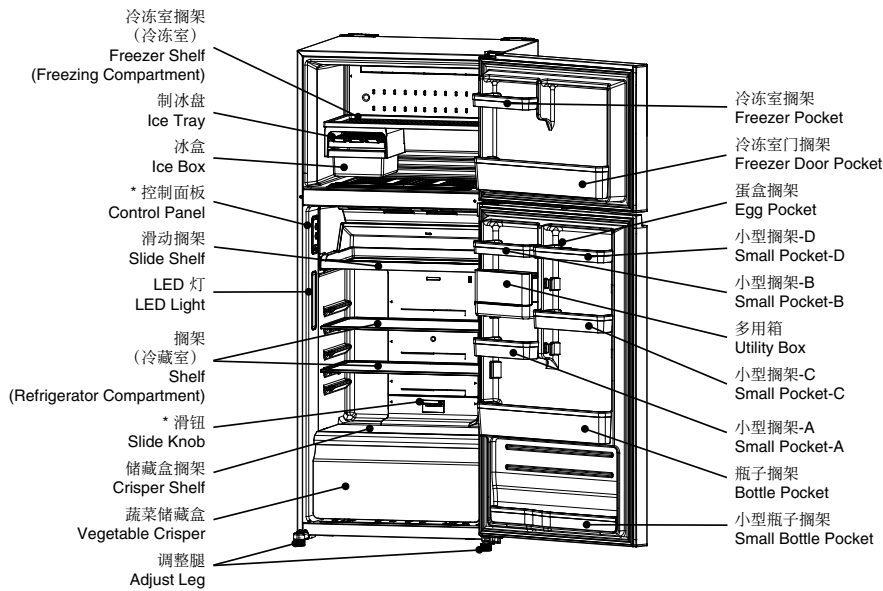

* 滑钮 Slide Knob

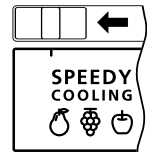

滑钮位于左侧时表示“快速制冷”

When slide knob position is on the left "Speedy cooling"



滑钮位于右侧时表示“保湿”

When slide knob position is on the right "Moisture keeping"

* 控制面板

Control panel

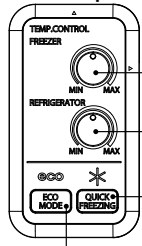

- 冷冻室温度控制拨盘
Temperature control freezer dial
- 冷藏室温度控制拨盘
Temperature control refrigerator dial
- 快速冷冻控制按钮
Quick freezing control button
- 节能模式控制按钮
Eco mode control button

* 注

关于温度设置位置的其它说明
MIN表示设定温度升高的位置
MAX表示设定温度降低的位置

* Note

Additional instructions on temperature setting positions
MIN indicates the position to set the temperature increased
MAX indicates the position to set the temperature decreased

适用于 GR-HG55MDZ, GR-HG52MDZ, GR-H55MBZ, GR-H52MBZ
For GR-HG55MDZ, GR-HG52MDZ, GR-H55MBZ, GR-H52MBZ

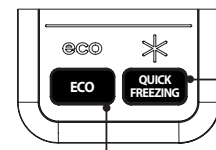

- Quick freezing control button
快速冷冻控制按钮
- Eco control button
节能控制按钮

功耗/型号 CONSUMPTION/MODEL	GR-HG52MDZ GR-H52MBZ GR-HG52SEDZ GR-H52SEBZ	GR-HG55MDZ GR-H55MBZ GR-HG55SEDZ GR-H55SEBZ
小型搁架-A Small Pocket-A	-	1个 / PC

如何正确有效地使用冰箱

HOW TO USE YOUR REFRIGERATOR CORRECTLY AND EFFECTIVELY

温度控制器

● 对于冷冻室和冷藏室

通常，将温度控制拨盘设定到中间位置。



● 冷藏室内的食物可能会结冰

当环境温度大幅下降（例如在冬天）时，将温度控制拨盘设定到“MIN”（最低）位置以防食物结冰。将含有高水分的食物（例如豆腐、蔬菜）放在冷藏室后部时，可能会结冰。



● 对于冷冻室，储藏冰淇淋时，温度应设定为低于中间位置

如果冰箱似乎不够冷，请将拨盘向“MAX”（最高）转动，如果似乎太冷，请将拨盘向“MIN”（最低）转动。

● 改变冷藏室的温度控制也会同时改变蔬菜储藏盒的温度。

● 请勿使食物或容器挡住冷流循环的出口和入口，否则食物将被冻住，或者整个冰箱将制冷不均。

Temperature Controls

● For both the Freezer and Refrigerator Compartments

Normally set the temperature control dial to the Middle position.

● Food may freeze in the refrigerator compartment

When the ambient temperature decreases excessively such as in the winter, set the temperature control dial to "MIN" position to prevent from food freezing. Food that has a high moisture content (e.g., tofu, vegetables) may freeze when it is placed at the back of the refrigerator compartment.

● For the freezer, when storing ice cream, the temperature should be set below Middle position

If the refrigerator does not seem cold enough, turn the dials toward "MAX", if it seems too cold, turn the dial toward "MIN".

● Changing the refrigerator compartment temperature control also varies the temperature in the vegetable crisper.

● Do not obstruct the outlet and inlet of the cool air circulation with food or containers, otherwise the food will be frozen or will not be cooled consistently throughout refrigerator.

如何正确有效地使用冰箱

- 请注意，滑动搁架时，较高的瓶子或物品可能会撞到顶部。
- 在冷冻室内存放物品时，将其放置在下图所示的通风口区域后方。
- 请勿在通风口上放置任何物品，因为可能会导致通风不良。
- 在通风口上放置物品将造成冰箱门无法正确关闭。

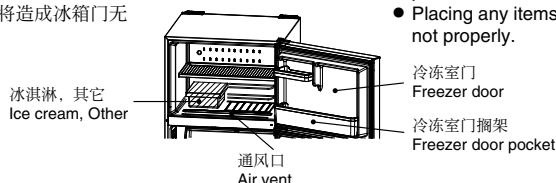

HOW TO USE YOUR REFRIGERATOR CORRECTLY AND EFFECTIVELY

- Please note, tall bottles or tall items may hit the ceiling when sliding the shelf.
- When storing any items in the freezer, place them behind the air vents area as show in the picture below.
- Do not place any items on the air vents, because it will cause poor air circulation.
- Placing any items on the air vents will cause the door closing not properly.

制冰方法

- 1** 制冰盘加水至水位线。
如果水高出水位线，结冰后冰块会不易被取出。
Fill the ice tray with water up to the water level line.
If the water exceeds the water level line, it will freeze over and becomes hard to remove.

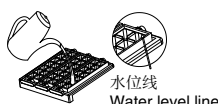

How to Make Ice

- 2** 若要取出冰块，请按图中所示扭转制冰盘。
To remove ice, twist the ice tray as shown in the figure.

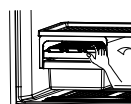

节能

想要将冰箱运行切换为节能模式时，使用此运行模式。

1. 按 **ECO MODE** 进入节能模式，**eco** 图标出现。
2. 若要停用此运行模式，再次按 **ECO MODE**，**eco** 图标消失。

注

- 进入节能模式时，冷冻室内的温度将升高至超过预设温度约 1~2°C。
- 节能性能取决于应用条件（温度控制、外部温度、开/关门的频率、食品量）。
- 如果觉得饮料不够冷或制冰用时太长，则应停用此功能。
- 对于以下机型，**ECO MODE** 会显示为 **ECO**：GR-HG55MDZ, GR-HG52MDZ, GR-H55MBZ, GR-H52MBZ

Energy Saving

Use this operation when you want to switch the operation refrigerator to an energy saving mode.

1. Press **ECO MODE** to enter energy saving mode, the **eco** icon appears.
2. To disable this operation, press **ECO MODE** again, the **eco** icon disappears.

Note

- While entering the energy saving mode, the temperature inside the freezer compartment will raise over the preset temperature for approximately 1~2°C.
- The performance of energy saving depends on the application conditions. (temperature control, outside temperature, the frequency of opening/closing the door, food amount)
- This function should be disable if you feel that the beverage is not cool enough or ice making takes too long time.
- **ECO MODE** will be displayed as **ECO** for GR-HG55MDZ, GR-HG52MDZ, GR-H55MBZ, GR-H52MBZ

快速冷冻

想要使饮料或其它食品快速制冷时，使用此运行模式。

1. 按 **QUICK FREEZING** 进入快速冷冻模式，* 图标出现。
2. 若要停用此运行模式，再次按 **QUICK FREEZING**，* 图标消失。

注

- 冰箱进入快速冷冻模式后将持续150分钟，然后恢复正常。
- 快速制冷性能取决于应用条件（外部温度、开/关门的频率、食品量）。
- 当冷冻室内的温度达到应用要求时，可以立即停用此模式。

Quick Freezing

Use this operation when you want the beverage or other cold quickly.

1. Press **QUICK FREEZING** to enter quick freezing mode, the * icon appears.
2. To disable the operation, press **QUICK FREEZING** again, the * icon disappears.

Note

- The refrigerator will enter the quick freezing mode for 150 minutes continually and then returns to the normal.
- The performance of quick refrigeration depends on the application conditions. (outside temperature, the frequency of opening/closing the door, food amount)
- You can deactivate this mode immediately after the temperature inside the freezer compartment reach the application requirement.

蔬菜储藏盒

可通过改变滑钮位置来控制气流。

1. 当滑钮位于右侧时：“保湿”，冷气在蔬菜储藏盒周围流动，蔬菜储藏盒间接变冷。储藏盒的水分保留，蔬菜新鲜度更持久。
2. 当滑钮位于左侧时：“快速制冷”，冷气直接进入储藏盒。此冷气使储藏盒快速制冷，蔬菜储藏盒的温度将比保湿模式低约1-2°C。

警告

- 当蔬菜储藏盒内因湿度过高而产生水滴时，将滑钮滑动至左侧。
- 由于蔬菜储藏盒很大，应看管儿童，确保其不在蔬菜储藏盒内玩耍或攀爬。

Vegetable crisper

You can control the air flow by changing the position of slide knob.

1. When slide knob position is right; "Moisture Keeping" Cold air goes around vegetable crisper and vegetable crisper gets cold indirectly. The moisture of crisper is kept and freshness of vegetable is kept longer.
2. When slide knob position is left; "Speedy Cooling" Cold air goes into the crisper directly. This direct air cool the crisper quickly and vegetable crisper temperature will decrease approximately 1-2°C moisture keeping mode.

Warning

- In case dew generating in vegetable crisper due to excessive humidity, slide lever to the left position.
- Due to the large size of vegetable crisper, children should be supervised to ensure they will not play or climb inside the vegetable crisper.

自动除霜

- 本冰箱可以自动除霜，免去了手动除霜的麻烦。
- 通过时间控制加热器自动除去蒸发器上的霜冻（外部可见）。

Self-defrosting

- This refrigerator is self-defrosting, eliminating the troublesome chore of manual defrosting.
- Any frost which forms on the evaporator (externally invisible) is automatically removed by the time-controlled heater.

LED 混合生物除臭装置

GR-HG55MDZ, GR-HG52MDZ,
GR-HG55SEDZ, GR-HG52SEDZ

- LED 混合生物除臭装置安装于滑动搁架后方。该新设备由以下部分组成：第一部分是用于有效杀菌和除臭的光催化剂，第二部分是用于杀菌和分解乙烯气体的光催化剂，第三部分是一个 LED 内置装置。这些光催化剂通过接收 LED 灯的光线，从冷气中的水分产生羟基。羟基可杀灭细菌、分解乙烯气体，从而使蔬菜保鲜，以及除臭。

LED HYBRID Deodorizer Unit

GR-HG55MDZ, GR-HG52MDZ,
GR-HG55SEDZ, GR-HG52SEDZ

- LED HYBRID Deodorizer Unit is installed behind sliding shelf. This new device consists as follows: The first one is a photocatalyst effective for bacteria elimination and deodorization, the second one is a photocatalyst for bacteria elimination and disintegration of ethylene gas, and the third one is a LED built-in unit. Receiving rays of LED lamp, these photocatalysts generate hydroxyl radicals from moisture in the cold air. Hydroxyl radicals inactivate bacteria, disintegrate ethylene gas which promotes vegetables aging, and deodorize odors.

信息

- 请将气味很浓的食品储藏在密闭容器内。

INFORMATION

- Store strong smell food in tightly sealed containers.

混合生物除臭装置

GR-H55MBZ, GR-H52MBZ,
GR-H55SEBZ, GR-H52SEBZ

- 此混合生物除臭装置安装在冷流循环处以杀菌、除臭并使蔬菜和水果保持新鲜。而且，此装置在使用寿命内无需保养。

HYBRID BIO Deodorizer Unit

GR-H55MBZ, GR-H52MBZ,
GR-H55SEBZ, GR-H52SEBZ

- This HYBRID BIO deodorizer unit is installed at the cool air circulation for bacteria elimination, deodorization and refreshing vegetables and fruits. In addition, you can use this unit without any maintenance throughout its duration.

信息

- 请将气味很浓的食品储藏在密闭的容器内。

INFORMATION

- Store strong smell food in tightly sealed containers.

LED 灯的更换

- 如果 LED 照明灯损坏，请联系 TOSHIBA 授权的维修商进行更换。LED 照明灯只能由专业维修人员进行拆卸。

LED Light Replacement

- When the LED light is blown, please contact the service agent approved by TOSHIBA for replacement. The LED light should only be removed by qualified service personnel.

故障检修

TROUBLESHOOTING

您认为冰箱有故障时，请确认以下几点。

If you think the refrigerator is not functioning properly, please check the following points.

冰箱完全不冷。 <ul style="list-style-type: none">● 冰箱插头是否正确插入插座？● 家用保险丝或断路器是否断开了？● 是否停电了？	The refrigerator does not get cold at all. <ul style="list-style-type: none">● Is the refrigerator plugged in properly?● Has the fuse for your house's electricity supply blown, or has the breaker shut off?● Has the electricity supply been shut off?
冰箱不够冷。 <ul style="list-style-type: none">● 温度控制拨盘是否设置于“MIN”（最低）处？● 是否处于太阳直晒，或者靠近热炉或加热器处？● 门是否正确地关上了？● 是否频繁地打开和关闭门？ 是否有热的东西放入了冰箱？● 冰箱内的东西是否放得过多了？● 冰箱周围的通风状况是否良好？	The refrigerator does not get cold enough. <ul style="list-style-type: none">● Is the temperature control dial set to “MIN”?● Is the refrigerator placed in direct sunlight, or near a stove or heater?● Is the door closed properly?● Is the door being opened and closed too frequently? Has anything hot been placed in the refrigerator?● Is the refrigerator overloaded?● Is there sufficient air circulation around the refrigerator?
冷藏室内的食物冻结。 <ul style="list-style-type: none">● 温度控制拨盘是否设置于“MAX”（最高）处？● 周围温度是否低于5°C？● 冷藏室的后部是否放入了高湿度的食品？这样容易导致冻结。	Food in the refrigerator compartment freezes. <ul style="list-style-type: none">● Is the temperature control dial set to “MAX”?● Is the surrounding temperature below 5°C?● Have you placed food with a high moisture content at the rear of the compartment, hence making it prone to freezing?
噪音高。 <ul style="list-style-type: none">● 地板是否坚固且水平？● 冰箱周围是否留有托盘或盆碟？● 冰箱是否不稳定，或者碰到了周围的墙壁？	The refrigerator makes a loud noise. <ul style="list-style-type: none">● Is the floor firm and level?● Have any trays or dishes been left around the refrigerator?● Is the refrigerator unstable, or touching the wall?
冰箱外结露。 <ul style="list-style-type: none">● 有时冰箱外面会结露，特别是在如梅雨季节这样的高湿度的情况下。这如同冷水注入杯内时杯子周围会形成水滴一样的原理，这并非故障。冰箱外有结露时，请用干布将其擦拭干净。	Moisture forms on the outside of the refrigerator. <ul style="list-style-type: none">● Sometimes moisture may form on the outside of the refrigerator, particularly when humidity is high, such as during the rainy season. This is just the same as moisture forming on a glass which contains cold water, and is not indicative of a malfunction. If moisture forms inside the refrigerator, just wipe it off with a dry cloth.
冰箱内结露。 <ul style="list-style-type: none">● 是否频繁地打开和关闭门，或者是长时间地开着冰箱门？● 是否有高湿度的食品没有密封而被放入了冰箱？冰箱内有结露时，请用干布将其擦拭干净。	Moisture forms on the inside of the refrigerator. <ul style="list-style-type: none">● Is the door being opened and closed too frequently, or left open for long periods of time?● Has food with a high moisture content been left uncovered in the refrigerator? If moisture forms inside the refrigerator, wipe it off with a dry cloth.
注意：冷藏室上结露 <ul style="list-style-type: none">- 请用干布擦去露水以防积聚。- 为了防止冷藏室内露水过多，请务必注意。 请勿频繁地打开冰箱门。 请勿使冰箱门长时间开着。 务必关紧冰箱门。	CAUTION : Dewing on refrigerator compartment <ul style="list-style-type: none">- Please wipe off the dews by using dry clothes to prevent the accumulation.- To prevent the excessive dews in the compartment, please pay attention. Do not to open the door often in a short interval. Do not to leave the door opened for a long period. Please ensure the door is closed properly.
 <p>(*) 由于冷藏室内的冷气管较冷，管道表面会因打开冰箱门时外部空气进入，或冷藏室内留有食品蒸发的水分而结露。</p> <p>(*) 保持关闭冰箱门时，露水将自然消失。去除露水时，请用干布擦拭。</p>	<p>(*) Due to colder cooling air duct in compartment, dewing may be generated on duct surface by invasion of outside air when opening the door or water evaporation from food kept in the compartment.</p> <p>(*) This dews will disappear naturally while keeping the door closed continuously. Please wipe off it by dry clothes while you care to take the dews out.</p>

节能指导

1. 保持电器周边或内置结构的通风口无阻碍。
2. 为了使本冰箱尽可能节能，搁架、储藏盒、门搁架等内部部件应根据本说明书所述的位置放置。
3. 在冰箱周围留出空间。
 - 在顶部和背面各留出至少10 cm（4英寸）、左右两侧各留出至少4 cm（1.6英寸）的空间。
4. 在阴凉的地方使用。
5. 使冰箱远离日光、煤气灶或加热器。
6. 请勿使食物或容器挡住冷风入口和出口，否则冰箱内的食物可能无法持续保持制冷。
7. 请勿放入过多食物。应留出足够空间使内部冷风循环。
8. 请勿将冰箱温度设置低于所需温度。
9. 存放热食前应先使其冷却。
10. 冰箱门打开的时间应尽量短。

GUIDANCE FOR ENERGY SAVING

1. Keep ventilation openings, in the appliance enclosure or in the built-in structure, clear of obstruction.
2. To get the most efficient use of energy for this refrigerator, the interior part such as shelves, crisper, pockets should be set following to its position mention in this instruction booklet.
3. Leave space around the refrigerator.
 - Provide at least 10 cm (4 inches) at top and rear side and 4 cm (1.6 inches) on both left and right.
4. Use in a cool place.
5. Keep the refrigerator away from the sunlight, a gas range or heater.
6. Do not obstruct the outlet and inlet of the cool air circulation with food or containers, otherwise the food will not be cooled consistently throughout refrigerator.
7. Do not put in too much food. Should provide enough space for internal cool air circulating.
8. Do not set the temperature of refrigerator lower than needed.
9. Hot food should be cooled before storing.
10. Open your refrigerator door as briefly as possible.

附件的拆卸方法

附件可按下述方法容易地卸下以便清洗。至于安装方法，请按拆卸方法相反的顺序进行。为了拆卸附件，请将冰箱门完全打开。
预防措施：拆卸及组装时，请注意掉落的物件会造成危险。

HOW TO REMOVE ACCESSORY PARTS

The accessory parts can be easily removed as explained below for easier cleaning. Only the removal steps are explained here. Replace each part in reverse order. For part removal, open the door fully.
Precaution: Please beware of dangers from falling objects while removing and assembling.

搁架

抬起并向您身体的方向拉。
Lift up and pull towards you.

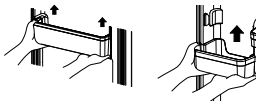

Pockets

多用箱

抬起并向您身体的方向拉。
Lift up and pull towards you.

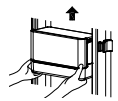

Utility Box

冷冻室搁架

稍稍抬起搁架，然后拉出。
Lightly lift up the shelf then pull it out.



Freezer Shelf

滑动搁架

拉出搁架直至其停止，然后抬起并向您身体的方向拉。请小心，搁架可能会因其重量而从手中滑落。
Pull out the shelf until it stops then lift it up and pull towards you. Be careful, the shelf may slip out of your hands due to its weight.

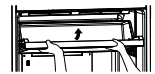

Sliding Shelf

搁架和储藏盒搁架

稍稍抬起搁架的同时将其拉出直至停止。然后将其拉出。对于储藏盒搁架，请先取出蔬菜储藏盒。
请小心，搁架可能会因其重量而从手中滑落。

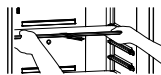

Shelf and Crisper Shelf

蔬菜储藏盒

稍稍抬起蔬菜储藏盒的同时将其拉出直至停止，然后将其向外拉。
Pull out the vegetable crisper until it stops lift slightly, and then pull it outward.

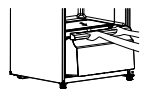

Vegetable Crisper

定期保养

为了确保您的东芝冰箱的最大使用寿命，请定期清洁其部件。（有关正确操作，请仔细阅读以下文章。
清洁时，请确保将冰箱的插头从插座中拔出，并当心不要拉扯电线或使其缠在冰箱下面。请勿将水直接倒到冰箱上。

PERIODIC MAINTENANCE

To ensure the maximum life of your Toshiba Refrigerator, periodically clean its parts. (For proper instructions, read the following directions carefully.)

When cleaning them, be sure to pull out the refrigerator's plug from the power socket and be careful not to pull the cord or get it caught under the machine. Do not pour water directly on the refrigerator.

外表面

用软布擦亮。应用浸有天然洗涤剂的软布擦拭严重的脏污。
用干布擦拭门把手。

Outside Surfaces

Polish them with a soft rag. A heavy stain should be wiped off with a rag soaked in a natural detergent.
The door handle should be wiped with a dry cloth.

门密封条

如不除去密封条上的脏污，则其寿命将缩短。
不定期地检查门密封条并用清洁剂将脏污擦去。

Door Packing

The packing on the doors will be short-lived if stains are not removed. Occasionally, inspect the packing on the doors, and remove any stain with a natural detergent.

内部塑料部件

有脏污或有异味时，请用天然洗涤剂清洁内部塑料部件。
有沙拉油或其它食用油的油迹时，内部塑料部件会破裂。请将油迹擦除。

Interior Plastic Units

If they are stained or have any odor, the interior plastic units should be cleaned with a natural detergent.
When smeared with salad oil or other cooking oil, the interior plastic unit may crack. Wipe such smears off.

TOSHIBA
Leading Innovation >>>

XMGZ-A