

# TOSHIBA



Microwave Oven

## INSTRUCTION MANUAL

Model:

# MW2-AC26TF(BK)

**Read these instructions carefully before using your microwave oven, and keep it carefully.**

If you follow the instructions, your oven will provide you with many years of good service.

**SAVE THESE INSTRUCTIONS CAREFULLY**



# Welcome to the world of **TOSHIBA**

BEFORE OPERATING THIS PRODUCT,  
READ, UNDERSTAND, AND FOLLOW THESE INSTRUCTIONS.  
BE SURE TO SAVE THIS BOOKLIST FOR FUTURE REFERENCE

## **CONTENTS**

**PRECAUTIONS TO AVOID POSSIBLE EXPOSURE TO EXCESSIVE  
MICROWAVE ENERGY**

**IMPORTANT SAFETY INSTRUCTIONS**

**GROUNDING INSTRUCTIONS**

---

**UTENSILS**

**SETTING UP YOUR OVEN**

---

**OPERATION**

**TROUBLE SHOOTING**

# PRECAUTIONS TO AVOID POSSIBLE EXPOSURE TO EXCESSIVE MICROWAVE ENERGY

---



(a) Do not attempt to operate this oven with the door open since this can result in harmful exposure to microwave energy. It is important not to break or tamper with the safety interlocks.

(b) Do not place any object between the oven front face and the door or allow soil or cleaner residue to accumulate on sealing surfaces.

(c) **WARNING:** If the door or door seals are damaged, the oven must not be operated until it has been repaired by a competent person.

## ADDENDUM

If the apparatus is not maintained in a good state of cleanliness, its surface could be degraded and affect the lifespan of the apparatus and lead to a dangerous situation.

### Specifications

Model:	MW2-AC26TF(BK)
Rated Voltage:	230-240V~50Hz
Rated Input Power(Microwave):	1450-1500W
Rated Output Power(Microwave):	900-950W
Rated Input Power(Grill):	1100-1150W
Rated Input Power(Convection):	2100-2250W
Oven Capacity:	26 L
Turntable Diameter:	∅315mm
External Dimensions:	513×513×310mm
Net Weight:	Approx. 18.2 kg

# IMPORTANT SAFETY INSTRUCTIONS WARNING

---



To reduce the risk of fire, electric shock, injury to persons or exposure to excessive microwave oven energy when using your appliance, follow basic precautions, including the following:

1. Read and follow the specific: "PRECAUTIONS TO AVOID POSSIBLE EXPOSURE TO EXCESSIVE MICROWAVE ENERGY".
2. This appliance can be used by children aged from 8 years and above and persons with reduced physical, sensory or mental capabilities or lack of experience and knowledge if they have been given supervision or instruction concerning use of the appliance in a safe way and understand the hazards involved. Children shall not play with the appliance. Cleaning and user maintenance shall not be made by children unless they are older than 8 and supervised. Children less than 8 years of age shall be kept away unless continuously supervised.
3. Keep the appliance and its cord out of reach of children less than 8 years.
4. If the supply cord is damaged, it must be replaced by the manufacturer, its service agent or similarly qualified persons in order to avoid a hazard. (For appliance with type Y attachment)
5. **WARNING:** Ensure that the appliance is switched off before replacing the lamp to avoid the possibility of electric shock.

# IMPORTANT SAFETY INSTRUCTIONS WARNING

---



6. WARNING: It is hazardous for anyone other than a competent person to carry out any service or repair operation that involves the removal of a cover which gives protection against exposure to microwave energy.
7. WARNING: Liquids and other foods must not be heated in sealed containers since they are liable to explode.
8. When heating food in plastic or paper containers, keep an eye on the oven due to the possibility of ignition.
9. Only use utensils that are suitable for use in microwave ovens.
10. If smoke is emitted, switch off or unplug the appliance and keep the door closed in order to stifle any flames.
11. Microwave heating of beverages can result in delayed eruptive boiling, therefore care must be taken when handling the container.
12. The contents of feeding bottles and baby food jars shall be stirred or shaken and the temperature checked before consumption, in order to avoid burns.
13. Eggs in their shell and whole hard-boiled eggs should not be heated in microwave ovens since they may explode, even after microwave heating has ended.
14. The oven should be cleaned regularly and any food deposits removed.
15. Failure to maintain the oven in a clean condition could lead to deterioration of the surface that could adversely affect the life of the appliance and possibly result in a hazardous situation.

# IMPORTANT SAFETY INSTRUCTIONS WARNING

---



16. The appliance must not be installed behind a decorative door in order to avoid overheating. (This is not applicable for appliances with decorative door.)
17. Only use the temperature probe recommended for this oven. (for ovens provided with a facility to use a temperature-sensing probe.)
18. The microwave oven shall not be placed in a cabinet unless it has been tested in a cabinet.
19. The microwave oven must be operated with the decorative door open. (for ovens with a decorative door.)
20. This appliance is intended to be used in household and similar applications such as:
  - staff kitchen areas in shops, offices and other working environments;
  - by clients in hotels, motels and other residential type environments;
  - farm houses;
  - bed and breakfast type environments.
21. The microwave oven is intended for heating food and beverages. Drying of food or clothing and heating of warming pads, slippers, sponges, damp cloth and similar may lead to risk of injury, ignition or fire.
22. Metallic containers for food and beverages are not allowed during microwave cooking.
23. The appliance shall not be cleaned with a steam cleaner.

# IMPORTANT SAFETY INSTRUCTIONS WARNING

---



- 24. The appliance is intended to be used freestanding.
- 25. The rear surface of appliances shall be placed against a wall.
- 26. Steam cleaner is not to be used.
- 27. Surface of a storage drawer can get hot.
- 28. Do not use harsh abrasive cleaners or sharp metal scrapers to clean the oven door glass since they can scratch the surface, which may result in shattering of the glass.
- 29. WARNING: The appliance and its accessible parts become hot during use. Care should be taken to avoid touching heating elements. Children less than 8 years of age shall be kept away unless continuously supervised.
- 30. During use the appliance becomes hot. Care should be taken to avoid touching heating elements inside the oven.
- 31. WARNING: Accessible parts may become hot during use. Young children should be kept away.
- 32. WARNING: When the appliance is operated in the combination mode, children should only use the oven under adult supervision due to the temperatures generated.

**READ CAREFULLY AND KEEP FOR FUTURE REFERENCE**



# TO REDUCE THE RISK OF INJURY TO PERSONS GROUNDING INSTALLATION

---



## **DANGER**

Electric Shock Hazard

Touching some of the internal components can cause serious personal injury or death. Do not disassemble this appliance.

## **WARNING**

Electric Shock Hazard

Improper use of the grounding can result in electric shock. Do not plug into an outlet until appliance is properly installed and grounded.

This appliance must be grounded. In the event of an electrical short circuit, grounding reduces the risk of electric shock by providing an escape wire for the electric current. This appliance is equipped with a cord having a grounding wire with a grounding plug. The plug must be plugged into an outlet that is properly installed and grounded.

Consult a qualified electrician or serviceman if the grounding instructions are not completely understood or if doubt exists as to whether the appliance is properly grounded. If it is necessary to use an extension cord, use only a 3-wire extension cord.

# TO REDUCE THE RISK OF INJURY TO PERSONS GROUNDING INSTALLATION

---



1. A short power-supply cord is provided to reduce the risks resulting from becoming entangled in or tripping over a longer cord.
2. If a long cord set or extension cord is used:
  - 1)The marked electrical rating of the cord set or extension cord should be at least as great as the electrical rating of the appliance.
  - 2)The extension cord must be a grounding-type 3-wire cord.
  - 3)The long cord should be arranged so that it will not drape over the counter top or tabletop where it can be pulled on by children or tripped over unintentionally.

## CLEANING

Be sure to unplug the appliance from the power supply.

1. Clean the cavity of the oven after using with a slightly damp cloth.
2. Clean the accessories in the usual way in soapy water.
3. The door frame and seal and neighbouring parts must be cleaned carefully with a damp cloth when they are dirty.
4. Do not use harsh abrasive cleaners or sharp metal scrapers to clean the oven door glass since they can scratch the surface, which may result in shattering of the glass.
5. Cleaning Tip---For easier cleaning of the cavity walls that the food cooked can touch: Place half a lemon in a bowl, add 300ml (1/2 pint) water and heat on 100% microwave power for 10 minutes. Wipe the oven clean using a soft, dry cloth.

# TO REDUCE THE RISK OF INJURY TO PERSONS GROUNDING INSTALLATION

---



## UTENSILS CAUTION

### Personal Injury Hazard

It is hazardous for anyone other than a competent person to carry out any service or repair operation that involves the removal of a cover which gives protection against exposure to microwave energy.

See the instructions on "Materials you can use in microwave oven or to be avoided in microwave oven."

There may be certain non-metallic utensils that are not safe to use for microwaving. If in doubt, you can test the utensil in question following the procedure below.

Utensil Test:

1. Fill a microwave-safe container with 1 cup of cold water (250ml) along with the utensil in question.
2. Cook on maximum power for 1 minute.
3. Carefully feel the utensil. If the empty utensil is warm, do not use it for microwave cooking.
4. Do not exceed 1 minute cooking time.

# MATERIALS YOU CAN USE IN MICROWAVE OVEN

UTENSILS	REMARKS
Browning dish	Follow manufacturer's instructions. The bottom of browning dish must be at least 3/16 inch (5mm) above the turntable. Incorrect usage may cause the turntable to break.
Dinnerware	Microwave-safe only. Follow manufacturer's instructions. Do not use cracked or chipped dishes.
Glass jars	Always remove lid. Use only to heat food until just warm. Most glass jars are not heat resistant and may break.
Glassware	Heat-resistant oven glassware only. Make sure there is no metallic trim. Do not use cracked or chipped dishes.
Oven cooking bags	Follow manufacturer's instructions. Do not close with metal tie. Make slits to allow steam to escape.
Paper plates and cups	Use for short-term cooking/warming only. Do not leave oven unattended while cooking.
Paper towels	Use to cover food for reheating and absorbing fat. Use with supervision for a short-term cooking only.
Parchment paper	Use as a cover to prevent splattering or a wrap for steaming.
Plastic	Microwave-safe only. Follow the manufacturer's instructions. Should be labeled "Microwave Safe". Some plastic containers soften, as the food inside gets hot. "Boiling bags" and tightly closed plastic bags should be slit, pierced or vented as directed by package.
Plastic wrap	Microwave-safe only. Use to cover food during cooking to retain moisture. Do not allow plastic wrap to touch food.
Thermometers	Microwave-safe only (meat and candy thermometers).
Wax paper	Use as a cover to prevent splattering and retain moisture.

# MATERIALS TO BE AVOIDED IN MICROWAVE OVEN

UTENSILS	REMARKS
Aluminum tray	May cause arcing. Transfer food into microwave-safe dish.
Food carton with metal handle	May cause arcing. Transfer food into microwave-safe dish.
Metal or metal-trimmed utensils	Metal shields the food from microwave energy. Metal trim may cause arcing.
Metal twist ties	May cause arcing and could cause a fire in the oven.
Paper bags	May cause a fire in the oven.
Plastic foam	Plastic foam may melt or contaminate the liquid inside when exposed to high temperature.
Wood	Wood will dry out when used in the microwave oven and may split or crack.

# SETTING UP YOUR OVEN

## NAMES OF OVEN PARTS AND ACCESSORIES

Remove the oven and all materials from the carton and oven cavity. Your oven comes with the following accessories:

- Glass tray 1
- Turntable ring assembly 1
- Instruction Manual 1

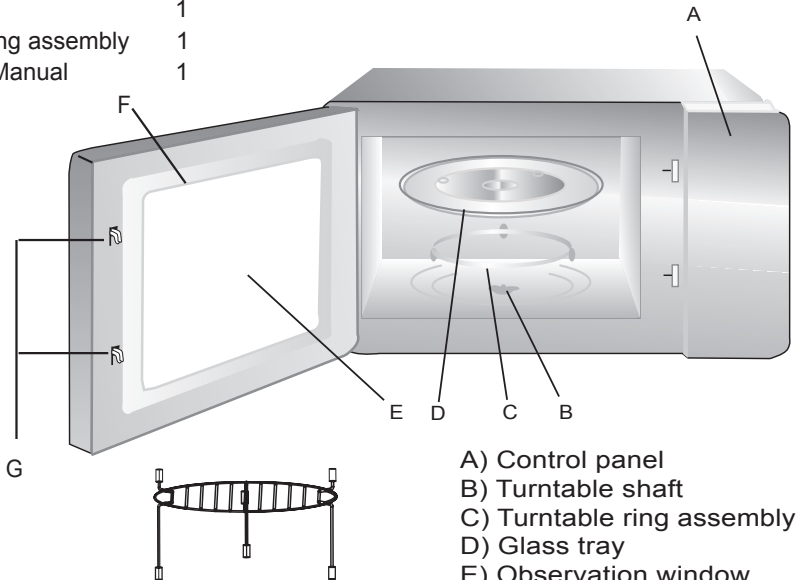

- A) Control panel
- B) Turntable shaft
- C) Turntable ring assembly
- D) Glass tray
- E) Observation window
- F) Door assembly
- G) Safety interlock system

Grill Rack( Can not be used in microwave function and must be placed on the glass tray )

### Turntable Installation

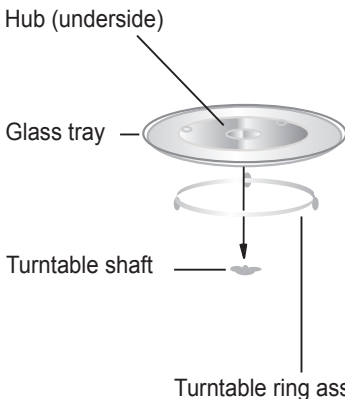

- Never place the glass tray upside down. The glass tray should never be restricted.
- Both glass tray and turntable ring assembly must always be used during cooking.
- All food and containers of food are always placed on the glass tray for cooking.
- If glass tray or turntable ring assembly cracks or breaks, contact your nearest authorized service center.

# SETTING UP YOUR OVEN

## COUNTERTOP INSTALLATION

Remove all packing material and accessories. Examine the oven for any damage such as dents or broken door. DO not install if oven is damaged.

Cabinet: Remove any protective film found on the microwave oven cabinet surface. Do not remove the light brown Mica cover that is attached to the oven cavity to protect the magnetron.

### Installation

1. Select a level surface that provide enough open space for the intake and/or outlet vents.

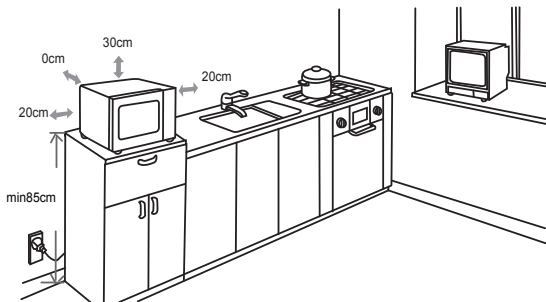

- (1) The minimum installation height is 85cm.
- (2) The rear surface of appliance shall be placed against a wall. Leave a minimum clearance of 30cm above the oven, a minimum clearance of 20cm is required between the oven and any adjacent walls.
- (3) Do not remove the legs from the bottom of the oven.
- (4) Blocking the intake and/ or outlet openings can damage the oven.
- (5) Place the oven as far away from radios and TV as possible. Operation of microwave oven may cause interference to your radio or TV reception.

# SETTING UP YOUR OVEN

---

## INSTALLATION

2.Plug your oven into a standard household outlet. Be sure the voltage and the frequency is the same as the voltage and the frequency on the rating label.

## WARNING

Do not install oven over a range cooktop or other heat-producing appliance. If installed near or over a heat source, the oven could be damaged and the warranty would be void.



The accessible surface may  
be hot during operation



# OPERATION INSTRUCTIONS

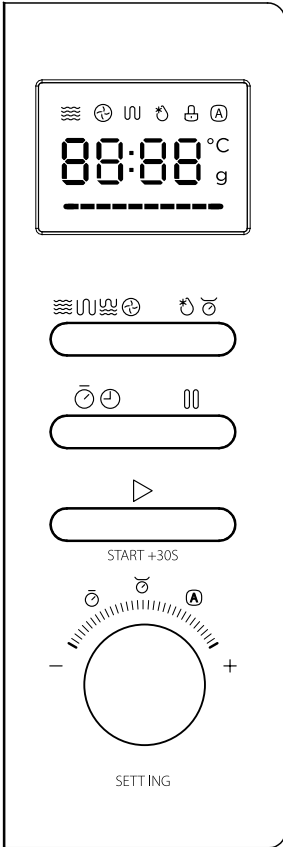

: Micro./Grill/Combi./Conv

: Weight/Time Defrost

: Clock/Kitchen Timer

: Stop/Clear

: Start/+30Sec./Confirm

: Turn the knob to select the function you need and cooking time, weight.

# OPERATION INSTRUCTIONS

This microwave oven uses modern electronic control to adjust cooking parameters to meet your needs better for cooking.

## 1. Clock Setting

1) In waiting state, press "**Clock/Kitchen Timer**" once, "00:00" displays.

Hour figures flash.

2) Turn "  " to adjust the hour figures, the input time should be within 0--23.

3) Press "**Clock/Kitchen Timer**", the minute figures will flash.

4) Turn "  " to adjust the minute figures, the input time should be within 0--59.

5) Press "**Clock/Kitchen Timer**" to finish clock setting. ":" will flash.

Note: 1) The clock will not work if is not set when powered.

2) During the process of clock setting, if you press "**Stop/Clear**", it will exit the setting state.

## 2. Microwave Cooking

1) Press the "**Micro./Grill/Combi./Conv.**" key once and , "P100" displays .

2) Press "**Micro./Grill/Combi./Conv.**" for times or turn "  " to select the microwave power from 100% to 10%. "P100", "P80", "P50", "P30", "P10" will display in order.

3) Press "**Start/+30Sec./Confirm**" to confirm.

4) Turn "  " to adjust the cooking time. (The time setting should be 0:05- 95:00.)

5) Press "**Start/+30Sec./Confirm**" to start cooking.

NOTE: the step quantities for the adjustment time of the coding switch are as follow:



0---1 min : 5 seconds  
1---5 min : 10 seconds  
5---10 min : 30 seconds  
10---30 min : 1 minute  
30---95 min : 5 minutes

Microwave Power Chart

Press	Once	Twice	Thrice	4 times	5 times
Display	P100	P80	P50	P30	P10



# OPERATION INSTRUCTIONS

## 3. Grill Cooking

- 1) Press the " **Micro./Grill/Combi./Conv.**" key once, and "P100" displays.
- 2) Press " **Micro./Grill/Combi./Conv.** " for times or turn "  " to select the grill function. When "G-1" displays, it indicates grill function.
- 3) Press " **Start/+30Sec./Confirm** " to confirm.
- 4) Turn "  " to adjust the cooking time. (The time setting should be 0:05- 95:00.)
- 5) Press " **Start/+30Sec./Confirm** " to start cooking.

Note: If half the grill time passes, the oven will sound twice to tell you to turn over the food. You can just leave it continue. But in order to have a better effect of grilling food, you should turn the food over, close the door, and then press" **Start/+30Sec./Confirm** " to continue cooking.

## 4. Combination Cooking

- 1) Press the " **Micro./Grill/Combi./Conv.** " key once, and "P100" displays.
- 2) Press " **Micro./Grill/Combi./Conv.** " for times or turn "  " to select the combination function. Stop turning when "C-1","C-2","C-3","C-4" displays.
- 3) Press " **Start/+30Sec./Confirm** " to confirm.
- 4) Turn "  " to adjust the cooking time. (The time setting should be 0:05- 95:00.)
- 5) Press " **Start/+30Sec./Confirm** " to start cooking.



Note: Combination instructions

Instructions	Display	Microwave	Grill	Convection
1	C-1	●		●
2	C-2	●	●	
3	C-3		●	●
4	C-4	●	●	●

# OPERATION INSTRUCTIONS

## 5. Convection Cooking(With preheating funtion)

The convection cooking can let you to cook the food as a traditional oven. Microwave is not used. It is recommended that you should preheat the oven to the appropriate temperature before placing the food in the oven.



- 1) Press the " **Micro./Grill/Combi./Conv.**" key once, and "P100" displays.
- 2) Press " **Micro./Grill/Combi./Conv.**" for times or turn "  " to select the convection temperature. When convection temperature displays, it indicates convection function. The temperature can be chosen from 150 degrees to 220 degrees.
- 3) Press the " **Start/+30Sec./Confirm** " to confirm the temperature
- 4) Press the " **Start/+30Sec./Confirm** " to start preheating. When the preheating temperature arrives, the buzzer will sound twice to remind you to put the food into the oven. And the preheated temperature is displayed and flash.
- 5) Put the food into the oven and close the door.  
Turn "  " to adjust the cooking time. (The maximum setting time is 95 minutes.)
- 6) Press the " **Start/+30Sec./Confirm** " key to start cooking.

Note: a. Cooking time cannot be input until the preheating temperature arrives.

If the temperature arrives, door must be opened to input the cooking time.

- b. If the time not input in 5 minutes, the oven will stop preheating. The buzzer sound five times and turn back to waiting states.

## 6. Convection Cooking( Without pre-heating function)

- 1) Press the " **Micro./Grill/Combi./Conv.**" key once, and "P100" displays.
- 2) Press " **Micro./Grill/Combi./Conv.**" for times or turn "  " to select the convection temperature. When convection temperature displays, it indicates convection function. The temperature can be chosen from 150 degrees to 220 degrees.
- 3) Press the " **Start/+30Sec./Confirm** " to confirm the temperature
- 4) Turn "  " to adjust the cooking time. (The maximum setting time is 95 minutes.)
- 5) Press the " **Start/+30Sec./Confirm** " key to start cooking.

# OPERATION INSTRUCTIONS



---

## 7. Multi-Stage Cooking

Two stages can be maximumly set. If one stage is defrosting, it will be put in the first stage automatically. The buzzer will ring once after each stage and the next stage will begin.

Note: Auto menu and preheating cannot be set as one of the multi-stage.

Example: if you want to defrost the food for 5 minutes, then to cook with 80% microwave power for 7 minutes. The steps are as following:

- 1) Press " **Weight/Time Defrost** " twice, the screen will display "d-2";
- 2) Turn "  " to adjust the defrost time of 5 minutes;
- 3) Press " **Micro./Grill/Combi./Conv.** " once;
- 4) Turn "  " to choose 80% microwave power till "P80" display;
- 5) Press " **Start/+30Sec./Confirm** " to confirm;
- 6) Turn "  " to adjust the cooking time of 7 minutes;
- 7) Press " **Start/+30Sec./Confirm** " to start cooking.

## 8. KITCHEN TIMER

- 1) In waiting state, press " **Clock/Kitchen Timer** " twice, "00:00" displays.
- 2) Turn "  " to adjust the timer. The MAX.time is 95 minutes.
- 3) Press " **Clock/Kitchen Timer** " to confirm.

Note: 1) The kitchen time is different from 24-hour system. Kitchen Timer is a timer.

2) During kitchen timer, any program cannot be set.

## 9. Speedy Cooking

1) In waiting state, press " **Start/+30Sec./Confirm** " key to cook with 100% power level for 30 seconds. Each press on the same key can increase 30 seconds. The maximum cooking time is 94 minutes and 59 seconds.

Note: this function cannot work under defrost by weight or auto menu cooking.

2) During microwave, grill, convection and combination states, press " **Start/+30Sec./Confirm** " key can increase 30 seconds of cooking time.



Note: this function cannot work under defrost by weight or auto menu cooking.

3) In waiting state, turn "  " left to choose cooking time directly then press " **Start/+30Sec./Confirm** " key to cook with 100% microwave power.

This program can be set as the first one of multi-stage.

# OPERATION INSTRUCTIONS

## 10. Auto Menu

- 1) In waiting state, turn "  " right to choose the function wanted, and "A1","A2","A3"...."A10" will be displayed.
- 2) Press " **Start/+30Sec./Confirm** " to confirm the menu you need.
- 3) Turn "  " to choose the weight of menu, and "g" indicator will light.
- 4) Press " **Start/+30Sec./Confirm** " to start cooking.

Note: Cake menu is under convection cooking with 180°C-warm-up function, and you should preheat first following the auto menu operation, when the oven reaches the temperature, it will stop working and sound to remind opening the door to put cake in, then press " **Start/+30Sec./Confirm** " to start cooking.

# OPERATION INSTRUCTIONS

Auto menu Chart

Menu	Weight	Display	Power
A1 Reheat	150g	150	100%
	250g	250	
	350g	350	
	450g	450	
	600g	600	
A2 Potato	1 (about 230g)	1	100%
	2 (about 460g)	2	
	3 (about 690g)	3	
A3 Meat	150g	150	100%
	300g	300	
	450g	450	
	600g	600	
A4 Vegetable	150g	150	100%
	350g	350	
	500g	500	
A5 Fish	150g	150	80%
	250g	250	
	350g	350	
	450g	450	
	650g	650	
A6 Pasta	50g(with water 450ml)	50	80%
	100g(with water 800ml)	100	
	150g(with water 1200ml)	150	
A7 Soup	200ml	200	100%
	400ml	400	
	600ml	600	
A8 Cake	475g	475	Preheat at 160 degrees
A9 Pizza	200g	200	C-2
	300g	300	
	400g	400	
A10 Chicken	500g	500	C-4
	750g	750	
	1000g	1000	
	1200g	1200	

# OPERATION INSTRUCTIONS

---

## 11. Defrost by W.T.

- 1) Press " **Weight/Time Defrost** " pad once, the oven will display "d-1".
- 2) Turn "  " to select the weight of food. At the same time, "g" will light, The weight should be 100-2000g.
- 3) Press " **Start/+30Sec./Confirm** " key to start defrosting.

## 12. Defrost by Time

- 1) Press " **Weight/Time Defrost** " key twice, the oven will display "d-2" .
- 2) Turn "  " to select the cooking time. The maximum setting time is 95 minutes.
- 3) Press " **Start/+30Sec./Confirm** " key to start defrosting.

The defrosting power is P30 and it cannot be changed.

Note: If the food weight is no more than 200 grams, please place the food at the edge of the glass turntable but not the center to be defrosted.

## 13. Inquiring Function

- 1) In cooking state, press " **Micro./Grill/Combi./Conv.**", the current power will be displayed for 2-3 seconds.
- 2) During cooking state, press " **Clock/Kitchen Timer**" to check the current time.

## 14. Turntable Reset Function

When cooking finished, if the turntable is not at the initial position, it will enter the turntable reset function. At this time, the lamp, fan and turntable are working, LED enters dynamic display. The oven stops working and reminds cooking finished.

Note:

- 1) This function only works for one completed cooking. If pause or open the door during cooking or it cannot use the reset function.
- 2) Under the reset status, press door open button or stop/cancel button will back to waiting state.
- 3) Reset position precision: cooking time in 5 minutes and turntable degrees within 30 degrees.



# OPERATION INSTRUCTIONS

## 15. Lock-out Function for Children

Lock: In waiting state, press " **Stop/Clear** " for 3 seconds, there will be a long "beep" denoting entering into the children-lock state and locked indicator will light. Screen will display current time or 0:00.

Lock quitting: In locked state, press " **Stop/Clear** " for 3 seconds, there will be a long "beep" denoting that the lock is released, and the locked indicator will disappear.

## 16. Specification

- 1) The buzzer will sound once when turning the knob at the beginning;
- 2) " **Start/+30Sec./Confirm** " must be pressed to continue cooking if the door is opened during cooking;
- 3) Once the cooking programme has been set , " **Start/+30Sec./Confirm** " is not pressed in 5 minutes. The current time will be displayed. The setting will be cancelled.
- 4) The buzzer sounds once by efficient press, inefficient press will be no response.
- 5) The buzzer will sound five times to remind you when cooking is finished.

# TROUBLE SHOOTING

Normal	
Microwave oven interfering TV reception	Radio and TV reception may be interfered when microwave oven operating. It is similar to the interference of small electrical appliances, like mixer, vacuum cleaner, and electric fan. It is normal.
Dim oven light	In low power microwave cooking, oven light may become dim. It is normal.
Steam accumulating on door, hot air out of vents	In cooking, steam may come out of food. Most will get out from vents. But some may accumulate on cool place like oven door. It is normal.
Oven started accidentally with no food in.	It is forbidden to run the unit without any food inside. It is very dangerous.

Trouble	Possible Cause	Remedy
Oven can not be started.	(1) Power cord not plugged in tightly.	Unplug. Then plug again after 10 seconds.
	(2) Fuse blowing or circuit breaker works.	Replace fuse or reset circuit breaker (repaired by professional personnel of our company)
	(3) Trouble with outlet.	Test outlet with other electrical appliances.
Oven does not heat.	(4) Door not closed well.	Close door well.



According to Waste of Electrical and Electronic Equipment (WEEE) directive, WEEE should be separately collected and treated. If at any time in future you need to dispose of this product please do NOT dispose of this product with household waste. Please send this product to WEEE collecting points where available.

PN:16170000A72246