

# TOSHIBA

## FRONT LOADING WASHER DRYER

### OWNER'S MANUAL

**MODEL**

**TWD-BK90S2 Series**

Read This Manual

Read and follow the instructions carefully.  
Keep the operation instructions handy for  
future use .



CAUTION: HOT SURFACE!



CAUTION: RISK OF FIRE!

# CONTENTS

---

## SAFETY INSTRUCTIONS

- Safety Instructions ..... 2

## INSTALLATION

- Product Description ..... 10
- Installation ..... 11

## OPERATIONS

- Quick Start ..... 15
- Before Each Washing ..... 16
- Detergent Dispenser ..... 17
- Control Panel ..... 18
- Option ..... 19
- Programmes ..... 23

## MAINTENANCES

- Cleaning And Care ..... 24
- Trouble Shooting ..... 27
- Technical Specifications ..... 28

# SAFETY INSTRUCTIONS

---

## ■ Safety Instructions

- This appliance is not intended for use by persons (including children) with reduced physical, sensory or mental capabilities or lack of experience and knowledge unless they have been given supervision or instruction concerning use of the appliance by a person responsible for their safety.
- Children should be supervised to ensure that they do not play with the appliance.
- If the supply cord is damaged, it must be replaced by the manufacturer, its service agent or similarly qualified persons in order to avoid a hazard.
- The new hose-sets supplied with the appliance are to be used and that old hose-sets should not be reused.
- The openings must not be obstructed by a carpet.
- This appliance is intended to be used in household
- The maximum permissible inlet water pressure, 1 MPa, for appliances intended to be connected to the water mains. The minimum permissible inlet water pressure, 0.05 MPa, if this is necessary for the correct operation of the appliance.

# SAFETY INSTRUCTIONS

---

## ■ Safety Instructions

For your safety, the information in this manual must be followed to minimize the risk of fire or explosion, electric shock, or to prevent property damage, personal injury or loss of life.

Explanation of the symbols:

### **Warning!**

This combination of symbol and signal word indicates a potentially dangerous situation which may result in death or serious injuries unless it's avoided.

### **Caution!**

This combination of symbol and signal word indicates a potentially dangerous situation which may result in slight or minor injuries or damage to property and the environment.

### **Note!**

This combination of symbol and signal word indicates a potentially dangerous situation which may result in slight or minor injuries.

### **Warning!**

The electric shock!

- If the supply cord is damaged, it must be replaced by the manufacturer, its service agent or similarly qualified persons in order to avoid a hazard.

# SAFETY INSTRUCTIONS

---

- The new hose-sets supplied with the appliance must be used and the old hose-sets must not be used.
- Before maintenance, unplug the appliance.
- Always unplug the machine and turn off the water supply after use. The standard inlet water pressure: 0.05MPa~1MPa.
- This appliance must be grounded. In the event of malfunction or breakdown, grounding will reduce the risk of electric shock by providing a path of least resistance for electric current.
- This appliance is equipped with a cord having an equipment-grounding conductor and grounding plug. The plug must be plugged into an appropriate outlet that is properly installed and grounded in accordance with all local codes and ordinances.
- Improper connection for the appliance when using not grounded outlet or when GND terminal of outlet is not suitable with GND terminal of power plug, can result in risk of electric shock.. Check with a qualified electrician or service person if you are in doubt as to whether the appliance is properly grounded.
- Do not modify the plug provided with the appliance. If it does not fit the outlet, have a proper outlet installed by a qualified electrician.
- Make sure that the water and electrical devices must be connected by a qualified technician in accordance with the manufacturer's instructions and local safety regulations.

# SAFETY INSTRUCTIONS

---

- Pull out its plug from the power socket before cleaning or maintenance.
- Do not use any socket with rated current less than that of appliance. Never pull out power plug with wet hand.
- Please remember to disconnect water and power supply immediately after the clothes are washed.

## **Risk to children !**

- The appliance can be used by children aged from 8 years and persons with reduced physical, sensory or mental capabilities or or lack of experience and knowledge if they have been given supervision or instruction concerning use of the appliance in a safe way and understand the hazards involved. Children shall not play with the appliance. Cleaning and user maintenance shall not be made by children without supervision.
- Children of less than 3years should be supervised to ensure that they do not play with appliance.
- Animals and children may climb into the machine. Check the machine before every operation.
- Children should be supervised that they do not play with the appliance.
- Glass door may be very hot during the operation. Keep children and pets far away from the machine during the operation .
- Remove all packages and transport bolts before using the appliance. Otherwise, serious damage may result.
- Plug must be accessible after installation.

# SAFETY INSTRUCTIONS

---

## **Risk of explosion!**

- Do not wash or dry articles that have been cleaned in, washed in, soaked in, or spotted with combustible or explosive substances( such as wax, oil, paint, gasoline, degreasers, dry-cleaning solvents, kerosene, etc.) This may result in fire or explosion.
- The washer dryer is not to be used if industrial chemicals have been used for cleaning.
- The exhaust air must not be discharged into a flue which is for exhausting fumes from appliances burning gas or other fuels.
- Rinse the articles thoroughly by hand before putting them in the appliance.



## **Caution!**

## **Installing the product!**

- The appliance is for indoor use only.
- It isn't intended to be built-in using.
- The openings must not be obstructed by a carpet.
- The appliance shall not be installed in bath room or very wet rooms as well as in the rooms with explosive or explosive and corrosive gases.
- The appliance with single inlet valve only can be connected to the cold water supply.
- Plug must be accessible after installation.
- The appliance must not be installed behind a lockable door, a sliding door or a door with a hinge on the opposite side to that of the washer dryer.
- The appliance shall not be installed at a humid place.
- The household appliance isn't intended to be built-in.

# SAFETY INSTRUCTIONS

---

- Remove all packages and transport bolts before using the appliance. Otherwise, serious damage may result.

## **Risk of damaging appliance!**

- Your product is only for home use and is only designed for the textiles suitable for machine washing.
- Do not climb up and sit on top cover of the machine.
- Do not lean against machine door.
- Cautions during Handling Machine:
  - 1.Transport bolts shall be reinstalled to the machine by a specialized person.
  - 2.The accumulated water shall be drained out of the machine.
  - 3.Handle the machine carefully. Never hold each protruded part on the machine while lifting. Machine door can not be used as the handle during the conveyance.
  - 4.This appliance is heavy. Transport with care.
  - 5.That the hands shall not be inserted into running water extracting tub.
- Please do not close the door with excessive forces. If it is found difficult to close the door, please check if the clothes are put in or distributed well.
- It is forbidden to wash carpets.

## **Operating the appliance!**

- Before washing the clothes at first time, the product shall be operated in one round of the whole procedures without the clothes inside.The suggested program is "DRUM CLEAN".
- Flammable and explosive or toxic solvents are forbidden. Gasoline and alcohol etc.Shall not be used as detergents. Please only select the detergents suitable for machine washing, especially for front load washing machine.



# SAFETY INSTRUCTIONS

---

- Make sure that all pockets are emptied. Sharp and rigid items such as coin, brooch, nail, screw or stone etc. may cause serious damages to this machine.
- Please check whether the water inside the drum has been drained before opening its door. Please do not open the door if there is any water visible.
- Be careful of burning when the product drains hot washing water.
- Never refill the water by hand during washing.
- After the program is completed, Please wait for two minutes to open the door.
- If it is unavoidable that fabrics that contain vegetable or cooking oil or have been contaminated by hair care products. If they are placed in a tumble dryer they should first be washed in hot water with extra detergent, this will reduce, but not eliminate, the hazard.
- Adequate ventilation has to be provided to avoid the back flow of gases into the room from appliances burning other fuels, including open fires.
- Do not dry unwashed items in the appliance. Items that have been soiled with substances such as cooking oil, acetone, alcohol, petrol, kerosene, spot removers, turpentine, waxes and wax removers should be washed in hot water with an extra amount of detergent before being dried in the appliance.
- Items such as foam rubber (latex foam), shower caps, water proof textiles, rubber backed articles and clothes or pillows fitted with foam rubber pads should not be dried in the machine.

# SAFETY INSTRUCTIONS

---

- Fabric softeners, or similar products, should be used as specified by the fabric softener instructions.
- The final part of a washer dryer cycle occurs without heat (cool down cycle) to ensure that the items are left at a temperature that ensures that the items will not be damaged.
- Remove all objects from pockets such as lighters and matches before use the appliance.
- **WARNING:** Never stop a washer dryer before the end of the drying cycle unless all items are quickly removed and spread out so that the heat is dissipated.

## Packaging/Old appliance



This marking indicates that this product should not be disposed with other household wastes through out the EU. To prevent possible harm to the environment or human health from uncontrolled waste disposal, recycle it responsibly to promote the sustainable reuse of material resources. To return your used device, please use the collection systems or contact the retailer where the product was purchased. They return and can take this product for environmental safe recycling.

# INSTALLATION

## ■ Product Description

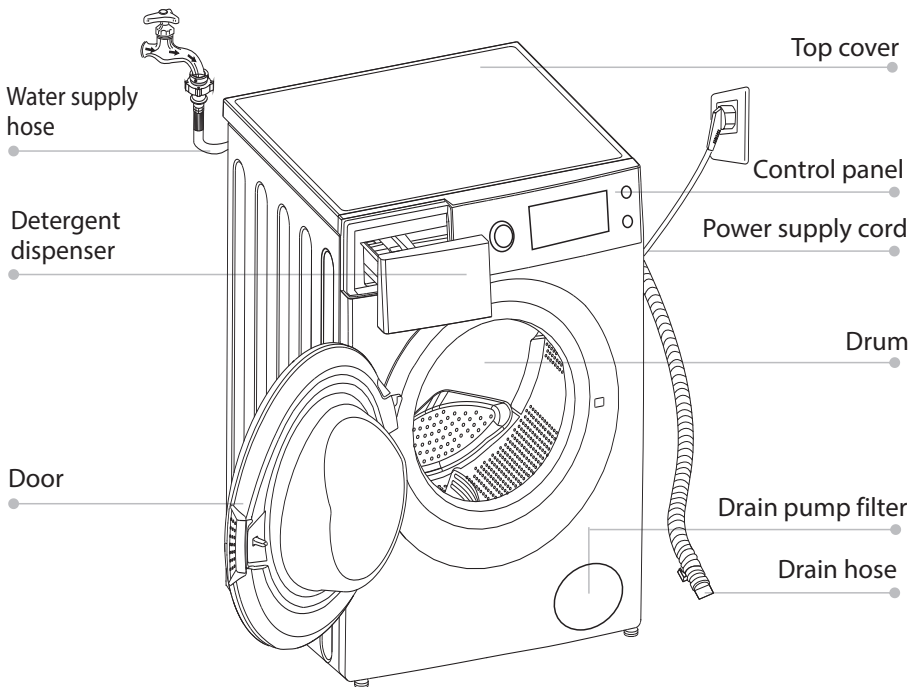

### **Note!**

- The product line chart is for reference only, please refer to real product as standard.

## Accessories



Transport  
hole plug

Supply hose  
cold water

Drain hose  
support  
(optional)

Owner's manual

Rat resistance  
panel(optional)

Spanner assembly  
(optional)

Screw(optional)

# INSTALLATION

## ■ Installation

### Installation area

#### **Warning!**

- Stability is important to prevent the product from wandering!
- Make sure that the product should not stand on the power cord.

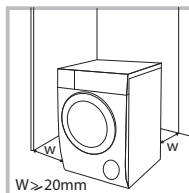

Before installing the machine, the location characterized as follows shall be selected:

1. Rigid, dry, and level surface
2. Avoid direct sunlight
3. Sufficient ventilation
4. Room temperature is above 0°C
5. Keep far away from the heat resources such as coal or gas.

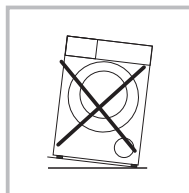

### Unpacking the washing machine

#### **Warning!**

- Packaging material (e.g. Films, Styrofoam) can be dangerous for children.
- There is a risk of suffocation ! Keep all packaging well away from children.

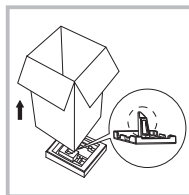

1. Remove the cardboard box and styrofoam packing.
2. Lift the washing machine and remove the base packing. Make sure the small triangle foam is removed with the bottom one together. If not, lay the unit down with side surface, then remove the small foam from the unit bottom manually.
3. Remove the tape securing the power supply cord and drain hose.
4. Remove the inlet hose from the drum.

### Remove transport bolts

#### **Warning!**

- You must remove the transport bolts from the backside before using the product.
- You'll need the transport bolts again if you move the product, so make sure you keep them in a safe place.

Please take the following steps to remove the bolts:

1. Loosen 4 bolts with spanner and then remove them.
2. Cover the hole with transport hole plugs.
3. Keep the transport bolts properly for future use.

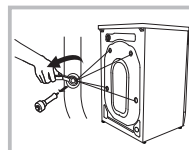

# INSTALLATION

## Levelling the washing machine

### **Warning!**

- Check with the gradienter if the machine placement is balanced and steady.
- If there is no gradienter, check the balance as per the following method.

### 1.If it's balanced from left to right.

- Take a long stick, and tie a rope at the end of it. Bind a heavy object at the end of the rope.
- Hang the rope from the top cover of the machine. Adjust the legs till the difference between 'a' and 'b' is less than 1 cm.

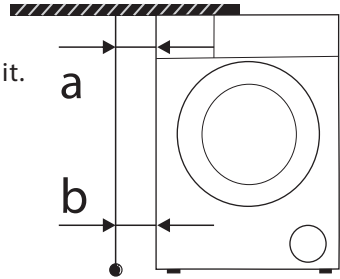

### 2.If it's balanced from front to back

- Put the stick at the middle of the control panel, and hang the rope in front of the machine.
- Keep 10cm away from the rope end to the control panel edge. Adjust the legs till 'c' is 3.5~4.5cm ('c' is the distance from rope to bottom of front cover).

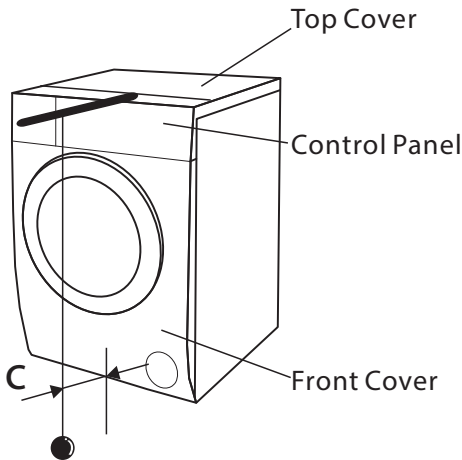

# INSTALLATION

## Levelling the washing machine

### **Warning!**

- The lock nut on all four feet must be screwed tightly against the housing.

1. Check if the legs are closely attached to the cabinet. If not, please turn them to their original positions tighten the nuts.
2. Loosen the lock nut turn the feet until it closely contacts with the floor.
3. Adjust the legs and lock them with a spanner, make sure the machine is steady.

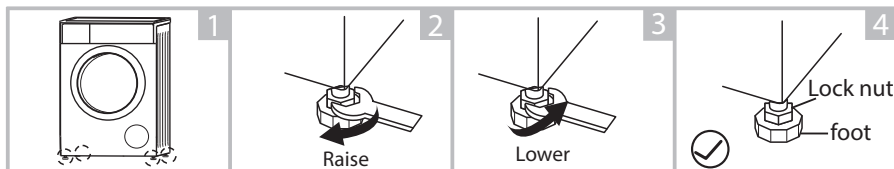

## Connect Water Supply Hose

### **Warning!**

- To prevent leakage or water damage, follow the instructions in this chapter!
- Do not kink, crush, modify or sever water inlet hose.

Connect the inlet pipe as indicated, There are two ways to connect the inlet pipe.

1. Connection between ordinary tap and inlet hose.

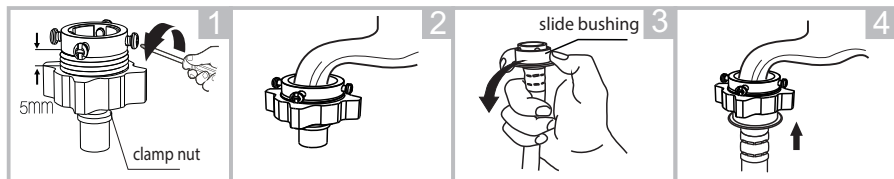

Loosen clamp nut and four bolts

Press the tap end tightly to the rubber ring inside the clamp, and then, tighten the 4 bolts

Press slide bushing, insert inlet hose into connecting base

Connection finished

2. Connection between screw tap and inlet hose.

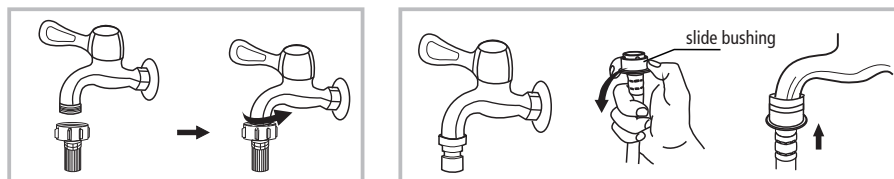

Tap with threads and inlet hose

Special tap for washing machine

# INSTALLATION

Connect the other end of inlet pipe to the inlet valve at the backside of product and fasten the pipe tightly clockwise.

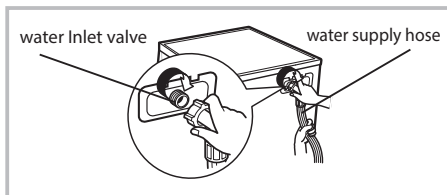

## Drain Hose

### ⚠ Warning!

- Do not kink or protract the drain hose.
- Position drain hose properly ,otherwise damage might result of water leakage.

There are two ways to place the end of drain hose:

1.Put it into the drain port.

2.Connect it to the branch drain pipe of the trough.

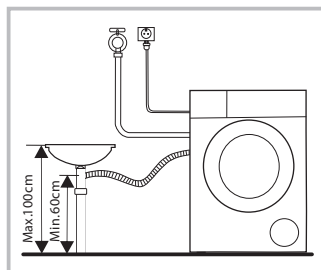
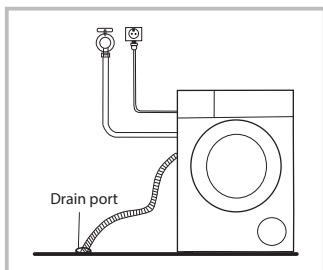

### 📌 Note!

- If the machine has drain hose support, please install it like the following .

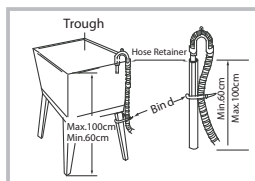
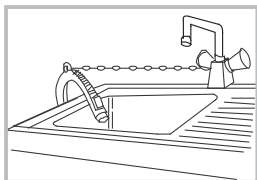

### ⚠ Warning!

- When installing drain hose, fix it properly with a rope.
- If drain hose is too long, do not force it into washing machine as it will cause abnormal noises.

# OPERATIONS

## ■ Quick Start

### ⚠ Caution!

- Before washing, please make sure it's installed properly.
- Before washing at first time, the washing machine shall be operated in one round of the whole procedures without clothes in as follows. The suggested program is "DRUM CLEAN".

## 1. Before Washing

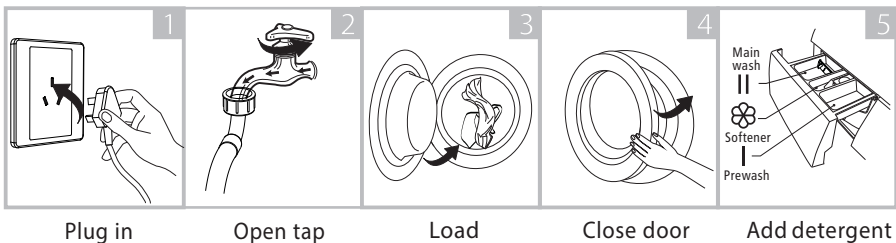

### 📌 Note!

- Detergent needs to be added in "case I" only when pre-washing option is selected.

## 2. Washing

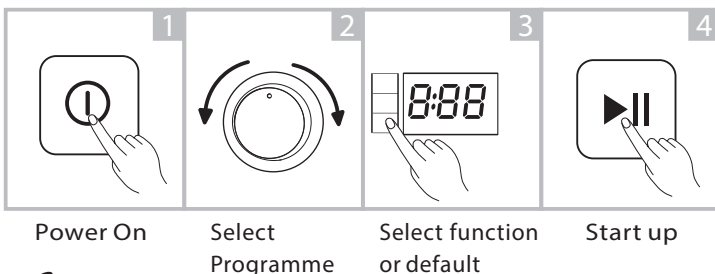

### 📌 Note!

- If default is selected, step 3 can be skipped.

## 3. After Washing

Buzzer beep or "End" on display.



# OPERATIONS

## ■ Before Each Washing

- The working condition of the washer should be (0-40)°C. If used under 0°C, the inlet valve and draining system may be damaged. If the machine is placed under condition of 0°C or less, then it should be transferred to normal ambient temperature to ensure the water supply hose and drain hose are not frozen before use.
- Please check the labels and the explanation of using detergent before wash. Use non-foaming or less-foaming detergents suitable for machine washing properly.

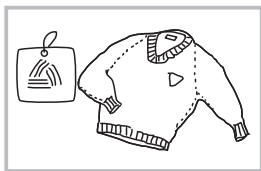

Check the label

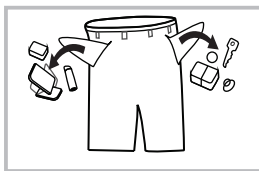

Take out the items out of the pockets

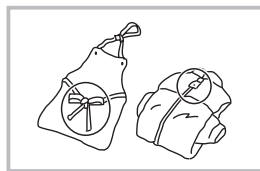

Knot the long strips, zip or button

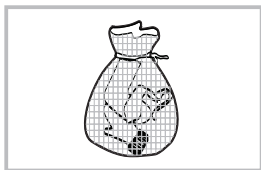

Put small clothes into the pillow slip

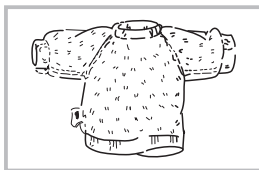

Turn easy-pilling and long-pile fabric inside out

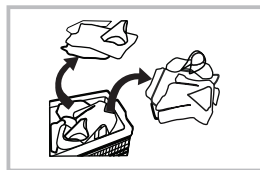

Separate clothes with different textures

### Warning!

- When washing a single clothes, it may easily cause great imbalance and give alarm. Therefore it is suggested to add one or two more clothes to be washed together so that washing process can be done smoothly.
- Don't wash the clothes soaked in kerosene, gasoline, alcohol and other flammable materials.

# OPERATIONS

## ■ Detergent Dispenser

- I Pre wash detergent
- II Main wash detergent
- ☼ Softener

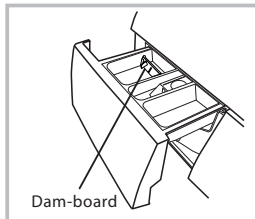

Liquid detergent

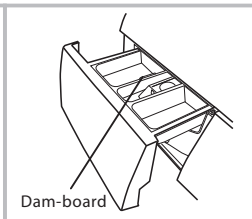

Powder detergent

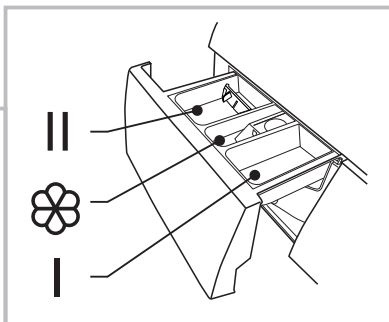

Pull out the dispenser

Programme	I	II	☼	Programme	I	II	☼
COTTON		●	○	COTTON ECO		●	○
SYNTHETIC		●	○	COLORALIVE		●	○
MIX		●	○	15' QUICK		●	○
TIME DRY				WOOL		●	○
AUTO DRY				SPIN ONLY			
1 HOUR W/D		●	○	RINSE&SPIN			○
BABY CARE		●	○	SPORTWEAR		●	○
DRUM CLEAN							

● Means must      ○ Means optional

### 📌 Note!

- As for the agglomerated or ropy detergent or additive, before they are poured into the detergent box, it is suggested to use some water for dilution to prevent the inlet of detergent box from being blocked and overflowing while filling water.
- Please choose suitable type of detergent for the various washing temperature to get the best washing performance with less water and energy consumption.

# OPERATIONS

## ■ Control Panel

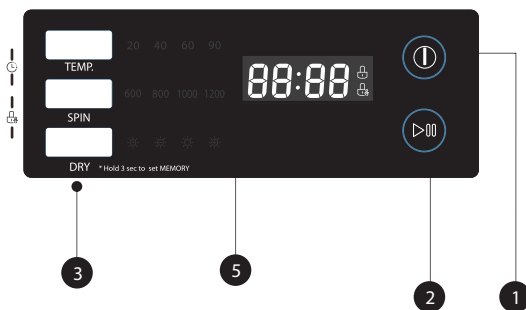
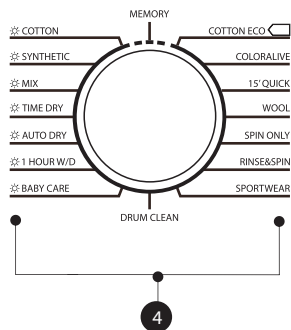

### Note!

- The chart is for reference only, Please refer to real product as standard.

#### 1 On/Off

Product is switched on or off.

#### 2 Start/Pause

Press the button to start or pause the washing cycle.

#### 3 Option

This allows you to select an additional function and will light when selected.

#### 4 Programmes

Available according to the laundry type.

#### 5 Display

The display shows the estimated time remaining and lock messages for your washer. The display will remain on through the cycle.



A Door Lock

B Child Lock

# OPERATIONS

---

## ■ Option

---



### DRY

It is suitable for different level of drying .

For [AUTO DRY] , The default level is 6:00 ,when touch drying button, drying level will be changed (6:00 → 6:20 →5:40).

For [TIME DRY] , The default is 0:40 ,when touch drying button, the drying time will be changed (0:40→1:10→1:40→2:10)



### Note!

- Drying hints
  - Clothes could be dried after spinning
  - To ensure quality dry the textiles, please classify them according to their kinds and the drying temperature.
  - Synthetic should be set the proper drying time .
  - If you want to iron the clothes after drying, please put them for a while.
- Clothes not suitable for drying
  - Particularly delicate items such as synthetic curtains, woolen and silk, clothes with metal inserts, nylon stockings, bulky clothes, such as anoraks, bedcovers, quilts, sleeping bags and duvets must not be dried.
  - Clothes padded with foam-rubber or materials similar to foam-rubber must not be machine dried.
  - Fabrics containing residues of setting lotions or hair sprays, nail solvents or similar solutions must not be machine dried in order to avoid the formation of harmful vapours.



### MEMORY

Memorizes the frequently used program.

Select program and options and Press [DRY] 3 sec. The default Program is COTTON. The program after selection will cover the previous program.

# OPERATIONS



## Child Lock

To avoid mis operation by children.

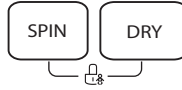

On/Off

Start/Pause

Press [SPIN] and [DRY]

3 sec. till buzzer beep.



## Caution!

- Press the two button 3sec. also to be released the function.
- The “Child Lock” will lock all buttons except [ On/Off ].
- Cut off the power supply , the kid’s protection is to be released.
- The child lock will remain effective when the power is resumed for some models.



## SPIN

Press the button to change the spin speed.

Programme	Default Speed(rpm)	Programme	Default Speed(rpm)
COTTON	800	COTTON ECO	1000
SYNTHETIC	800	COLORALIVE	1000
MIX	800	15' QUICK	800
TIME DRY	1200	WOOL	800
AUTO DRY	1200	SPIN ONLY	1000
1 HOUR W/D	1200	RINSE&SPIN	1000
BABY CARE	800	SPORTWEAR	800
DRUM CLEAN	--		



## Caution!

- When the lights of spin speed (600,800,1000,1200) is off, it means no spin process.



## TEMP.

Press the button to regulate the temperature.

All the lights are off means the water temp. is cold.

# OPERATIONS



## DELAY END

Set the Delay function:

1. Select a programme
2. Press the [TEMP.]&[SPIN] button to choose the time (the delaying end time is 1-24 H.)
3. Press [START/PAUSE] to commence the delay operation

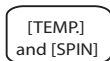

ON/OFF

Choose the Programme

Setting time

Start

Cancel the Delay function:

Press the [TEMP.] and [SPIN] button until the display be 0H. It should be pressed before starting the programme. If the programme already started, should press the [ON/OFF] button to reset the programme.



## Caution!

- If there is any break in the power supply while the machine is operating, a special memory stores the selected programme and when the power is restarted, the machine will run the previous program automatically.
- While the machine is delaying, if there is any break in the power supply, the machine can't start up operation automatically. You should set it again.

Programme	Option			
	TEMP.	SPIN	DRY	DELAY END
COTTON	<input type="radio"/>	<input type="radio"/>	<input type="radio"/>	<input type="radio"/>
SYNTHETIC	<input type="radio"/>	<input type="radio"/>	<input type="radio"/>	<input type="radio"/>
MIX	<input type="radio"/>	<input type="radio"/>	<input type="radio"/>	<input type="radio"/>
TIME DRY		<input type="radio"/>	<input type="radio"/>	<input type="radio"/>
AUTO DRY		<input type="radio"/>	<input type="radio"/>	<input type="radio"/>
1 HOUR DRY				<input type="radio"/>
BABY CARE	<input type="radio"/>	<input type="radio"/>	<input type="radio"/>	<input type="radio"/>
DRUM CLEAN				<input type="radio"/>
SPORTWEAR	<input type="radio"/>	<input type="radio"/>		<input type="radio"/>
RINSE&SPIN		<input type="radio"/>		<input type="radio"/>
SPIN ONLY		<input type="radio"/>		<input type="radio"/>
WOOL	<input type="radio"/>	<input type="radio"/>		<input type="radio"/>
15' QUICK	<input type="radio"/>	<input type="radio"/>		<input type="radio"/>
COLORALIVE	<input type="radio"/>	<input type="radio"/>		<input type="radio"/>
COTTON ECO	<input type="radio"/>	<input type="radio"/>		<input type="radio"/>

Means optional

# OPERATIONS

## ■ Programmes Programmes are available according to the laundry type.

COTTON	Hard-wearing textiles, heat-resistant textiles made of cotton or linen.
BABY CARE	Washing the baby's clothes, it can make the baby's wear cleaner and make the rinse performance better to protect the baby skin.
MIX	Mixed load consisting of textiles made of cotton and synthetics.
15' QUICK	This procedure is suitable for washing few and not very dirty clothes quickly.
COTTON ECO	To increase the washing effects, washing time is increased.
MEMORY	Press [DRY] for 3sec. to set the memory program, the default memory is COTTON
1 HOUR W/D	For small synthetic clothes or shirts, load limitation is 1 kg (about 4 shirts).
AUTO DRY	This program is designed for drying clothes automatically to achieve the best dry performance. You can touch DRYING button to change the drying level(6:00, 6:20:5:40)
SPIN ONLY	Extra spin with selectable spin speed.
WOOL	Hand or machine-washable wool or richwool textiles. Especially gentle wash programme to prevent shrinkage, longer programme pauses (textiles rest in wash liquor).
DRUM CLEAN	This program is specially set in this machine to clean the drum and tube. It applies 90°C high temperature sterilization to make the clothes washing more green. When this procedure is performed, the clothes or other washing cannot be added. When proper amount of chlorine bleaching agent is put in, the barrel cleaning effect will be better. The customer can use this procedure regularly according to the need.
SPORTWEAR	Washing the activewear.
SYNTHETIC	Wash synthetic articles, for example: shirts, coats, blending. While washing the knitting textiles, detergent quantity shall be reduced due to its loose string construction and easily forming bubbles.
TIME DRY	This program can choose the drying time.
RINSE&SPIN	Extra rinse with spin.
COLORALIVE	Washing brightly colored clothes, it can protect the colors better.

# OPERATIONS

## ■ Washing Programmes Table

Programme	Load(kg)	Temp.(°C)	Default Time
	8.0	Default	
COTTON ECO	8.0	40	2:36
COLORALIVE	4.0	20	3:47
15' QUICK	2.0	Cold	0:15
WOOL	2.0	40	1:07
SPIN ONLY	8.0	--	0:12
RINSE&SPIN	8.0	--	0:20
SPORTWEAR	4.0	20	0:45
DRUM CLEAN	--	90	1:10
BABY CARE	8.0	60	1:45
1 HOUR W/D	1.0	--	0:59
AUTO DRY	5.0	--	6:00
TIME DRY	1.0	--	0:40
MIX	8.0	40	1:10
SYNTHETIC	4.0	40	2:20
COTTON	8.0	40	2:40

### Note!

- The parameters in this table are only for user's reference. The actual parameters maybe different with the parameters in above mentioned table.



# MAINTENANCES

---

## ■ Cleaning And Care

### Warning!

- Before your maintenance starts, please unplug the machine and close the tap.

## Cleaning The Cabinet

Proper maintenance on the washing machine can extend its working life. The surface can be cleaned with diluted non-abrasive neutral detergents when necessary. If there is any water overflow, use the dry cloth to wipe it off immediately. No sharp items are allowed.



### Note!

- Formic acid and its diluted solvents or equivalent are forbidden, such as alcohol, solvents or chemical products, etc.

## Cleaning The Drum

The rusts left inside the drum by the metal articles shall be removed immediately with chlorine-free detergents. Never use steel wool.

### Note!

- Don't put laundry in the washing machine during the drum cleaning.

## Cleaning The Gasket And Glass

Wipe the glass and gasket after each wash to remove lint and stains. If lint builds up it can cause leaks. Remove any coins, buttons and other objects from the gasket after each wash.

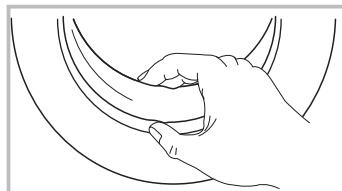

# MAINTENANCES

## Cleaning The Inlet Filter

### Note!

- Inlet filter must be cleaned if there is less water.

Washing the filter in the water supply hose

1. Close the tap.
2. Remove water supply hose from the tap.
3. Clean the filter.
4. Reconnect the water supply hose.

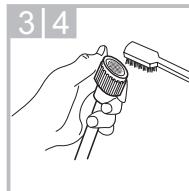
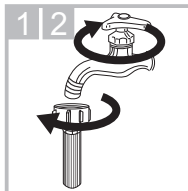

Washing the filter in washing machine:

1. Screw off the inlet pipe from the backside of the machine.
2. Pull out the filter with long nose pliers and reinstall it back after being washed.
3. Use the brush to clean the filter.
4. Reconnect the inlet pipe.

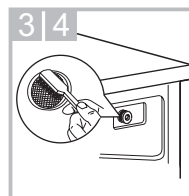
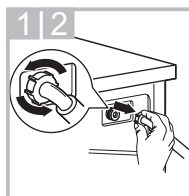

## Clean The Detergent Dispenser

1. Press down the arrow location on softener cover inside the dispenser drawer.
2. Lift the clip up and take out softener cover and wash all grooves with water.
3. Clean inside the recess with a suitable brush such as an old toothbrush.
4. Restore the cover and push the drawer into position

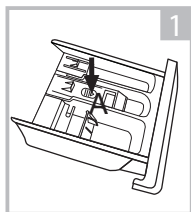

Pull out the dispenser drawer with press the A

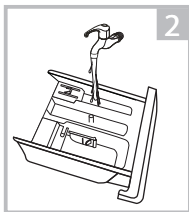

Clean the dispenser drawer under water

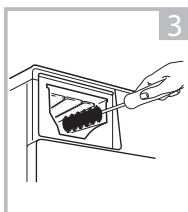

Clean inside the recess with an old toothbrush

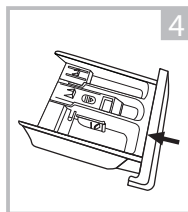

Insert the dispenser drawer

### Note!

- Do not use alcohol, solvents or chemical products to clean the machine.

# MAINTENANCES

## Cleaning The Drain Pump Filter

### ⚠ Warning!

- Be careful of the hot water!
- Allow the water to cool down.
- Unplug the machine to avoid electrical shock before maintenance.
- Drain pump filter can filter the lints and small foreign matters from the washing.
- Clean the filter periodically to ensure the normal operation of washing machine.

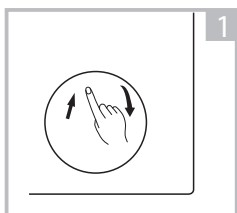

Open the lower cover cap

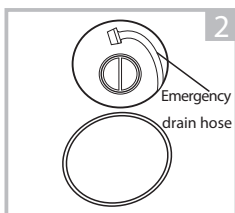

Pull out the emergency drain hose, and take off the hose cap

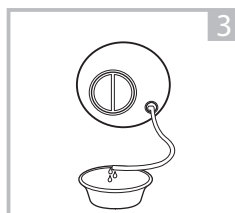

After water runs out, reset the drain hose

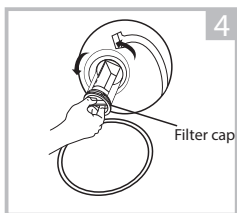

Open the filter cap by turning to the counter clockwise

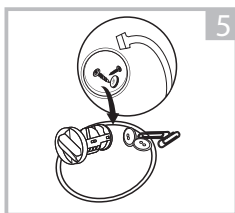

Remove extraneous matter

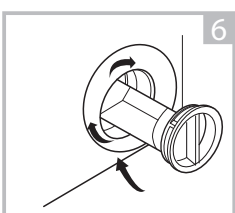

Close the filter cap and the lower cover cap

### ⚠ Caution!

- Make sure that filter cap and emergency drain hose are reinstalled properly, filter cap should be inserted aligning to hole plates otherwise water may leak.
- When the appliance is in use and depending on the programme selected there can be hot water in the pump. Never remove the pump cover during a wash cycle, always wait until the appliance has finished the cycle, and is empty. When replacing the filter cap, ensure it is securely re-tightened.

# MAINTENANCES

## ■ Trouble Shooting

The start of the appliance does not work or it stops during operation. First try to find a solution to the problem, If not, contact the service centre.

Description	Reason	Solution
Washing machine cannot start up	Door is not closed properly	Restart after the door is closed Check if the clothes is stuck
Door can't be opened	Washer's safety protection design is working	Disconnect the power, restart the product
Water leakage	The connection between inlet pipe or outlet hose is not tight	Check and fasten water pipes Check outlet hose
Detergent residues in the box	Detergent is dampened or agglomerated	Clean and wipe the detergent box
Indicator or display does not light	Electrical power cord may not be plugged in or connection may be loose.	Make sure plug fits tightly in wall outlet. Check the power plug is connected correct.
Abnormal noise		Check if the fixing (bolts) have been removed Check it's installed on a solid and level floor

Description	Reason	Solution
E30	Door is not closed properly	Restart after the door is closed Check if the clothes is stuck
E10	Water injecting problem while washing	Check if the water pressure is too low Straighten the water pipe Check if the inlet valve filter is blocked
E21	Overtime water draining	Check if the drain hose is blocked
E12	Water overflow	Stop using the washing machine and call the service center for repair
EXX	Others	Please try again first, call up service line if there are still troubles

### Note!

- After the check, activate the appliance. If the problem occurs or the display shows other alarm codes again, contact the service.

# MAINTENANCES

## ■ Technical Specifications

Power Supply 220-240V~,50Hz

MAX.Current 10A

Standard Water Pressure 0.05MPa~1MPa

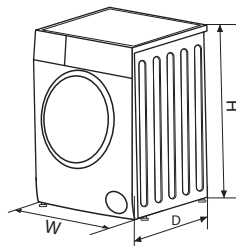

Model	Washing Capacity	Dry Capacity	Dimension (W*D*H mm)	Net Weight	Rated Power	Dry Power
TWD-BK90S2 Series	8.0kg	5.0kg	595*600*850	72kg	2000W	1300W