

INSTRUCTION MANUAL

MICROWAVE OVEN

ML3-SEC34SF(BK)

Please review this instruction manual before operating.

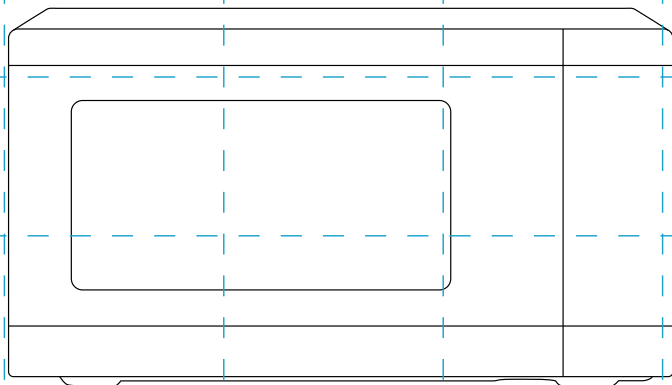

TOSHIBA

CONTENTS

PRODUCT SAFETY

Precautions to avoid possible exposure to excessive microwave energy	EN-01
Specifications	EN-02
Important safety instructions	EN-03
To reduce the risk of injury to persons grounding installation	EN-08
Cleaning	EN-10
Utensils.....	EN-11
Materials you can use in microwave oven	EN-12
Materials can not be used in microwave oven	EN-14

PRODUCT SETTING

Names of microwave oven parts and accessories	EN-15
Turntable installation	EN-16
Countertop installation	EN-17
Installation	EN-17

INSTRUCTION FOR USE

Before using for the first time	EN-18
Operation	EN-19
Control panel and features	EN-19
1. Standby mode	EN-20
2. Setting the clock	EN-20
3. Setting the kitchen timer	EN-21
4. Microwave cooking.....	EN-21
5. Grill cooking	EN-23
6. Combination cooking.....	EN-24
7. Defrost by time	EN-26
8. Defrost by weight	EN-27

9. Convection cooking with preheat function	EN-28
10. Convection cooking without preheat function	EN-29
11. Multi-stage cooking	EN-31
12. Speedy cooking	EN-32
13. Auto menu	EN-32
14. Airfry menu	EN-35
15. Inquiring function	EN-37
16. Eco function	EN-37
17. Wireless connection	EN-37
Recipes	EN-38
FAQ	EN-39

CLEANING AND MAINTENANCE

Cleaning	EN-40
Trouble shooting	EN-42



NOTE

BEFORE OPERATING THIS PRODUCT, READ, UNDERSTAND, AND FOLLOW THESE INSTRUCTIONS. BE SURE TO SAVE THIS BOOKLIST FOR FUTURE REFERENCE.

PRECAUTIONS TO AVOID POSSIBLE EXPOSURE TO EXCESSIVE MICROWAVE ENERGY

- (a). Do not attempt to operate this oven with the door open since this can result in harmful exposure to microwave energy. It is important not to break or tamper with the safety interlocks.
- (b). Do not place any object between the oven front face and the door or allow soil or cleaner residue to accumulate on sealing surfaces.
- (c). **WARNING:** If the door or door seals are damaged, the oven must not be operated until it has been repaired by a competent person.

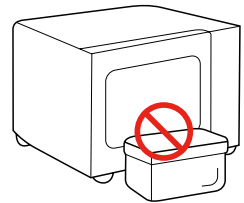

ADDENDUM

If the apparatus is not maintained in a good state of cleanliness, its surface could be degraded and affect the lifespan of the apparatus and lead to a dangerous situation.

SPECIFICATIONS

MODEL	ML3-SEC34SF(BK)
RATED VOLTAGE/FREQUENCY	230-240 V~ 50 Hz
MICROWAVE INPUT POWER	1800 W
MICROWAVE OUTPUT POWER	1100 W
GRILL	1100 W
CONVECTION	2100 W



NOTE

All pictures in this manual are for illustrative purposes only; these may be slightly different from the purchased equipment, please refer to the actual product.

IMPORTANT SAFETY INSTRUCTIONS



WARNING

To reduce the risk of fire, electric shock, injury to persons or exposure to excessive microwave oven energy when using your appliance, follow basic precautions, including the following:



Read and follow the specific: "**PRECAUTIONS TO AVOID POSSIBLE EXPOSURE TO EXCESSIVE MICROWAVE ENERGY**".



This appliance is not intended for use by persons (including children) with reduced physical, sensory or mental capabilities, or lack of experience and knowledge, unless they have been given supervision or instruction concerning use of the appliance by a person responsible for their safety.



Children should be supervised to ensure that they do not play with the appliance.

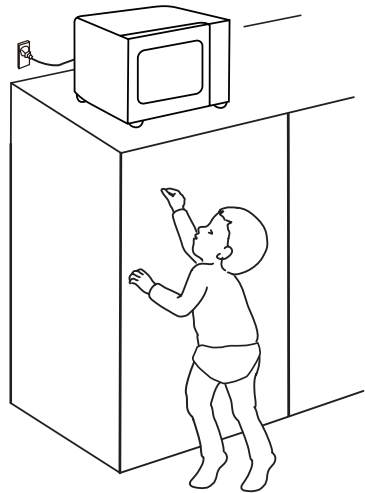



If the supply cord is damaged, it must be replaced by the

IMPORTANT SAFETY INSTRUCTIONS

manufacturer, its service agent or similarly qualified persons in order to avoid a hazard.

 **WARNING:** Ensure that the appliance is switched off before replacing the lamp to avoid the possibility of electric shock.

 **WARNING:** It is hazardous for anyone other than a competent person to carry out any service or repair operation that involves the removal of a cover which gives protection against exposure to microwave energy.

 **WARNING:** Liquids and other foods must not be heated in sealed containers since they are liable to explode.

 When heating food in plastic or paper containers, keep an eye on the oven due to the possibility of ignition.

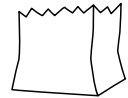

 Only use utensils that are suitable for use in microwave ovens.

 If smoke is emitted, switch off or unplug the appliance and keep the door closed in order to stifle any flames.

 Microwave heating of beverages can result in delayed eruptive boiling, therefore care must be taken when handling the container.

 The contents of feeding bottles and baby food jars shall be stirred or shaken and the temperature

IMPORTANT SAFETY INSTRUCTIONS

checked before consumption, in order to avoid burns.

 The oven should be cleaned regularly and any food deposits removed. Please keep the waveguide area clean. Use soft damp cloth to clean it up when there is food splash residue on the waveguide area or the cavity. Failure to clean food residue may cause innocuous sparking or some smoke in the microwave cavity, discoloration of the cavity may also occur.

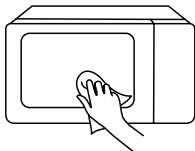

 Failure to maintain the oven in a clean condition could lead to deterioration of the surface that could adversely affect the life of the appliance and possibly

result in a hazardous situation.

 Only use the temperature probe recommended for this oven. (For ovens provided with a facility to use a temperature-sensing probe.)

 The microwave oven must be operated with the decorative door open. (For ovens with a decorative door.)

 This appliance is intended to be used in household and similar applications such as:

1. staff kitchen areas in shops, offices and other working environments;
2. by clients in hotels, motels and other residential type environments;
3. farm houses;
4. bed and breakfast type environments.

IMPORTANT SAFETY INSTRUCTIONS

 The microwave oven is intended for heating food and beverages. Drying of food or clothing and heating of warming pads, slippers, sponges, damp cloth and similar may lead to risk of injury, ignition or fire.

 The rear surface of appliances shall be placed against a wall.

 The temperature of accessible surfaces may be high when the appliance is operating.

 **WARNING:** When the appliance is operated in the combination mode, children should only use the oven under adult supervision due to the temperatures generated.

 The appliance is intended to be used freestanding.

 Eggs in their shell and whole hard-boiled eggs should not be heated in microwave ovens since they may explode, even after microwave heating has ended.

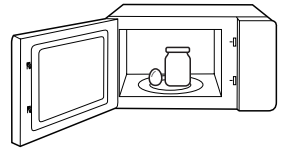

 The microwave oven shall not be placed in a cabinet unless it has been tested in a cabinet.

 Metallic containers for food and beverages are not allowed during microwave cooking.

 The appliance shall not be cleaned with a steam cleaner.

IMPORTANT SAFETY INSTRUCTIONS



The appliances are not intended to be operated by means of an external timer or separate remote-control system.



The appliance must not be installed behind a decorative door in order to avoid overheating. (This is not applicable for appliances with decorative door.)

READ CAREFULLY AND KEEP FOR
FUTURE REFERENCE
HOUSEHOLD USE ONLY
(NOT FOR COMMERCIAL USE)

TO REDUCE THE RISK OF INJURY TO PERSONS GROUNDING INSTALLATION

This appliance must be grounded. In the event of an electrical short circuit, grounding reduces the risk of electric shock by providing an escape wire for the electric current.

This appliance is equipped with a cord having a grounding wire with a grounding plug. The plug must be plugged into an outlet that is properly installed and grounded.

WARNING - Improper use of the grounding can result in a risk of electric shock. Consult a qualified electrician or serviceman if the grounding instructions are not completely understood or if doubt exists as to whether the appliance is properly grounded. If it is necessary to use an extension cord, use only a 3-wire extension cord.



DANGER

Electric Shock Hazard:
Touching some of the internal components can cause serious personal injury or death. Do not disassemble this appliance.

TO REDUCE THE RISK OF INJURY TO PERSONS GROUNDING INSTALLATION



WARNING

Electric Shock Hazard:

Improper use of the grounding can result in electric shock. Do not plug into an outlet until appliance is properly installed and grounded.

1. A short power-supply cord is provided to reduce the risks resulting from becoming entangled in or tripping over a longer cord.
2. If a long cord or extension cord is used:
 - (1). The marked electrical rating of the cord set or extension cord should be at least as great as the electrical rating of the appliance.
 - (2). The extension cord must be a grounding-type 3-wire cord.
 - (3). The longer cord should be arranged so that it will not drape over the counter top or tabletop where it can be pulled on by children or tripped over unintentionally.

CLEANING

Be sure to unplug the appliance from the power supply.

1. Clean the cavity of the oven after using with a slightly damp cloth.
2. Clean the accessories in the usual way in soapy water.
3. The door frame and seal and neighbouring parts must be cleaned carefully with a damp cloth when they are dirty.
4. Do not use harsh abrasive cleaners or sharp metal scrapers to clean the oven door glass since they can scratch the surface, which may result in shattering of the glass.
5. Cleaning Tip---For easier cleaning of the cavity walls that the food cooked can touch: Place half a lemon in a bowl, add 300ml (1/2 pint) water and heat on 100% microwave power for 10 minutes. Wipe the oven clean using a soft, dry cloth.

UTENSILS



CAUTION

Personal Injury Hazard:

It is hazardous for anyone other than a competent person to carry out any service or repair operation that involves the removal of a cover which gives protection against exposure to microwave energy. See the instructions on "**Materials you can use in microwave oven**" or "**Materials can not be used in microwave oven**".

There may be certain non-metallic utensils that are not safe to use for microwaving. If in doubt, you can test the utensil in question following the procedure below.

Utensil Test:

1. Fill a microwave-safe container with 1 cup of cold water (250ml) along with the utensil in question.
2. Cook on maximum power for 1 min.
3. Carefully feel the utensil. If the empty utensil is warm, do not use it for microwave cooking.
4. Do not exceed 1 min cooking time.

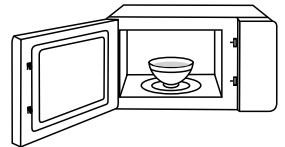





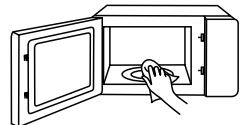











NOTE





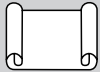



KEEP THE CAVITY AND WAVEGUIDE AREA CLEAN





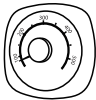







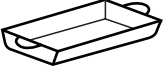



MATERIALS YOU CAN USE IN MICROWAVE OVEN

UTENSILS	REMARKS	
 Browning dish	Follow manufacturer's instructions. The bottom of browning dish must be at least 3/16 inch (5mm) above the turntable. Incorrect usage may cause the turntable to break.	
 Dinnerware	Microwave-safe only. Follow manufacturer's instructions. Do not use cracked or chipped dishes.	
 Glass jars	Always remove lid. Use only to heat food until just warm. Most glass jars are not heat resistant and may break.	
 Glassware	Heat-resistant oven glassware only. Make sure there is no metallic trim. Do not use cracked or chipped dishes.	
 Oven cooking bags	Follow manufacturer's instructions. Do not close with metal tie. Make slits to allow steam to escape.	
 Paper plates and cups	Use for short-term cooking/warming only. Do not leave oven unattended while cooking.	
 Paper towels	Use to cover food for reheating and absorbing fat. Use with supervision for a short-term cooking only.	
 Parchment paper	Use as a cover to prevent splattering or a wrap for steaming.	

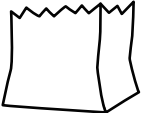
MATERIALS YOU CAN USE IN MICROWAVE OVEN

UTENSILS	REMARKS
 <p data-bbox="175 453 243 475">Plastic</p>	<p data-bbox="353 355 901 496">Microwave-safe only. Follow the manufacturer's instructions. Should be labeled "Microwave Safe". Some plastic containers soften, as the food inside gets hot. "Boiling bags" and tightly closed plastic bags should be slit, pierced or vented as directed by package.</p> 
 <p data-bbox="150 639 266 662">Plastic wrap</p>	<p data-bbox="353 555 901 639">Microwave-safe only. Use to cover food during cooking to retain moisture. Do not allow plastic wrap to touch food.</p> 
 <p data-bbox="135 804 281 826">Thermometers</p>	<p data-bbox="353 751 891 774">Microwave-safe only (meat and candy thermometers).</p> 
 <p data-bbox="156 963 260 986">Wax paper</p>	<p data-bbox="353 900 823 952">Use as a cover to prevent splattering and retain moisture.</p> 

MATERIALS CAN NOT BE USED IN MICROWAVE OVEN

UTENSILS	REMARKS
 <p>Aluminum tray</p>	May cause arcing. Transfer food into microwave-safe dish. 
 <p>Food carton with metal handle</p>	May cause arcing. Transfer food into microwave-safe dish. 
 <p>Metal or metal trimmed utensils</p>	Metal shields the food from microwave energy. Metal trim may cause arcing. 
 <p>Metal twist ties</p>	May cause arcing and could cause a fire in the oven. 
 <p>Paper bags</p>	May cause a fire in the oven. 
 <p>Plastic foam</p>	Plastic foam may melt or contaminate the liquid inside when exposed to high temperature. 
 <p>Wood</p>	Wood will dry out when used in the microwave oven and may split or crack. 

PRODUCT SETTING

NAMES OF MICROWAVE OVEN PARTS AND ACCESSORIES

Remove the oven and all materials from the carton and oven cavity.



Turntable Ring Assembly

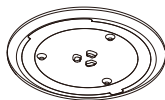

Glass Turntable

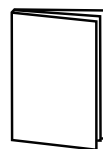

Instruction Manual

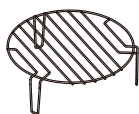

Higher Bake Rack
(Can not be used in microwave function and must be placed on the glass tray.)



Lower Bake Rack
(Can not be used in microwave function and must be placed on the glass tray.)

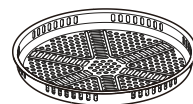

Bake Tray (Cannot be used in conjunction with microwave function and can be placed on the bake rack.)

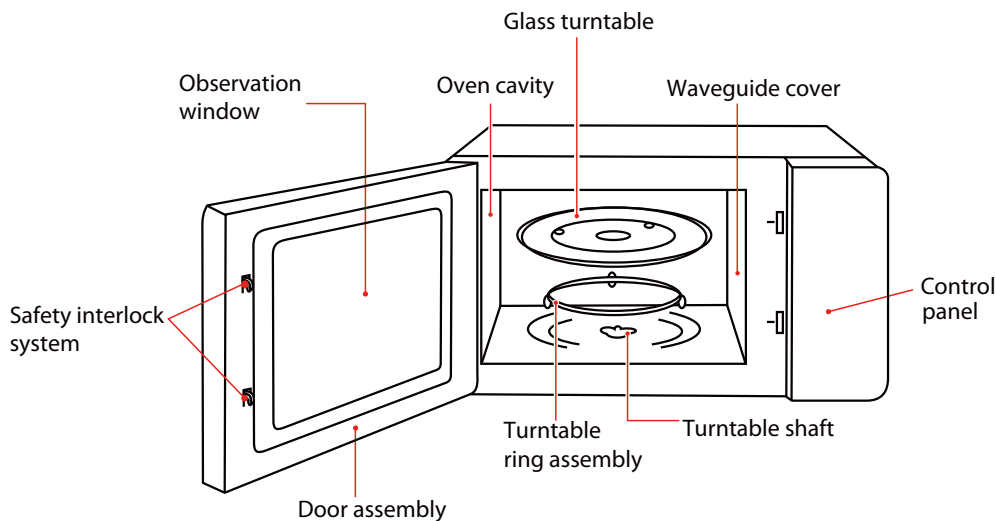

NOTE

In case of any differences between the appliance and the pictures in this manual, the product shall prevail.

TURNTABLE INSTALLATION

Cleaning the cooking compartment and putting the turntable in place.

For new installations, make sure all packaging and shipping tape has been removed from the turntable shaft.

Before using the appliance to prepare food for the first time, you will need to put the turntable in place correctly. You must clean the cooking compartment and accessories.

How to put the turntable in place:

1. Place the turntable ring assembly^③ into the recess in the cooking compartment.
2. Place the glass turntable^① on the turntable ring assembly^③. Fit the raised, curved lines in the center of the glass turntable bottom between the three spokes of the shaft.

Make sure that the glass turntable^① engages in the turntable shaft^② in the center of the cooking compartment floor. The rollers on the shaft should fit inside the turntable bottom ridge.

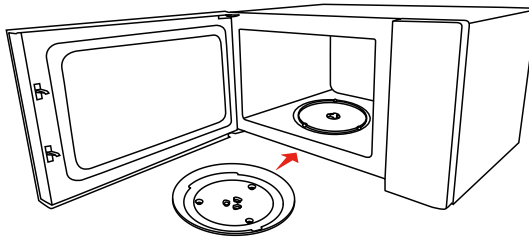
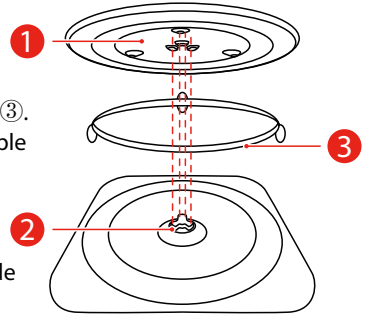

NOTE

- Never use the appliance without the turntable. Make sure that it is properly engaged. The turntable can turn clockwise or anti-clockwise.
- Never place the glass turntable upside down. The glass turntable should never be restricted.
- Both glass turntable and turntable ring assembly must always be used during cooking.
- All food and containers of food are always placed on the glass turntable for cooking.
- Never restrict the movement of the turntable.
- If glass turntable or turntable ring assembly cracks or breaks, contact your nearest authorized service center.

COUNTERTOP INSTALLATION

Remove all packing material and accessories. Examine the oven for any damage such as dents or broken door. Do not install if oven is damaged.

Cabinet: Remove any protective film found on the microwave oven cabinet surface. Do not remove the waveguide cover that is attached to the oven cavity to protect the magnetron.

INSTALLATION

1. Select a level surface that provide enough open space for the intake and/or outlet vents.
 - a. The minimum installation height is 85cm.
 - b. The rear surface of appliance shall be placed against a wall. Leave a minimum clearance of 30cm above the oven. A minimum clearance of 20cm is required between the oven and any adjacent walls.
 - c. Do not remove the legs from the bottom of the oven.
 - d. Blocking the intake and/or outlet openings can damage the oven.
 - e. Place the oven as far away from radios and TV as possible. Operation of microwave oven may cause interference to your radio or TV reception.

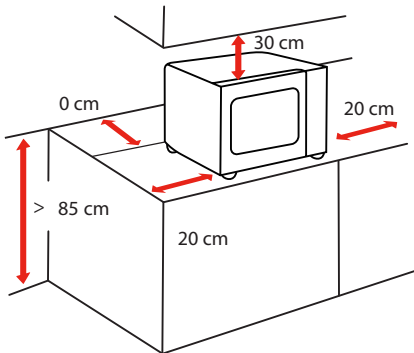

SIDE	DISTANCE CM
Top	30cm
Left	20cm
Right	20cm
Behind	0cm
Front	Open

2. Plug microwave oven into a standard household outlet. Be sure the voltage and the frequency is the same as the voltage and the frequency on the rating label.



NOTE

- Do not install oven over a range cooktop or other heat-producing appliance. If installed near or over a heat source, the oven could be damaged and the warranty would be void.

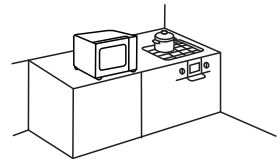

The accessible surface may be hot during operation

INSTRUCTION FOR USE

BEFORE USING FOR THE FIRST TIME

It is normal that the oven may produce unpleasant odors when it is used for the first time.

This section tells you what you need to do before using your microwave to prepare food for the first time. Read the section entitled "**PRODUCT SAFETY**" beforehand.

Before you can use your new appliance, you will need to put the turntable in place correctly. You must also clean the cooking compartment and accessories.



NOTE

- Never use the appliance without the turntable.
- Make sure that it is properly engaged. The turntable can turn clockwise or anti-clockwise.

OPERATION

CONTROL PANEL AND FEATURES

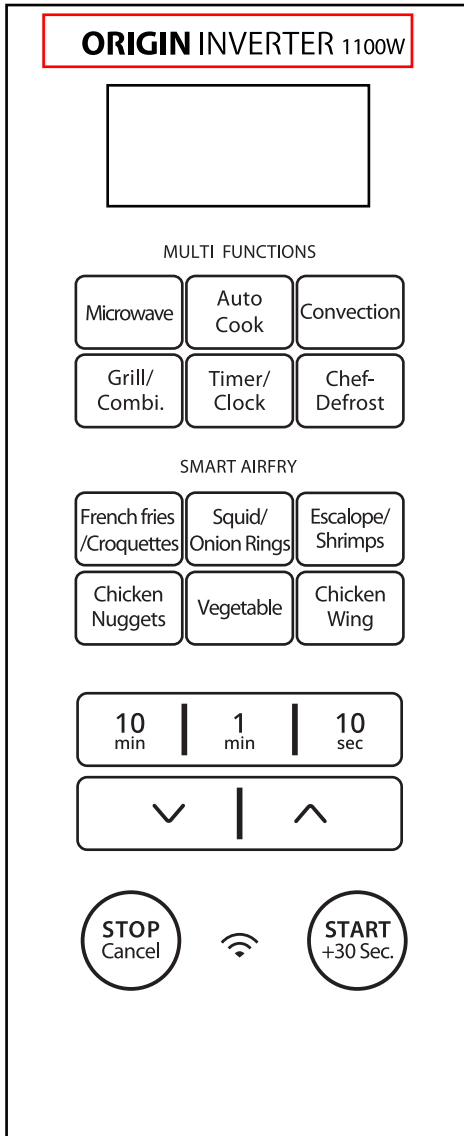

(You can also control the oven by app control.)



- App control: Download the TSmartLife first, then connect the app to your oven by the insert of TSmartLife APP connection guide.

1. STANDBY MODE

- a When the microwave oven is plugged into an outlet, "00:00" will display, and the oven will enter the standby mode.
- b During the setting, if **STOP** Cancel is pressed or if there is no operation within 1 minute, the setting is invalid. And then the oven will enter the standby mode.
- c In the paused state of cooking, if **STOP** Cancel is pressed or there is no operation within 10 minutes, the oven will return to the standby mode.

2. SETTING THE CLOCK

- a Press **Timer/** Clock twice, "00:00" will display.



- b Press  or  to set the hour figures.



- c Press **START** +30 Sec. to confirm.



- d Press  or  to set the minute figures.



- e Press **START** +30 Sec. to confirm.



NOTE

- To reset the clock, please repeat step a to step e.
- The clock is a 24-hour display.

3. SETTING THE KITCHEN TIMER

- a Press **Timer/Clock** once, "00:00" will display.

Timer/
Clock

- b Press **10 min**, **1 min**, **10 sec**, **∨**, or **∧** to enter the desired time.
The maximum time value is "99:50".

10 min 1 min 10 sec

Or



- c Press **START +30 Sec.** to start counting down.

START
+30 Sec.



NOTE

• The kitchen timer is a timer.

4. MICROWAVE COOKING

10 power levels are available

POWER	100%	90%	80%	70%	60%	50%	40%	30%	20%	10%
DISPLAY	PL10	PL09	PL08	PL07	PL06	PL05	PL04	PL03	PL02	PL01

- a Press **Microwave** once, "PL10" will display.

Microwave

- b Press **Microwave** repeatedly, or press **∨** or **∧** to set the power level. The 10 power levels are available.

Microwave

Or



- c Press **START +30 Sec.** to confirm.

START
+30 Sec.

- d Press **10 min**, **1 min**, **10 sec**, **∨**, or **∧** to set the cooking time.
The maximum time value is "99:50".

10 min 1 min 10 sec

Or



- e Press **START +30 Sec.** to start cooking.

START
+30 Sec.

App Control:



• To ensure safety, the APP remote control function is not allowed.

- 1 Tap the microwave icon to enter the cooking function setting page.

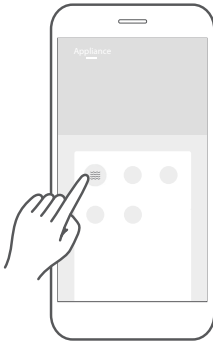

- 2 Swipe up and down to set the power level.

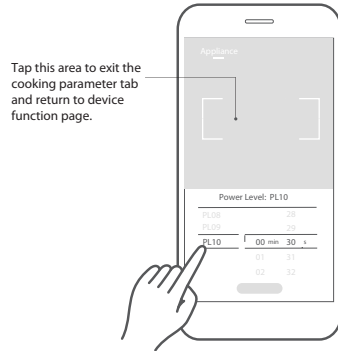

- 3 Swipe up and down to set the cooking time.

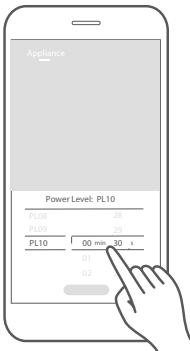

- 4 Tap "Start" to confirm. Then press "START +30 Sec." on the appliance to start cooking.

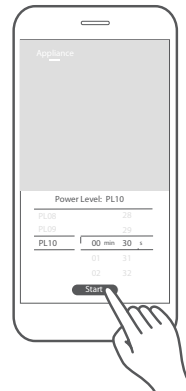

• Do not swipe too fast when sliding the wheel up and down to select parameters. Tap the "Start" button when the numbers stop scrolling.

5. GRILL COOKING

a Press **Grill/Combi.** once, "G-1" will display.

Grill/
Combi.

b Press **START +30 Sec.** confirm.

START
+30 Sec.

c Press **10 min**, **1 min**, **10 sec**, **∨**, or **∧** to set the cooking time. The maximum time value is "99:50".

10 min **1 min** **10 sec**

Or



d Press **START +30 Sec.** to start cooking.

START
+30 Sec.



NOTE

- The buzzer will sound to remind you to turn the food over during grilling cooking. If no operation, the oven will continue working.

App Control:



NOTE

- To ensure safety, the APP remote control function is not allowed.

1 Tap the grill icon  to enter the cooking function setting page.

2 Swipe up and down to set the cooking time.

3 Tap "Start" to confirm. Then press " **START +30 Sec.** " on the appliance to start cooking.

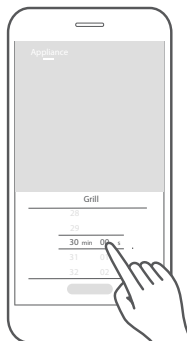
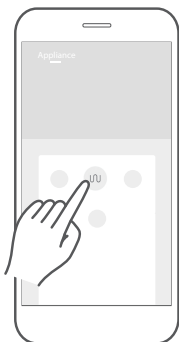

NOTE

- Do not swipe too fast when sliding the wheel up and down to select parameters. Tap the "Start" button when the numbers stop scrolling.

6. COMBINATION COOKING

a Press **Grill/Combi.** twice and then "C-1".

Grill/Combi.

b Press **Grill/Combi.** repeatedly to set the cooking mode. "C-1, C-2, C-3, C-4" are available.

Grill/Combi.

c Press **START +30 Sec.** to confirm.

START +30 Sec.

d Press **10 min**, **1 min**, **10 sec**, **∨**, or **∧** to set the cooking time. The maximum time value is "99:50".

10 min **1 min** **10 sec**

Or



e Press **START +30 Sec.** to start cooking.

START +30 Sec.

Function	Display	Microwave	Grill	Convection
Combi. 1	C-1	●		●
Combi. 2	C-2	●	●	
Combi. 3	C-3		●	●
Combi. 4	C-4	●	●	●

App Control:



• To ensure safety, the APP remote control function is not allowed.

For example, set "C-1":

1 Tap the "C-1" icon  to enter the cooking function setting page.

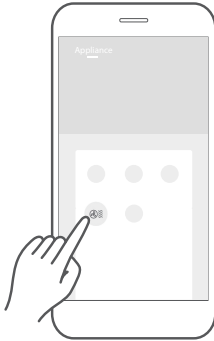

2 Swipe up and down to set the cooking time.

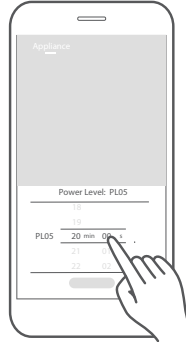

3 Tap "Start" to confirm. Then press " **START** +30 Sec." on the appliance to start cooking.

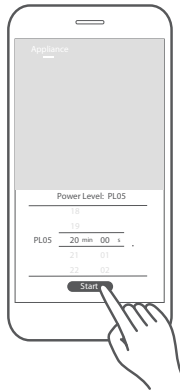

• Do not swipe too fast when sliding the wheel up and down to select parameters. Tap the "Start" button when the numbers stop scrolling.

7. DEFROST BY TIME

a Press **Chef-Defrost** once, "dEF1" will display.

Chef-Defrost

b Press **START +30 Sec.** to confirm.

START +30 Sec.

c Press **10 min**, **1 min**, **10 sec**, **∨**, or **∧** to set the desired defrosting time. The maximum time value is "99:50".

10 min 1 min 10 sec

Or



d Press **START +30 Sec.** to start defrosting.

START +30 Sec.



NOTE

- The default power level is PL03 and it cannot be changed.
- The buzzer will sound to remind you to turn the food over during defrosting. If no operation, the oven will continue working.

App Control:



NOTE

- To ensure safety, the APP remote control function is not allowed.

- 1 Tap the time defrost icon  to enter the cooking function setting page.
- 2 Swipe up and down to set the cooking time.
- 3 Tap "Start" to confirm. Then press "START +30 Sec." on the appliance to start defrosting.

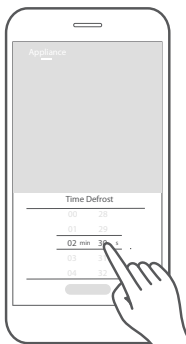
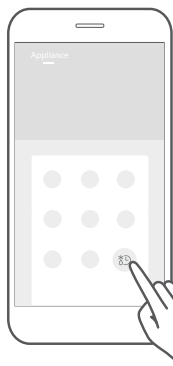

NOTE

- Do not swipe too fast when sliding the wheel up and down to select parameters. Tap the "Start" button when the numbers stop scrolling.

8. DEFROST BY WEIGHT

a Press **Chef-Defrost** twice, "dEF2" will display

Chef-Defrost

b Press **START +30 Sec.** to confirm.

START +30 Sec.

c Press **∨** or **∧** to set the weight of the food. The range of weight is 100-2000g.



d Press **START +30 Sec.** to start defrosting.

START +30 Sec.



NOTE

- The buzzer will sound to remind you to turn the food over during defrosting. If no operation, the oven will continue working.

App Control:



NOTE

- To ensure safety, the APP remote control function is not allowed.

- 1 Tap the weight defrost icon  to enter the cooking function setting page.
- 2 Swipe up and down to set the weight of the food.
- 3 Tap "Start" to confirm. Then press " **START +30 Sec.** " on the appliance to start defrosting.

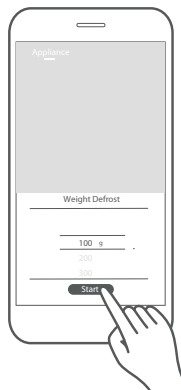
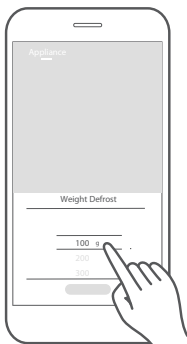
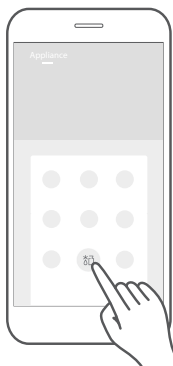



NOTE

- Do not swipe too fast when sliding the wheel up and down to select parameters. Tap the "Start" button when the numbers stop scrolling.

9. CONVECTION COOKING WITH PREHEAT FUNCTION

- a Press **Convection** once and then "150°C".

Convection

- b Press **Convection** repeatedly or press  or  to set the temperature. The 10 options are available, including 40°C, 70°C, 150°C, 160°C, 170°C, 180°C, 200°C, 210°C, 220°C, 230°C.

Convection



Or



- c Press **START +30 Sec.** to start preheating.

START
+30 Sec.

- d When preheating is completed, the oven will beep. Open the door and place the food in the oven. Then close the oven door.

- e Press **10 min**, **1 min**, **10 sec**, , or  to set the cooking time. The maximum time value is "99:50".

10 min 1 min 10 sec

Or



- f Press **START +30 Sec.** to start cooking.

START
+30 Sec.

10. CONVECTION COOKING WITHOUT PREHEAT FUNCTION

a Press **Convection** once and then "150°C".

Convection

b Press **Convection** repeatedly or press ∇ or \blacktriangle to set the temperature. The 10 options are available, including 40°C, 70°C, 150°C, 160°C, 170°C, 180°C, 200°C, 210°C, 220°C, 230°C.

Convection

Or



c Press $\overset{10}{\text{min}}$, $\overset{1}{\text{min}}$, or $\overset{10}{\text{sec}}$ once to enter the cooking time setting.

$\overset{10}{\text{min}}$ $\overset{1}{\text{min}}$ $\overset{10}{\text{sec}}$

d Press $\overset{10}{\text{min}}$, $\overset{1}{\text{min}}$, $\overset{10}{\text{sec}}$, ∇ , or \blacktriangle to set the cooking time. The maximum time value is "99:50".

$\overset{10}{\text{min}}$ $\overset{1}{\text{min}}$ $\overset{10}{\text{sec}}$

Or



e Press **START +30 Sec.** to start cooking.

START
+30 Sec.

App Control:



- To ensure safety, the APP remote control function is not allowed.

- 1 Tap the convention icon  to enter the cooking function setting page.

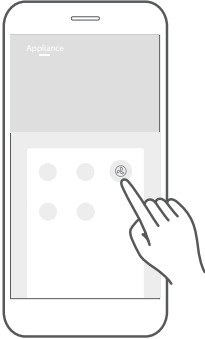

- 2 Swipe up and down to set the temperature.

Tap this area to exit the cooking parameter tab and return to device function page.

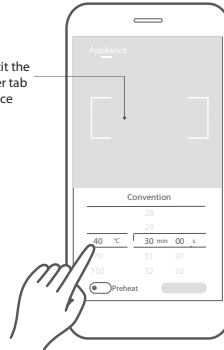

- 3 Swipe up and down to set the cooking time.

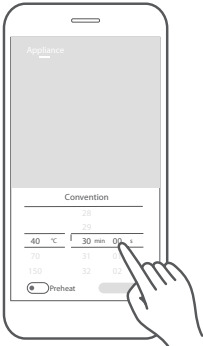

- 4 Tap the  icon to choose the preheating on/off.

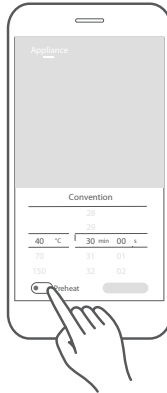

- 5 Tap "Start" to confirm. Then press "**START** +30 Sec." on the appliance to start cooking.

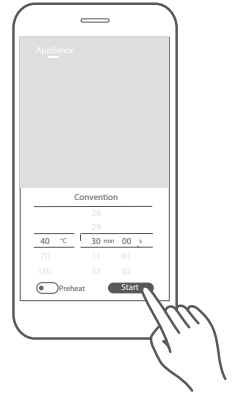

- Do not swipe too fast when sliding the wheel up and down to select parameters. Tap the "Start" button when the numbers stop scrolling.

11. MULTI-STAGE COOKING

Example: Defrost food for 500g and then cook with 80% microwave power for 7 minutes.

a Press **Chef-Defrost** twice, "dEF2" will display

Chef-Defrost

b Press **START +30 Sec.** confirm.

START +30 Sec.

c Press **∨** or **∧** to set the weight of the food to 500g.

∨ ∧

d Press **Microwave** once, "PL10" will display.

Microwave

e Press **Microwave** repeatedly, or press **∨** or **∧** to set the power level to PL08.

Microwave

Or

∨ ∧

f Press **START +30 Sec.** to confirm.

START +30 Sec.

g Press **10 min**, **1 min**, **10 sec**, **∨**, or **∧** to set the cooking time to 7 minutes.

10 min 1 min 10 sec

Or

∨ ∧

h Press **START +30 Sec.** to start cooking.

START +30 Sec.



NOTE

- Two cooking stages can be set in multi-stage cooking.
- If you set the defrost function, it will work in the first stage.
- The speedy cooking, sensor menu, auto menu, preheating, and kitchen timer can't be set as one of the multi-stage.

12. SPEEDY COOKING

- a In standby mode, press **START +30 Sec.** to cook food at 100% power level for 30 seconds. Each press on the same key can increase 30 seconds and the maximum time value is "99:50".



- b In standby mode, press $\frac{10}{\text{min}}$, $\frac{1}{\text{min}}$, or $\frac{10}{\text{sec}}$ to set a cooking time at 100% power. Then press **START +30 Sec.** to start cooking.



NOTE

- In the cooking state, each more press on **START +30 Sec.**, $\frac{10}{\text{min}}$, $\frac{1}{\text{min}}$, or $\frac{10}{\text{sec}}$ can increase the corresponding cooking time.
And press ∇ or \blacktriangle can change the cooking time.
(Except the defrosting by weight, preheating, sensor menu, and auto menu.)

13. AUTO MENU

- a Press **Auto Cook** once and then "01".



- b Press **Auto Cook** repeatedly or press ∇ or \blacktriangle to choose the auto menu.
The 10 auto menus are available.



Or

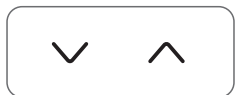

- c Press **START +30 Sec.** to confirm.



- d Press ∇ or \blacktriangle to set the weight of the food.



- e Press **START +30 Sec.** to start cooking.



Auto menu chart

Menu	Weight	Display	Power
01 Pizza	200g	200g	Conv.200°C
	400g	400g	
02 Potato	200g	200g	PL10
	400g	400g	
	600g	600g	
03 Meat	250g	250g	PL08
	350g	350g	
	450g	450g	
04 Fish	250g	250g	PL08
	350g	350g	
	450g	450g	
05 Vegetable	200g	200g	PL08
	300g	300g	
	400g	400g	
06 Beverage	1cup	1	PL10
	2cups	2	
	3cups	3	
07 Pasta	50g	50g	PL08
	100g	100g	
	150g	150g	
08 Popcorn	50g	50g	PL10
	100g	100g	
09 Cake	475g	475g	Conv.170°C
10 Chicken	500g	500g	Conv.230°C
	750g	750g	
	1000g	1000g	
	1200g	1200g	



NOTE

• For the menu "09 Cake", please skip the step d.

App Control:



NOTE

- To ensure safety, the APP remote control function is not allowed.

- 1 Tap the menu icon to enter the auto menu function setting page. And then you can tap "Recipe" to open the related recipe.

Tap this area to exit the cooking parameter tab and return to device function page.

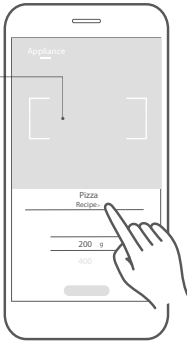

- 2 Swipe up and down to set the weight of the food.

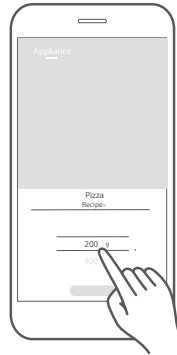

- 3 Tap "Start" to confirm. Then press " **START** +30 Sec." on the appliance to start cooking.



NOTE

- Do not swipe too fast when sliding the wheel up and down to select parameters. Tap the "Start" button when the numbers stop scrolling.

14. AIRFRY MENU

For the menus “ French fries /Croquettes ”, “ Squid/ Onion Rings ”, “ Escalope/ Shrimps ”:

- a** In standby mode, press the corresponding menu key

once or twice to choose the menu.

Example: Press French fries /Croquettes twice to choose the croquettes.

French fries /Croquettes Squid/ Onion Rings Escalope/ Shrimps

- b** Press **START** +30 Sec. to confirm.

START
+30 Sec.

- c** Press **START** +30 Sec. to start cooking.

START
+30 Sec.

For the menus “ Chicken Nuggets ”, “ Vegetable ”, “ Chicken Wing ”:

- a** In standby mode, press the corresponding menu key once.

Chicken Nuggets Vegetable Chicken Wing

- b** Press **START** +30 Sec. to confirm.

START
+30 Sec.

Airfry menu chart

Menu key	The times of pressing the menu key	Menu	Weight	Power
French fries /Croquettes	Once	Frozen French Fries	300g	C-4
	Twice	Croquettes	400g	Conv. 230°C
Squid/ Onion Rings	Once	Squid	280g	Conv. 230°C
	Twice	Onion Rings	280g	Conv. 230°C
Escalope/ Shrimps	Once	Escalope	400g	Conv. 230°C
	Twice	Shrimps	250g	Conv. 230°C
Chicken Nuggets	Once	Chicken Nuggets	340g	Conv. 230°C
Vegetable	Once	Vegetable	200g	Conv. 230°C
Chicken Wing	Once	Chicken Wing	500g	Conv. 230°C



NOTE

- For the menus “croquettes, squid, onion rings, escalope, shrimps, chicken nuggets, chicken wing”, the buzzer will sound to remind you to turn the food over during cooking. If no operation, the oven will continue working.

App Control:



NOTE

- To ensure safety, the APP remote control function is not allowed.

- 1 Tap the menu icon to enter the auto menu function setting page. And then you can tap "Recipe" to open the related recipe.

Tap this area to exit the cooking parameter tab and return to device function page.

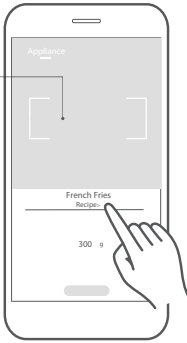

- 2 Tap "Start" to confirm. Then press " **START** +30 Sec. " on the appliance to start cooking.

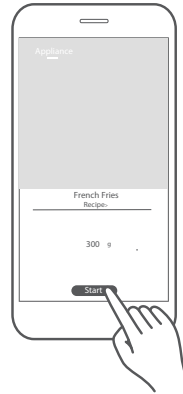

NOTE

- Do not swipe too fast when sliding the wheel up and down to select parameters. Tap the "Start" button when the numbers stop scrolling.

15. INQUIRING FUNCTION

- a If the clock has been set, the current time will display for three seconds by pressing  in the cooking state.

Timer/
Clock

- b In the microwave cooking state, press  to inquire about the power level. It will display for three seconds. In grilling, combination, and convection cooking state, the inquiring way can be done by pressing the corresponding key.

Microwave



16. ECO FUNCTION

- a To enter ECO mode:
In standby mode, and the oven door is closed, press  once. The screen will turn off.

STOP
Cancel

- b To cancel ECO mode:
In ECO mode, pressing any key, or opening the door will cancel it.

17. WIRELESS CONNECTION

- a Connect the network
Press and hold "  " for 3 seconds, "AP" and flashing "  " show on display. If it fails, "N0~N5" will display, and the oven will return to standby mode after 30 seconds.



- b Disconnect from the network
Press and hold "  " for 8 seconds, "--" flashes for few seconds, if the link has been removed successfully, the screen will display "8888" and then return to standby mode after 3 seconds. If it fails, "FFFF" will display, and the oven will return to standby mode after 3 seconds.



App Control:



NOTE

- To ensure safety, the APP remote control function is not allowed.

RECIPES

The Recipes page displays cloud recipes, and cooking parameters have been verified by professional chefs. The recipe page is continuously being updated to provide more cooking variety.

- 1 Tap the recipe picture to enter the recipe details page.

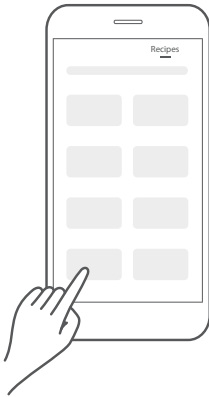

- 2 Swipe up and down to view the required ingredients and detailed cooking steps. Tap "Cook Now" to confirm. Then press " **START** " +30 Sec. " on the appliance to start cooking.

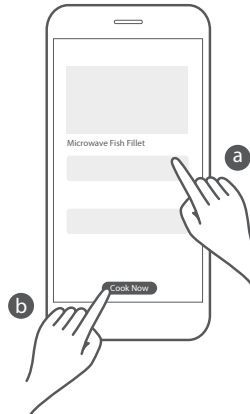

FAQ

1 Q: Does the home appliance support 5G wireless routers?

A: This product does not support wireless routers in the 5G frequency band. Please ensure that the mobile phone is connected to the 2.4G wireless network before networking the home appliance.

2 Q: Why do I need to turn on the Bluetooth of my mobile phone before networking?

A: Turning on the Bluetooth of the mobile phone can improve the success rate of networking and avoid the failure of the home appliance networking.

3 Q: How many family members are allowed to use the APP at most for the same appliance?

A:

- 1) A home appliance only allows one account to be associated. If a new account is used to bind this home appliance, the previous account will be forced to disassociate and can't be used.
- 2) You can use the sharing function in the APP to grant permissions to use the home appliance to the users who need it, enter My Setup-My devices, select the device to be shared, and tap the button at the bottom of the APP to add the sharing user
- 3) There is no limit to the number of sharing users. The users shared to have all the operating permissions of the home appliance. Please use this function with caution
- 4) After the sharing user deletes the home appliance, the home appliance of the user shared is automatically deleted from the APP. If the user shares to delete the home appliance, it is only deleted from its account, without affecting other users.

4 Q: Why the product can't be searched by model in the APP?

A:

- 1) Check whether the region on the APP setting page is the same as the purchase region. If the address information is incorrect, the model can't be displayed.
- 2) If the area of the APP setting page is correct, contact the after-sales service or ask for assistance through the help portal on the APP.

CLEANING AND MAINTENANCE

CLEANING

With good care and cleaning, your appliance will retain its appearance and remain fully functioning for a long time to come. We will explain here how you should correctly care for and clean your appliance.



WARNING

- Scratched glass in the appliance door may develop into a crack. Do not use a glass scraper, sharp or abrasive cleaning aids or detergents.
- The surface of the appliance may become damaged if it is not cleaned properly. Microwave energy may escape. Clean the appliance on a regular basis, and remove any food remnants immediately.
- Do not immerse the appliance in water or clean under a jet of water.

Cleaning agent

To ensure that the different surfaces are not damaged by using the wrong cleaning agent, observe the information in the table. Wash new sponge cloths thoroughly before use.

Do not use:



Harsh or abrasive cleaning agents



Metal or glass scrapers to clean the door panels



Metal or glass scrapers to clean the door seal



Hard scouring pads or sponges



Cleaning agents with a high alcohol content

APPLIANCE FRONT

Hot soapy water:

Clean using a dish cloth and then dry with a soft cloth. Do not use metal or glass scrapers for cleaning.

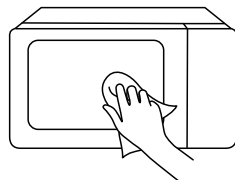

APPLIANCE FRONT WITH STAINLESS STEEL

Hot soapy water:

Clean using a dish cloth and then dry with a soft cloth. Remove splashes and patches of limescale, grease, starch and albumin immediately. Corrosion can form under these patches or splashes. Do not use glass cleaners or metal or glass scrapers for cleaning.

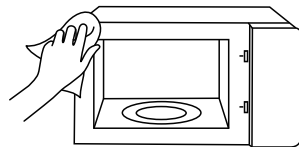

COOKING COMPARTMENT MADE OF STAINLESS STEEL

Hot soapy water or vinegar solution:

Clean using a dish cloth and then dry with a soft cloth. Do not use oven spray or any other aggressive oven cleaners or abrasive materials. Scouring pads, rough sponges and pan cleaners are also unsuitable. These items scratch the surface. Allow the interior surfaces to dry completely.

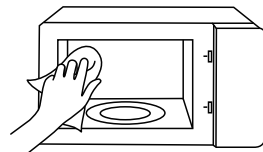

RECESS IN THE COOKING COMPARTMENT

Damp cloth:

Water must not be allowed to run into the appliance through the turntable drive. Dry the turntable drive with a cloth.

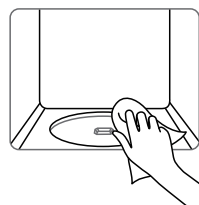

TURNTABLE AND ROLLER RING

Hot soapy water:

When placing the turntable back into its recess, it must engage properly.

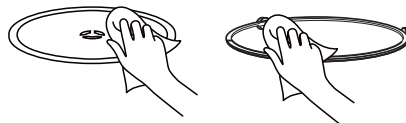

DOOR PANELS

Glass cleaner:

Clean with a dish cloth. Do not use glass scrapers.

TROUBLE SHOOTING

Normal

Microwave oven interfering TV reception	Radio and TV reception may be interfered when microwave oven operating. It is similar to the interference of small electrical appliances, like mixer, vacuum cleaner, and electric fan. It is normal.
Dim oven light	In low power microwave cooking, oven light may become dim. It is normal.
Steam accumulating on door, hot air out of vents	In cooking, steam may come out of food. Most will get out from vents. But some may accumulate on cool place like oven door. It is normal.
Oven started accidentally with no food in.	It is forbidden to run the unit without any food inside. It is very dangerous.

Trouble	Possible Cause	Remedy
Oven cannot be started.	(1) Power cord is not plugged in tightly.	Unplug. Then plug again after 10 seconds.
	(2) Fuse blowing or circuit breaker works.	Replace fuse or reset circuit breaker (repaired by professional personnel of our company)
	(3) Trouble with outlet.	Test outlet with other electrical appliances.
Oven does not heat.	(4) Door is not closed well.	Close door well.

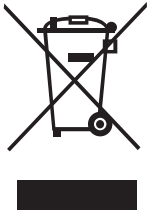

According to Waste of Electrical and Electronic Equipment (WEEE) directive, WEEE should be separately collected and treated. If at any time in future you need to dispose of this product please do NOT dispose of this product with household waste. Please send this product to WEEE collecting points where available.

#DetailsMatter