

TOSHIBA

DUAL DRUM WASHER DRYER

OWNER'S MANUAL

MODEL:

TWD-BL160D4 Series

Read this manual

Use all instructions and explanations of
The installation before use. Follow the
Instructions carefully. Keep the operation
Instructions handy for later use. If the
Application is sold or passed on then ensure
That the new owner always receives those
Operation instructions.



CAUTION: HOT SURFACE !



CAUTION: RISK OF FIRE !



CAUTION: READ THE INSTRUCTIONS!

CONTENTS

SAFETY INSTRUCTIONS

■ Safety Instructions	2
-----------------------------	---

INSTALLATION

■ Product Description	10
■ Installation	12

OPERATIONS

■ Quick Start	16
■ Before Each Washing	17
■ Detergent Dispenser	18
■ Control Panel	19
■ Option.....	20
■ Setting guide.....	23
■ Programmes.....	26
■ Washing Programmes Table	28

MAINTENANCES

■ Cleaning And Care	31
■ Trouble Shooting	34
■ Technical Specifications	35

SAFETY INSTRUCTIONS

■ Safety Instructions

- This appliance is not intended for use by persons (including children) with reduced physical, sensory or mental capabilities or lack of experience and knowledge unless they have been given supervision or instruction concerning use of the appliance by a person responsible for their safety.
- Children should be supervised to ensure that they do not play with the appliance.
- If the supply cord is damaged, it must be replaced by the manufacturer, its service agent or similarly qualified persons in order to avoid a hazard.
- The new hose-sets supplied with the appliance are to be used and that old hose-sets should not be reused.
- The openings must not be obstructed by a carpet.
- This appliance is intended to be used in household and similar applications such as:
 - staff kitchen areas in shops, offices and other working environments;
 - farm houses;
 - by clients in hotels, motels and other residential type environments;
 - bed and breakfast type environments;
 - areas for communal use in blocks of flats or in launderettes.
- The maximum permissible inlet water pressure, 1 MPa, for appliances intended to be connected to the water mains. The minimum permissible inlet water pressure, 0.05 MPa, if this is necessary for the correct operation of the appliance.

SAFETY INSTRUCTIONS

■ Safety Instructions

For your safety, the information in this manual must be followed to minimize the risk of fire or explosion, electric shock, or to prevent property damage, personal injury or loss of life.

Explanation of the symbols:

Warning!

This combination of symbol and signal word indicates a potentially dangerous situation which may result in death or serious injuries unless it's avoided.

Caution!

This combination of symbol and signal word indicates a potentially dangerous situation which may result in slight or minor injuries or damage to property and the environment.

Note!

This combination of symbol and signal word indicates a potentially dangerous situation which may result in slight or minor injuries.

Warning!

The electric shock!

- If the supply cord is damaged, it must be replaced by the manufacturer, its service agent or similarly qualified persons in order to avoid a hazard.

SAFETY INSTRUCTIONS

- The new hose-sets supplied with the appliance must be used and the old hose-sets must not be used.
- Before maintenance, unplug the appliance.
- Always unplug the machine and turn off the water supply after use. The standard inlet water pressure: 0.05MPa~1MPa.
- This appliance must be grounded. In the event of malfunction or breakdown , grounding will reduce the risk of electric shock by providing a path of least resistance for electric current.
- This appliance is equipped with a cord having an equipment-grounding conductor and grounding plug. The plug must be plugged into an appropriate outlet that is properly installed and grounded in accordance with all local codes and ordinances.
- Improper connection for the appliance when using not grounded outlet or when GND terminal of outlet is not suitable with GND terminal of power plug, can result in risk of electric shock.. Check with a qualified electrician or service person if you are in doubt as to whether the appliance is properly grounded.
- Do not modify the plug provided with the appliance. If it does not fit the outlet , have a proper outlet installed by a qualified electrician.
- Make sure that the water and electrical devices must be connected by a qualified technician in accordance with the manufacturer's instructions and local safety regulations.

SAFETY INSTRUCTIONS

- Pull out its plug from the power socket before cleaning or maintenance.
- Do not use any socket with rated current less than that of appliance. Never pull out power plug with wet hand.
- Please remember to disconnect water and power supply immediately after the clothes are washed.

Risk to children!

- The appliance can be used by children aged from 8 years and above and persons with reduced physical, sensory or mental capabilities or lack of experience and knowledge if they have been given supervision or instruction concerning use of the appliance in a safe way and understand the hazards involved. Children shall not play with the appliance. Cleaning and user maintenance shall not be made by children without supervision.
- Children of less than 3 years should be supervised to ensure that they do not play with appliance.
- Animals and children may climb into the machine. Check the machine before every operation.
- Children should be supervised that they do not play with the appliance.
- Glass door may be very hot during the operation. Keep children and pets far away from the machine during the operation .
- Remove all packages and transport bolts before using the appliance. Otherwise, serious damage may result.
- Plug must be accessible after installation.

SAFETY INSTRUCTIONS

Risk of explosion!

- Do not wash or dry articles that have been cleaned in, washed in, soaked in, or spotted with combustible or explosive substances(such as wax, oil, paint, gasoline, degreasers, dry-cleaning solvents, kerosene, etc.) This may result in fire or explosion.
- The washer dryer is not to be used if industrial chemicals have been used for cleaning.
- The exhaust air must not be discharged into a flue which is for exhausting fumes from appliances burning gas or other fuels.
- Rinse the articles thoroughly by hand before putting them in the appliance.

Caution!

Installing the product!

- The appliance is for indoor use only.
- It isn't intended to be built-in using.
- The openings must not be obstructed by a carpet.
- The appliance shall not be installed in bath room or very wet rooms as well as in the rooms with explosive or explosive and corrosive gases.
- The appliance with single inlet valve only can be connected to the cold water supply.
- Plug must be accessible after installation.
- The appliance must not be installed behind a lockable door, a sliding door or a door with a hinge on the opposite side to that of the washer dryer.
- The appliance shall not be installed at a humid place.
- The household appliance isn't intended to be built-in.

SAFETY INSTRUCTIONS

- Remove all packages and transport bolts before using the appliance. Otherwise, serious damage may result.

Risk of damaging appliance!

- Your product is only for home use and is only designed for the textiles suitable for machine washing.
- Do not climb up and sit on top cover of the machine.
- Do not lean against machine door.
- Cautions during Handling Machine:
 - 1.Transport bolts shall be reinstalled to the machine by a specialized person.
 - 2.The accumulated water shall be drained out of the machine.
 - 3.Handle the machine carefully. Never hold each protruded part on the machine while lifting. Machine door can not be used as the handle during the conveyance.
 - 4.This appliance is heavy. Transport with care.
 - 5.That the hands shall not be inserted into running water extracting tub.
- Please do not close the door with excessive forces. If it is found difficult to close the door, please check if the clothes are put in or distributed well.
- It is forbidden to wash carpets.

Operating the appliance!

- Before washing the clothes at first time, the product shall be operated in one round of the whole procedures without the clothes inside.The suggested program is "DRUM CLEAN".
- Flammable and explosive or toxic solvents are forbidden. Gasoline and alcohol etc.Shall not be used as detergents. Please only select the detergents suitable for machine washing, especially for front load washing machine.

SAFETY INSTRUCTIONS

- Make sure that all pockets are emptied. Sharp and rigid items such as coin, brooch, nail, screw or stone etc. may cause serious damages to this machine.
- Please check whether the water inside the drum has been drained before opening its door. Please do not open the door if there is any water visible.
- Be careful of burning when the product drains hot washing water.
- Never refill the water by hand during washing.
- After the program is completed, Please wait for two minutes to open the door.
- If it is unavoidable that fabrics that contain vegetable or cooking oil or have been contaminated by hair care products. If they are placed in a tumble dryer they should first be washed in hot water with extra detergent, this will reduce, but not eliminate, the hazard.
- Adequate ventilation has to be provided to avoid the back flow of gases into the room from appliances burning other fuels, including open fires.
- Do not dry unwashed items in the appliance. Items that have been soiled with substances such as cooking oil, acetone, alcohol, petrol, kerosene, spot removers, turpentine, waxes and wax removers should be washed in hot water with an extra amount of detergent before being dried in the appliance.
- Items such as foam rubber (latex foam), shower caps, water proof textiles, rubber backed articles and clothes or pillows fitted with foam rubber pads should not be dried in the machine.

SAFETY INSTRUCTIONS

- Fabric softeners, or similar products, should be used as specified by the fabric softener instructions.
- The final part of a washer dryer cycle occurs without heat (cool down cycle) to ensure that the items are left at a temperature that ensures that the items will not be damaged.
- Remove all objects from pockets such as lighters and matches before use the appliance.
- Lint must not to be allowed to accumulate around the tumble dryer
- **WARNING:** Never stop a washer dryer before the end of the drying cycle unless all items are quickly removed and spread out so that the heat is dissipated.
- **WARNING:** The appliance must not be supplied through an external switching device, such as a timer, or connected to a circuit that is regularly switched on and off by a utility.

Packaging/Old appliance



This marking indicates that this product should not be disposed with other household wastes throughout the EU. To prevent possible harm to the environment or human health from uncontrolled waste disposal, recycle it responsibly to promote the sustainable reuse of material resources. To return your used device, please use the collection systems or contact the retailer where the product was purchased. They return and can take this product for environmental safe recycling.

INSTALLATION

■ Product Description

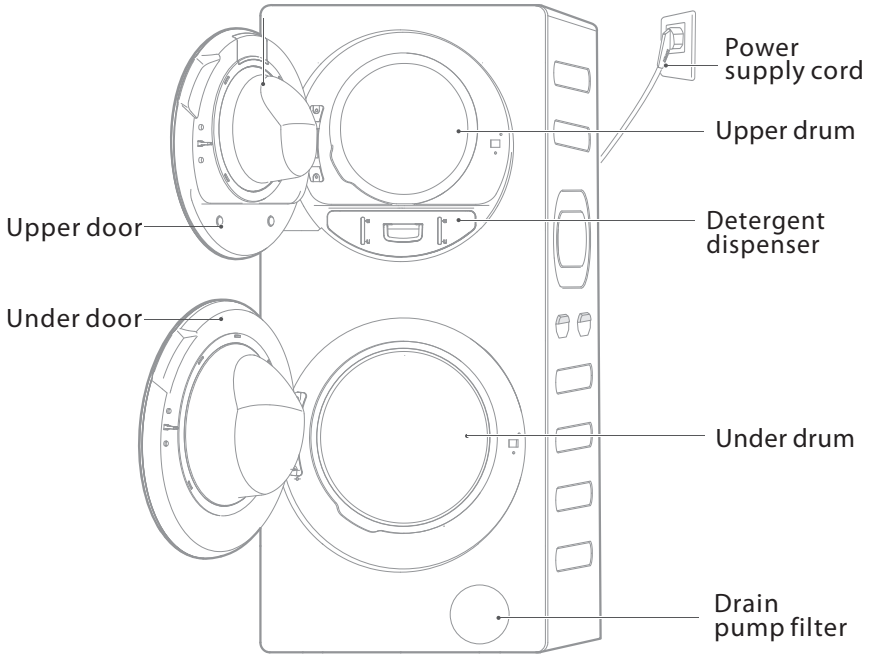

Note!

- The product line chart is for reference only, please refer to real product as standard.

Accessories

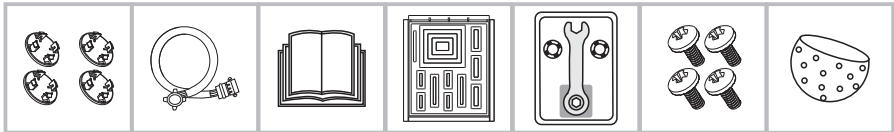

Transport hole plug
(9 plugs)

Supply hose cold water

Owner's manual

Rat resistance panel(optional)

Spanner assembly (optional)

Screw(optional)

Container

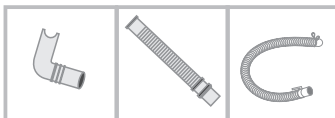

Drain hose connect

Extended drain hose

Drain hose

INSTALLATION

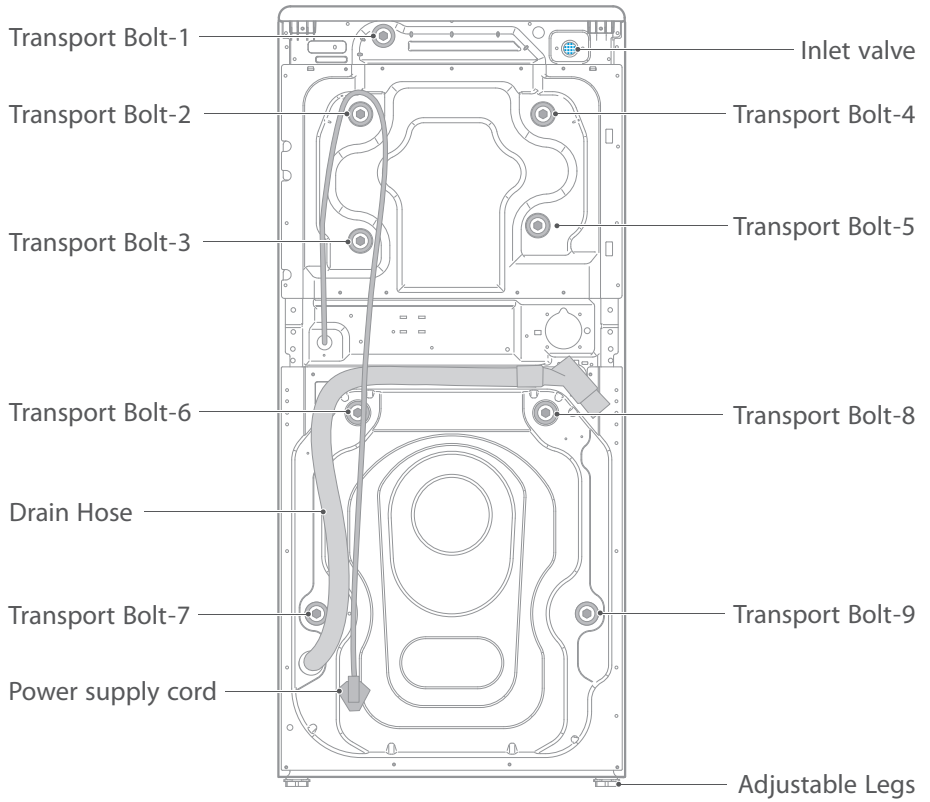

Note!

- The product line chart is for reference only, please refer to real product as standard.

INSTALLATION

■ Installation

Installation area

⚠ Warning!

- Stability is important to prevent the product from wandering!
- Make sure that the product should not stand on the power cord.

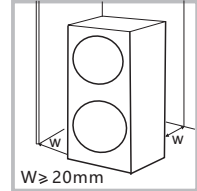

Before installing the machine, the location characterized as follows shall be selected:

- 1.Rigid, dry, and level surface
- 2.Avoid direct sunlight
- 3.Sufficient ventilation
- 4.Room temperature is above 0°C
- 5.Keep far away from the heat resources such as coal or gas.

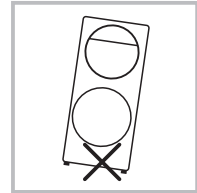

Install the rat resistance panel & Remove transport bolts

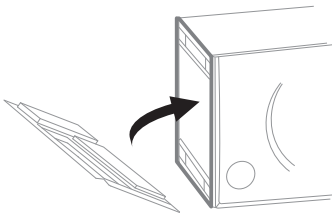

Screwed the rat resistance panel to the bottom of machine

Install the rat resistance panel

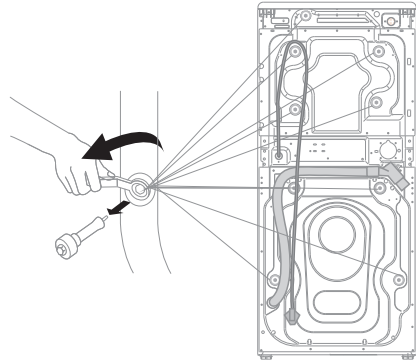

Remove transport bolts (9units)

Please take the following steps to remove the bolts:

- 1.Loosen 9 bolts with spanner and then remove them.
- 2.Cover the hole with transport hole plugs.
- 3.Keep the transport bolts properly for future use.

⚠ Warning!

- You must remove the transport bolts from the backside before using the product.
- You'll need the transport bolts again if you move the product, so make sure you keep them in a safe place.

INSTALLATION

Levelling the washing machine

⚠ Warning!

- Check with the gradienter if the machine placement is balanced and steady.
- If there is no gradienter, check the balance as per the following method.

1. Whether it's balanced from left to right

- Take a long stick, and tie a rope at the end of it. Bind a heavy object at the end of the rope.
- Hang the rope from the top cover of the machine. Adjust the legs till the difference between 'a' and 'b' is less than 1 cm.

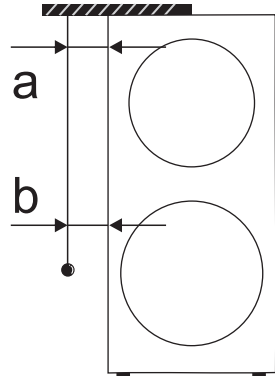

2. Whether it's balanced from front to back

- Put the stick at the middle of the Front cover, and hang the rope in front of the machine.
- Keep 13cm away from the rope end to the Front cover edge (c). Adjust the legs till 'd' is 5.5-6.5cm ('d' is the distance from rope to Under door).

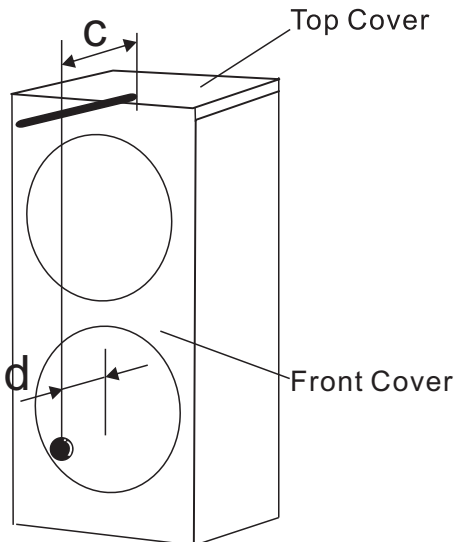

INSTALLATION

Levelling the washing machine

⚠ Warning!

- The lock nuts on all four feet must be screwed tightly against the housing.

1. Check if the legs are closely attached to the cabinet. If not, please turn them to their original positions tighten the nuts.
2. Loosen the lock nut turn the feet until it closely contacts with the floor.
3. Adjust the legs and lock them with a spanner, make sure the machine is steady.

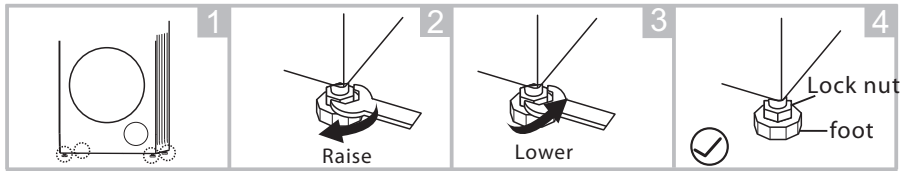

Connect Water Supply Hose

⚠ Warning!

- To prevent leakage or water damage, follow the instructions in this chapter!
- Do not kink, crush, modify or sever water inlet hose.

Connect the inlet pipe as indicated, There are two ways to connect the inlet pipe.

1. Connection between ordinary tap and inlet hose.

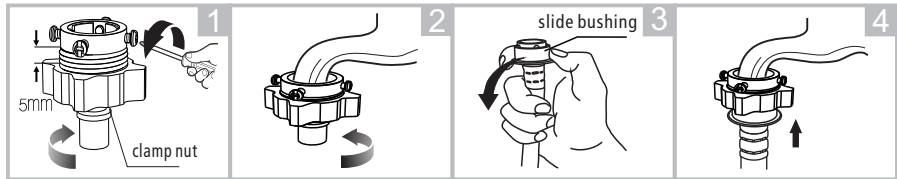

Loosen clamp nut and four bolts

Press the tap end tightly to the rubber ring inside the clamp, and then, tighten the 4 bolts

Press slide bushing, insert inlet hose into connecting base

Connection finished

2. Connection between screw tap and inlet hose.

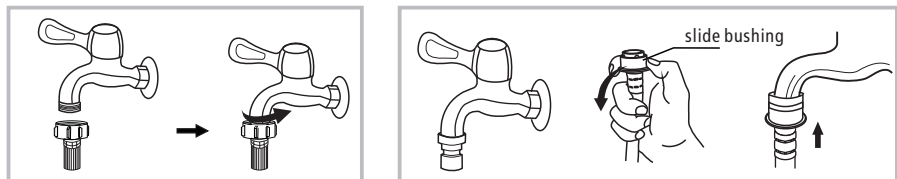

Tap with threads and inlet hose

Special tap for washing machine

INSTALLATION

Connect the other end of inlet pipe to the inlet valve at the backside of product and fasten the pipe tightly clockwise.

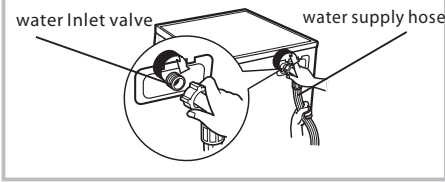

Drain Hose

⚠ Warning!

- Do not kink or protract the drain hose.
- Position drain hose properly ,otherwise damage might result of water leakage.

Firstly install the drain hose to the back side of machine. Then hold the drain hose with the clamp.

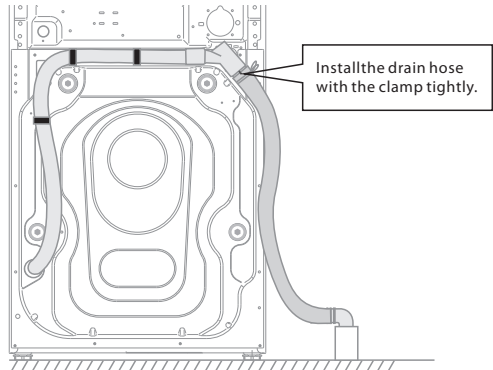

There are two ways to place the end of drain hose:

1. Put it into the drain port.

2. Connect it to the branch drain pipe of the trough.

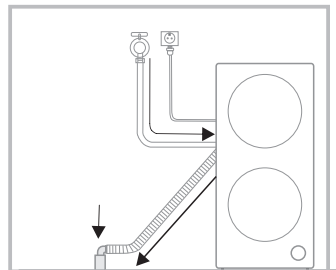
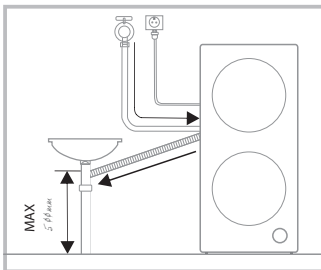

OPERATIONS

■ Quick Start

⚠ Caution!

- Before washing, please make sure it's installed properly.
- Before washing at first time, the washing machine shall be operated in one round of the whole procedures without clothes in as follows. The suggested program is "DRUM CLEAN".

1. Before Washing

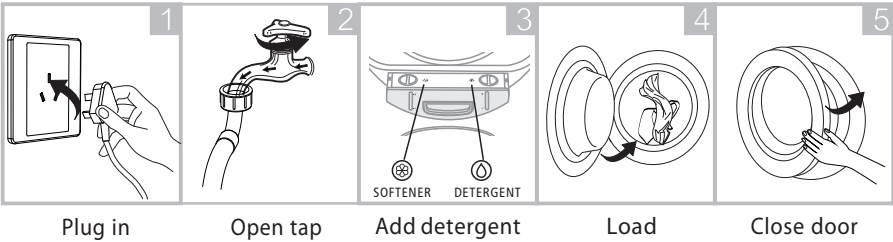

📌 Note!

- Add detergent or softener when the display shows note like this "Detergent and Softener have run out, please add!"

2. Washing

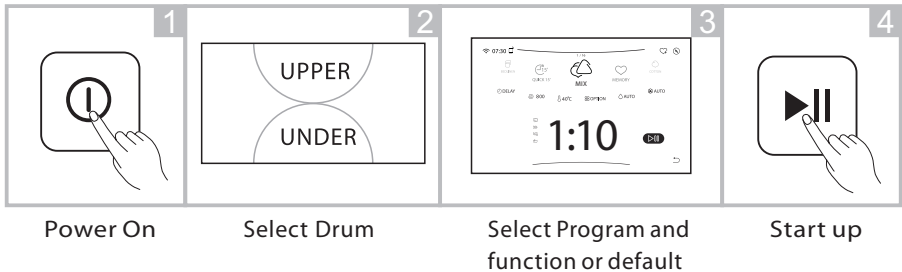

📌 Note!

- You can operate Upper & Under drum at the same time.
- When the machine is working, you can touch the display to lighten the display screen and drum lamp.

3. After Washing

Buzzer beep or "END" on display.

OPERATIONS

■ Before Each Washing

- The working condition of the washer should be (0-40)°C. If used under 0°C, the inlet valve and draining system may be damaged. If the machine is placed under condition of 0°C or less, then it should be transferred to normal ambient temperature to ensure the water supply hose and drain hose are not frozen before use.
- Please check the labels and the explanation of using detergent before wash. Use non-foaming or less-foaming detergent suitable for machine washing properly.

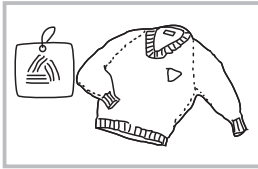

Check the label

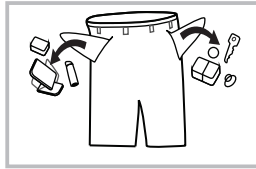

Take out the items out of the pockets

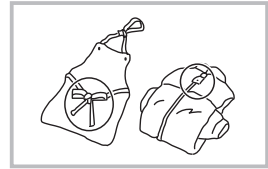

Knot the long strips, zip or button

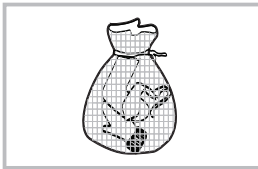

Put small clothes into the pillow slip

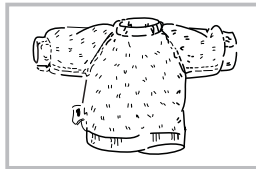

Turn easy-pilling and long-pile fabric inside out

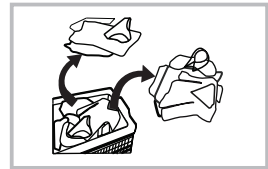

Separate clothes with different textures

⚠ Warning!

- When washing a single clothes, it may easily cause great imbalance and give alarm. Therefore it is suggested to add one or two more clothes to be washed together so that washing process can be done smoothly.
- Don't wash the clothes soaked in kerosene, gasoline, alcohol and other flammable materials.

OPERATIONS

■ Detergent Dispenser



Liquid detergent

Softener

If you want to use powder detergent, you can add it directly into the drum with clothes by using the container. Please put the container on the top of the load to make powder well dissolved.

Please make sure there is no liquid detergent in the dispenser, when using powder detergent.

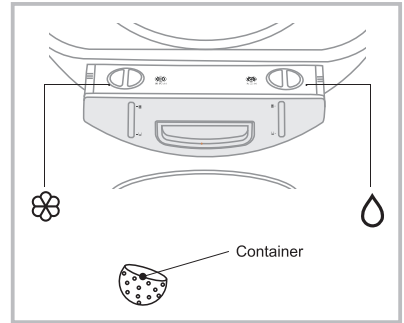

Pull out the dispenser

Add Detergent & softener

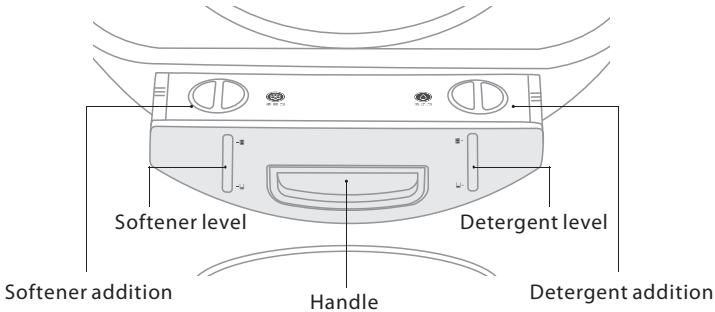

Note!

- As for the agglomerated or ropy detergent or additive, before they are poured into the detergent box, it is suggested to use some water for dilution to prevent the inlet of detergent box from being blocked and overflowing while filling water.
- Please choose suitable type of detergent for the various washing temperature to get the best washing performance with less water and energy consumption.
- Pay attention to whether the detergent is dry, and clean the dispenser regularly especially when the washing machine is not used for long periods of time.

OPERATIONS

■ Control Panel

Turn on the Machine , The display show "UPPER"&"UNDER"Mode.
You can touch the screen to select "UPPER" or "UNDER"Drum.

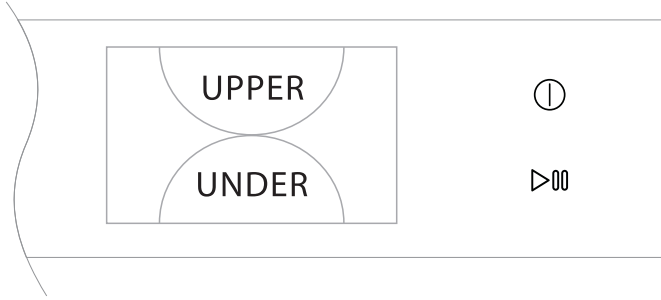

"UPPER"and "UNDER"Drum operation display, you can touch and slide to choose program and option.

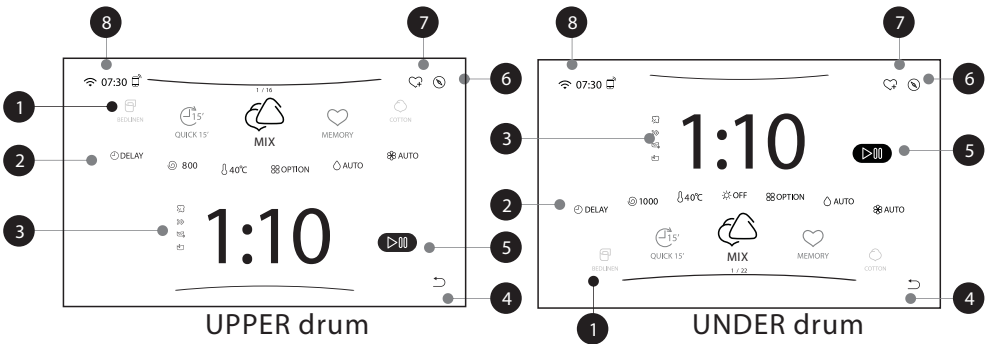

1	Program	5	Start / Pause
2	Option	6	Setting button
3	Display time	7	Memory function
4	Return button	8	Function icon (Wi-Fi, time , remote control)

📌 Note!

- The chart is for reference only, Please refer to real product as standard.

OPERATIONS

■ Option



DELAY

Set the Delay function:

1. Select a programme
2. Press the DELAY button to choose the time (the delaying end time is 1-24 H.)
3. Press [START/PAUSE] to commence the delay operation

Cancel the Delay function:

Touch the "off" to cancel delay function.

Caution!

- The DELAY time is washing finish time. If delay time is 3H, means the program will be finish at 3hours later.
- If there is any break in the power supply while the machine is operating, a special memory stores the selected programme and when the power is restarted, the machine will run the previous program automatically.
- While DELAY is set, If there is any break in the power supply, the machine can't start up operation automatically. You should set it again.



SPIN

Press the button to change the spin speed.



TEMP.

Press the button to regulate the temperature (20°C, 30°C, 40°C, 60°C, 90°C).



DETERGENT

Press the button to select amount of detergent and turn off the function.



SOFTENER

Press the button to select amount of softener and turn off the function.
(Off-Less-Auto-More).

OPERATIONS



DRYING

Press the button to select drying level and select drying time (AUTO/EXTRA/30/60/90/120/180) The default level is AUTO.



Note!

- Drying hints
 - Clothes could be dried after spinning
 - To ensure quality dry the textiles, please classify them according to their kinds and the drying temperature.
 - Synthetic should be set the proper drying time .
 - If you want to iron the clothes after drying, please put them for a while.
- Clothes not suitable for drying
 - Particularly delicate items such as synthetic curtains, woolen and silk, clothes with metal inserts, nylon stockings, bulky clothes, such as anoraks, bedcovers, quilts, sleeping bags and duvets must not be dried.
 - Clothes padded with foam-rubber or materials similar to foam-rubber must not be machine dried.
 - Fabrics containing residues of setting lotions or hair sprays, nail solvents or similar solutions must not be machine dried in order to avoid the formation of harmful vapours.

OPERATIONS



OPTION

There are four useful option for your choice:
EXTRA RINSE,FAST WASH,PREWASH,STEAM.



EXTRA RINSE

The laundry will under go extra rinse once after you select it.



FAST WASH

The function can decrease the washing time.



PREWASH

The PREWASH function can get an extra wash before main wash,it is suitable for washing the dust rises to surface of the clothe.



STEAM

STEAM function can penetrate the fiber,which effectively eliminate bacterias and germs, preventing odors and protecting your health.



RELOAD

This operation can be executed during the washing process. When the drum is still rolling and there is large amount of water with high temperature in the drum. The state is unsafe and the door cannot be opened forcefully. To press Reload icon to reload, and small amount of clothes can be added during washing process. Please follow the steps as bellow:

- 1.Wait until the drum stops rotation.
- 2.The door lock is unlocked.
- 3.Open the door , add clothes to the drum, and close the door. Then press the [START/PAUSE] button.



Caution!

- Don't use the Reload function when the water level over the edge of the inner tub or the temperature is higher.
-



MEMORY

Memorizes the frequently used program.

Select program and options and Press , then the display will show

"Save success as Memory".The default is "MIX".The program after selection will cover the previous program.

OPERATIONS

■ Setting guide

- Touch the setting button “” to set some useful function.

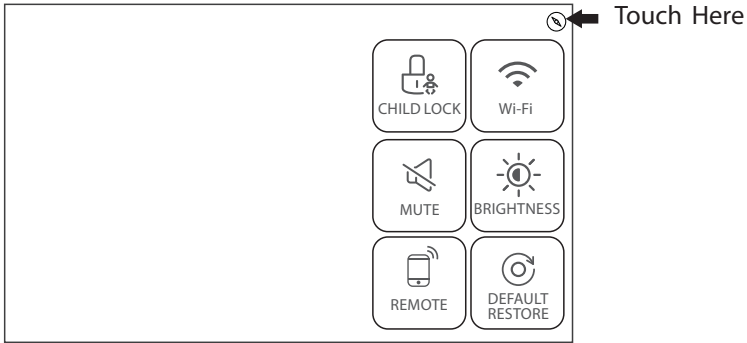

CHILD LOCK

Touch the “CHILD LOCK” to avoid mis operation by children.
If you want to cancel the “CHILD LOCK”,touch the display screen ,
it will show “unlock ” button,press 3 second to cancel this function.



Caution!

- The “CHILD LOCK” will lock all buttons except [ON/OFF].
- When the power supply is off, CHILD LOCK will be cancelled.



Mute the buzzer

Touch the “MUTE”,the buzzer is mute.
To activate the buzzer function, touch the button again .
The setting will be kept until the next reset.



Caution!

- After Muting the buzzer function, the sounds will not be activated any more.



BRIGHTNESS

Touch the “BRIGHTNESS” to adjust the brightness of display screen.



DEFAULT RESTORE

Touch the “DAFAULT RESTORE” to restore the factory default settings.

OPERATIONS

■ Setting guide



Wi-Fi

Touch the "Wi-Fi", the washing machine will be connected to the internet on your smartphone. The details of Wi-Fi connect, please check page 25. This is the Wi-Fi switch, if you want make your appliance connect to the internet. You need turn on the "Wi-Fi" button.



REMOTE

This is the switch of remote control, if you want to use your smartphone to control the washing machine remotely, you need touch "REMOTE" button. Considering the safe operation of washing machine, the smartphone remote control should meet the following conditions:

1. The appliance should connect to the internet;
2. The door of upper drum & under drum should be closed.

Remark:

- If the door is open in any time, the remote control function will be failure.
 - The remote control function is turned off at the end of each cycle automatically, if you want to use remote control function again, you need turn on it again.
-

OPERATIONS

■ Instructions to Connection with Toshiba HA App

Before you start, make sure that:

1. Your smartphone is connected to home WiFi network, and you know the network password.
2. You are next to the appliances.
3. The frequency of your wireless router is 2.4GHz (preferable) or 5GHz.
4. Initiate your mobile phone's Bluetooth and allows the APP to find your phone.

1 Download Toshiba HA App

Scan the QR code below or search for "Toshiba HA" in Google Play(Android devices) or App Store(ios devices) to download the app.



2 Register or Login account

Open the App and create a user account. If you already have one, just log in



3 Add your appliance

Click the "+" button, add your device according to the device model or choose the device found out by Bluetooth and add it.

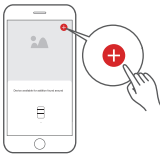

4 Connected to the network

Follow the instructions in the App to set up the WiFi connection. If the network connection fails, please refer to the App tips for operation.



⚠ Notes on Connection

- When networking the product, please make sure that the mobile phone is as close as possible to the product.
- According to the App tips, if the appliance could only connect to the 2.4GHz WiFi network, please note that the 2.4GHz network is now available.
- Toshiba recommends that you would better name your WiFi router SSID with letters and numbers only; otherwise, the SSID might become invalid if it is named with special characters, punctuation marks or spaces. After the SSID is available, please try to connect with WiFi, otherwise, please login the router and change the SSID name.
- If there is a large number of devices connecting with the WiFi router, the network stability might be affected. Toshiba is not obliged to advise you that how many devices you shall connect you're your WiFi router, for it depends on router quality and many other factors.
- If the router is replaced or WiFi name or password is revised, please carry out the steps abovementioned again for WiFi connection.
- When the product technology is updated, Toshiba HA may be changed, but what the content shown in the Toshiba HA shall prevail.

OPERATIONS

■ **Programmes** Programmes are available according to the laundry type.

Under Drum Program

MIX	Mixed Load of Cotton and Synthetic
SANITIZE	Continuous 60°C sterilization
THE GREATWAVES	Prevent Decoloring From Dark or Colorful Clothing
QUICK 15'	Wash Lightly Soiled and Small Loads
SPIN ONLY	Spin Only Program
QUICK 30'	Wash Lightly Soiled and Small Loads
UNDERWEAR	Special Care Wash for Underwear
DRY ONLY	Automatically Drying
DRUM CLEAN	High Temperature Self-Clean Program
1H WASH AND DRY	Wash and Dry Small Loads
RINSE & SPIN	Rinse and Spin Program
COTTON	Cotton Fabric Washing Program
BEDLINEN	Wash Large and Heavily Soiled Laundry
WOOL	Especially Gentle Wash Programme Hand or Machine-washable Wool or Richwool Textiles.
REFRESH	Refresh to Remove Odor
WASH & DRY	This Program is Designed for Washing & Drying clothes
DOWN	Special Care Wash Down Jacket
QUICK DRY	Dry Small Loads
SHIRT	Special Care Wash for Shirt
OUTDOOR	Special Care Wash for Outdoor clothes
MEMORY	To Memorize the Frequently Used Program

*“COTTON , 60°C,MAX rpm” is the recommended washing program designed to minimize water consumption for normally soiled load at rated capacity.

OPERATIONS

■ **Programmes** Programmes are available according to the laundry type.

Upper Drum Program

MIX	Mixed Load of Cotton and Synthetic
SANITIZE	Continuous 60°C Sterilization
QUICK 15'	Wash Lightly Soiled and Small Loads
BABY CARE	High Temperature Wash Baby Clothes
SPIN ONLY	Spin Only Program
QUICK 30'	Wash Lightly Soiled and Small Loads
UNDERWEAR	Special Care Wash for Underwear
DRUM CLEAN	High Temperature Self-Clean Program
RINSE & SPIN	Rinse and Spin Program
COTTON	Cotton Fabric Washing Program
WOOL	Especially Gentle Wash Programme Hand or Machine-washable Wool or Richwool Textiles.
THE GREAT WAVES	Prevent Decoloring From Dark or Colorful Clothing
SHIRT	Special Care Wash for Shirt
SILK	Special Care Wash for Silk
MEMORY	To Memorize the Frequently Used Program

*“COTTON , 60°C,MAX rpm” is the recommended washing program designed to minimize water consumption for normally soiled load at rated capacity.



“The wool wash cycle of this machine has been approved by The Woolmark Company for the washing of wool garments labelled as “hand wash” provided that the products are washed according to the instructions on the garment label and those issued by the manufacturer of this washing machine.”
M2015:MFFT150-DUU1420BIP/Q27TW-SG(Upper Drum)
M1912:MFFT150-DUU1420BIP/Q27TW-SG(Lower Drum)

OPERATIONS

■ Washing Programmes Table

UPPER			
Program	Load(kg)	Default Temp.(°C)	Default Time
MIX	5	40	1:10
SANITIZE	1	60	2:39
BABY CARE	4	60	2:05
QUICK 15'	1	Cold	0:15
SHIRT	2.5	30	0:58
WOOL	1	40	1:22
SPIN ONLY	5	-	0:12
DRUM CLEAN	--	90	1:18
COTTON	5	40	1:18
UNDERWEAR	2.5	30	1:35
QUICK 30'	1	20	0:30
RINSE & SPIN	5	-	0:20
SILK	1	30	0:50
GREAT WAVES	2.5	Cold	1:03



Note!

- The parameters in this table are only for user's reference. The actual parameters may be different with the parameters in above mentioned table.

OPERATIONS

■ Washing Programmes Table

UNDER			
Program	Load(kg) Wash/Dry	Default Temp.(°C)	Default Wash Time
MIX	10.0 / 7.0	40	1:10
SANITIZE	3.0 / 3.0	60	2:39
QUICK 15'	2.0 / -	Cold	0:15
SHIRT	5.0 / 5.0	30	0:58
WOOL	2.0 / -	40	1:03
SPIN ONLY	10.0 / -	-	0:12
DOWN	2.0 / -	40	1:27
DRUM CLEAN	--	90	1:18
COTTON	10.0 / 7.0	40	1:18
UNDERWEAR	5.0 / 5.0	30	1:35
QUICK 30'	2.0 / -	20	0:30
RINSE & SPIN	10.0 / -	-	0:20
GREATWAVES	5.0 / -	Cold	1:03
OUTDOOR	5.0 / 5.0	30	1:31
BEDLINEN	10.0 / 7.0	40	1:48
DRY ONLY	- / 7.0	-	3:00
1H WASH&DRY	1.0 / 1.0	Cold	0:59
QUICK DRY	- / 1.0	-	0:35
REFRESH	- / 1.0	-	0:30
WASH&DRY	7.0 / 7.0	40	4:30 *

*Wash and Dry Time



Note!

- The parameters in this table are only for user's reference. The actual parameters maybe different with the parameters in above mentioned table.

MAINTENANCES

Note!

- In the program " DRY ONLY", you can touch  button to change drying duration (30min, 60min, 90min, 120min), suitable for different loading (0.5kg, 1kg, 1.5kg, 2kg).This program contains 10 minutes of default dehydration time, so the actual display time is 40min, 70min, 100min, 130min.
- For " DRY ONLY" program,the default display time can be different from actual time.Because actual time will be adjusted automatically by load or texture.
Drying time for reference:

Cotton fabric(kg)	3kg	4kg	5kg	6kg	7kg
Estimated time(min.)	150'	200'	230'	270'	300'

- The parameters in this table are only for user's reference.The actual parameters maybe different with the parameters in above mentioned table.

MAINTENANCES

■ Cleaning And Care

Warning!

- Before your maintenance starts, please unplug the machine and close the tap.

Cleaning The Cabinet

Proper maintenance on the washing machine can extend its working life. The surface can be cleaned with diluted non-abrasive neutral detergents when necessary. If there is any water overflow, use the dry cloth to wipe it off immediately. No sharp items are allowed.

Note!

- Formic acid and its diluted solvents or equivalent are forbidden, such as alcohol, solvents or chemical products, etc.

Cleaning The Drum

The rusts left inside the drum by the metal articles shall be removed immediately with chlorine-free detergents. Never use steel wool.

Note!

- Don't put laundry in the washing machine during the drum cleaning.

MAINTENANCES

Cleaning The Gasket And Glass

Wipe the glass and gasket after each wash to remove lint and stains. If lint builds up it can cause leaks.

Remove any coins, buttons and other objects from the gasket after each wash.

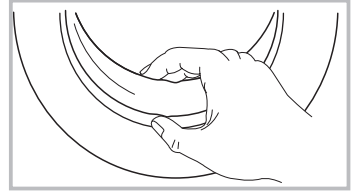

Cleaning The Inlet Filter

Note!

- Inlet filter must be cleaned if there is less water.

Washing the filter in the water supply hose

1. Close the tap.
2. Remove the water supply hose from the tap.
3. Clean the filter.
4. Reconnect the water supply hose.

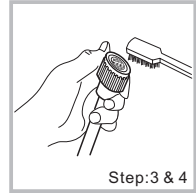
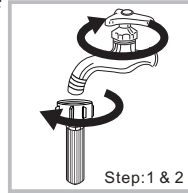

Washing the filter in washing machine:

1. Screw off the inlet pipe from the backside of the machine.
2. Pull out the filter with long nose pliers and reinstall it back after being washed.
3. Use the brush to clean the filter.
4. Reconnect the inlet pipe.

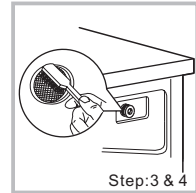

Clean The Detergent Dispenser

1. Pull out the dispenser drawer with press "A" as indicated in Figure 1.
2. Take out of detergent & softener cover and wash with water.
3. Clean inside the recess with a suitable brush such as an old toothbrush.
4. Restore the cover and push the drawer into position.

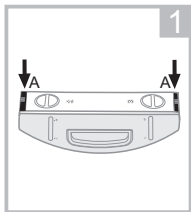

Pull out the dispenser drawer with press the A

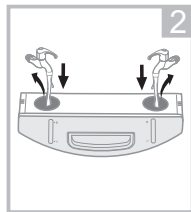

Clean the dispenser drawer under water

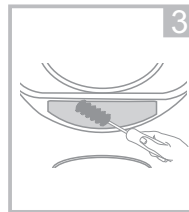

Clean inside the recess with an old toothbrush

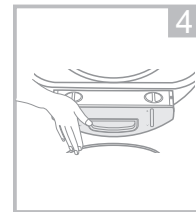

Insert the dispenser drawer

MAINTENANCES

Note!

- Do not use alcohol, solvents or chemical products to clean the machine.

Cleaning The Drain Pump Filter

Warning!

- Be careful of the hot water!
- Wait for the water to cool down.
- Unplug the machine to avoid electrical shock before maintenance.
- Drain pump filter can filter the lints and small foreign matters from the washing.
- Clean the filter periodically to ensure the normal operation of washing machine.

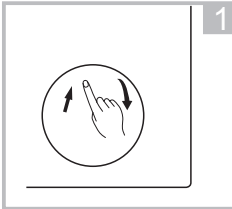

Open the lower cover cap

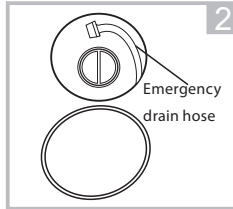

Pull out the emergency drain hose, and take off the hose cap.

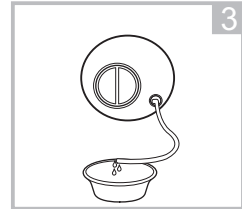

After water runs out, reset the drain hose

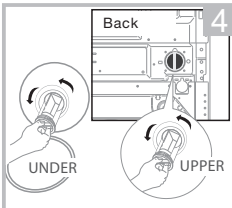

Open the upper or under filter cap by turning to the counter clockwise

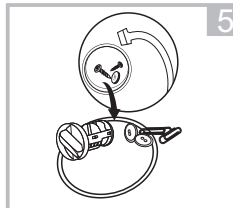

Remove extraneous matter

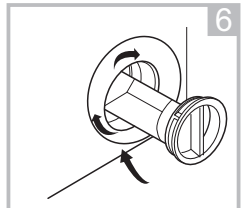

Close the upper and under filter cap and the lower cover cap.

Caution!

- Make sure that upper and under filter cap and emergency drain hose are reinstalled properly, filter cap should be inserted aligning to hole plates otherwise water may leak.
- When the appliance is in use and depending on the programme selected there can be hot water in the pump. Never remove the pump cover during a wash cycle, always wait until the appliance has finished the cycle, and is empty. When replacing the filter cap, ensure it is securely re-tightened.

MAINTENANCES

■ Trouble Shooting

The start of the appliance does not work or it stops during operation. First try to find a solution to the problem, If not, contact the service centre.

Description	Reason	Solution
Washing machine cannot start up	Door is not closed properly	Restart after the door is closed Check if the clothes is stuck
Door can't be opened	Washer's safety protection design is working	Disconnect the power, restart the product
Water leakage	The connection between inlet pipe or outlet hose is not tight	Check and fasten water pipes Check outlet hose
Display screen does not light	Electrical power cord may not be plugged in or connection may be loose.	Make sure plug fits tightly in wall outlet. Check the power plug is connected correct.
Abnormal noise		Check if the transport bolts have been removed Check it's installed on a solid and level floor

Description	Reason	Solution
E30	Door is not closed properly	Restart after the door is closed Check if the clothes is stuck
E10	Water injecting problem while washing	Check if the water pressure is too low Straighten the water pipe Check if the inlet valve filter is blocked
E21	Overtime water draining	Check if the drain hose is blocked
E12	Water overflow	Stop using the washing machine and call the service center for repair
EXX	Others	Please try again first, call up service line if there are still troubles

Note!

- After the check, turn off and trun on the machine. If the problem occurs or the display shows other alarm codes again, contact the service.

MAINTENANCES

■ Technical Specifications

Power Supply 220V-240V~,50Hz

MAX.Current 10A

Standard Water Pressure 0.05MPa~1MPa

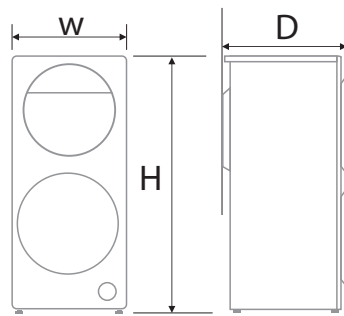

Model	Upper Drum Washing Capacity	Under Drum Washing Capacity		Under Drum Dry Capacity
TWD-BL160D4 Series	5.0kg	10.0kg		7.0kg
	Dimension (W*D*H mm)	Net Weight	Rated Power	Dry Power
	600*630*1350	116kg	2000W	1300W